

EL ALFS series

ALFS2BD-C0PA07001L1-AM



Features

- Package : SMD ceramic package
- Typ. Cool White Color Temperature : 5850K
- Typ. PC Amber Chromaticity Coordinates : CIE $x = 0.57$ 、 CIE $y = 0.42$
- Typ. Luminous Flux (Cool White) : 260 lm @ 700mA / (PC Amber) : 160 lm @ 700mA
- Viewing angle : 120°
- ESD : up to 8KV
- MSL : 2
- Qualifications : According to AEC-Q102
- The product itself will remain within RoHS compliant version.
- Compliance with EU REACH.
- Compliance Halogen Free.(Br <900 ppm ,Cl <900 ppm , Br+Cl < 1500 ppm).
- Sulfur robustness

Applications

- Automotive Exterior Lighting
- Daytime running light (DRL)
- Turning lamp

Contents

1. Characteristics	3
2. Absolute Maximum Ratings	4
3. Characteristics Graph.....	5
4. Binning Information	14
5. Part Number	19
6. Ordering Information	20
7. Mechanical Dimension.....	21
8. Recommended Soldering Pad	22
9. Reflow Soldering Profile	23
10. Packaging Information	24
11. Precaution for Use	26

1. Characteristics

Parameter		Symbol	Min.	Typ.	Max.	Unit	Condition
Luminous Flux ^{[2][3]}	Cool White	Φ_v	220	260	300	lm	$I_F=700mA$
	PC Amber	Φ_v	120	160	200	lm	$I_F=700mA$
Forward Voltage ^{[4][5]}	Cool White	V_F	2.90	3.35	3.8	V	$I_F=700mA$
	PC Amber						
Viewing Angle	Cool White	ϕ	---	120	---	deg	$I_F=700mA$
	PC Amber						
Color	Cool White CCT	K	5180	---	6680	K	$I_F=700mA$
	PC Amber	CIE x	---	0.57	---	---	$I_F=700mA$
		CIE y	---	0.42	---		
Thermal Resistance (Junction to Solder)	Real	$R_{th JS real}$	---	4.6	9.0	K/W	$I_F=700mA$
	Electrical	$R_{th JS el}$	---	3.6	8.0		

Notes:

1. Forward condition by each of LED.
2. Luminous flux measurement tolerance: $\pm 8\%$.
3. The data of luminous flux measured at thermal pad=25°C
4. Forward voltage measurement tolerance: $\pm 0.05V$
5. The V_f range shown in the table above indicates 99% output.

2. Absolute Maximum Ratings

Parameter	Symbol	Ratings	Unit
Reverse Voltage	V_R	Not designed for reverse operation	V
Power Dissipation	P_d	5700	mW
Forward Current	I_F	1500	mA
Junction Temperature	T_J	150	°C
Operating Temperature	T_{opr}	-40 ~ +125	°C
Storage Temperature	T_{stg}	-40 ~ +125	°C
ESD Sensitivity (R=1.5kΩ, C= 100pF)	ESD_{HBM}	8	KV
Soldering Temperature	Reflow	260	°C

EVERLIGHT

3. Characteristics Graph

**Wavelength Characteristics Relative Spectral Distribution
@ T_S = 25°C 、 I_F = 700mA (CW)**

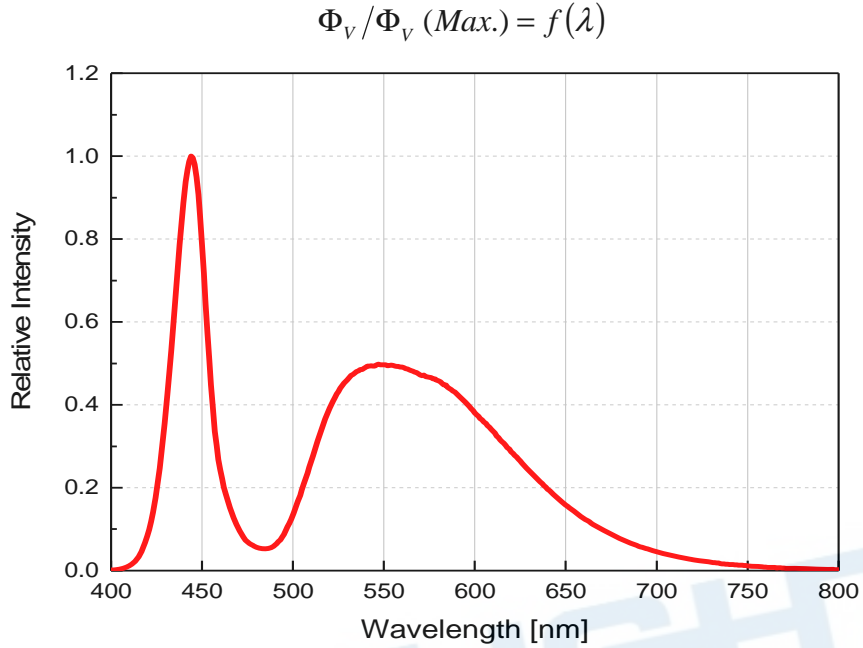

**Wavelength Characteristics Relative Spectral Distribution
@ T_S = 25°C 、 I_F = 700mA (PC Amber)**

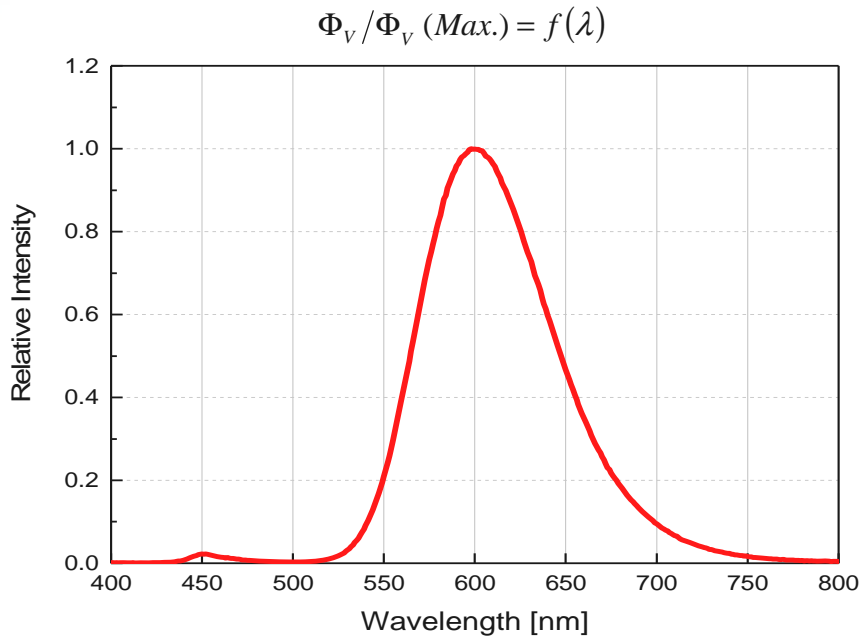

Typical Diagram Characteristics of Radiation (CW · PC Amber)

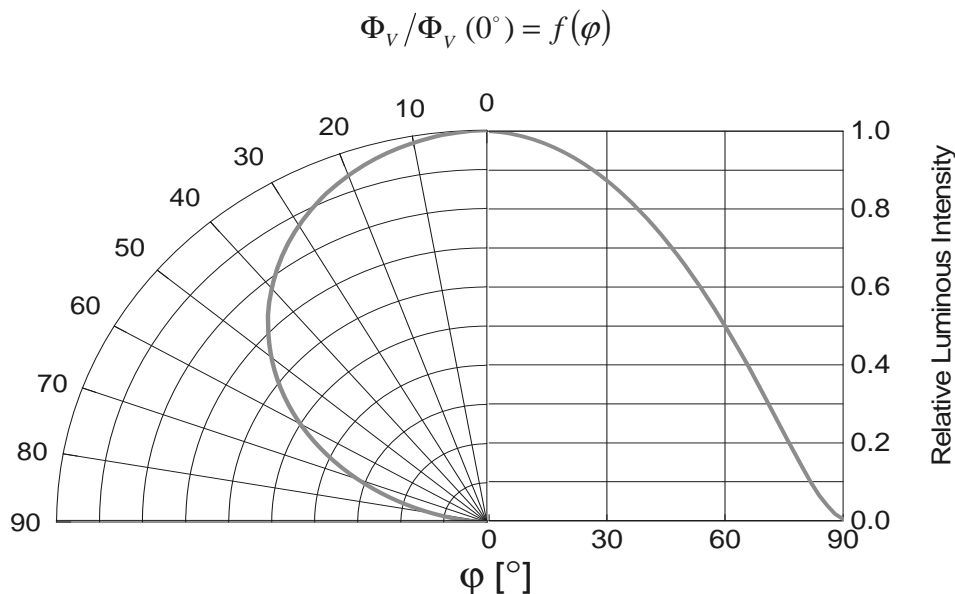

Notes:

1. φ is the off axis angle from lamp centerline where the luminous intensity is 1/2 of the peak value.
2. View angle tolerance is $\pm 5^\circ$

Forward Current vs. Forward Voltage @ $T_s = 25^\circ\text{C}$ (CW / PC Amber)

$$I_F = f(V_F)$$

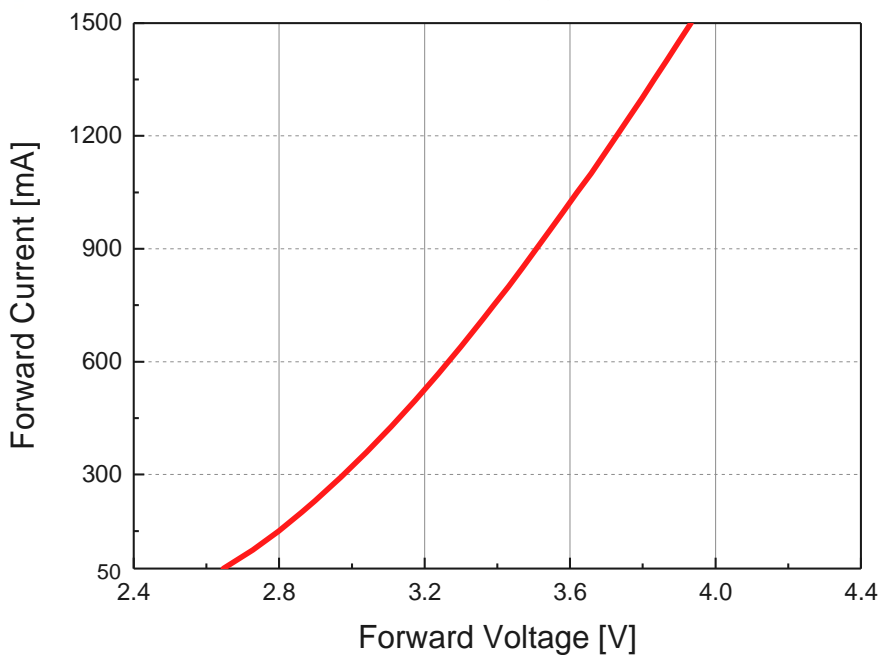

**Relative Luminous Flux vs. Forward Current
@ T_s = 25°C (CW)**

$$\Phi_V / \Phi_V (700mA) = f(I_F)$$

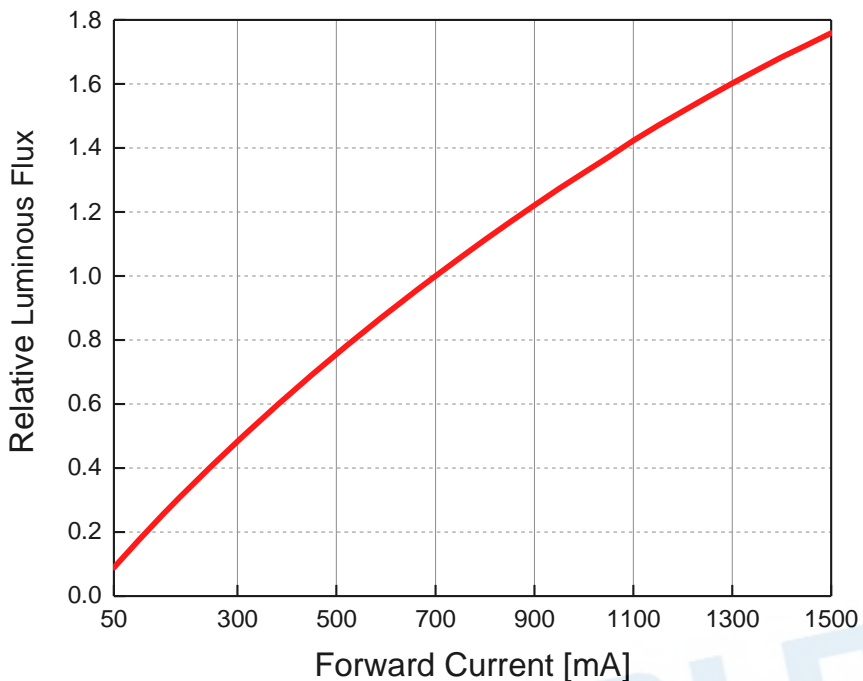

**Relative Luminous Flux vs. Forward Current
@ T_s = 25°C (PC Amber)**

$$\Phi_V / \Phi_V (700mA) = f(I_F)$$

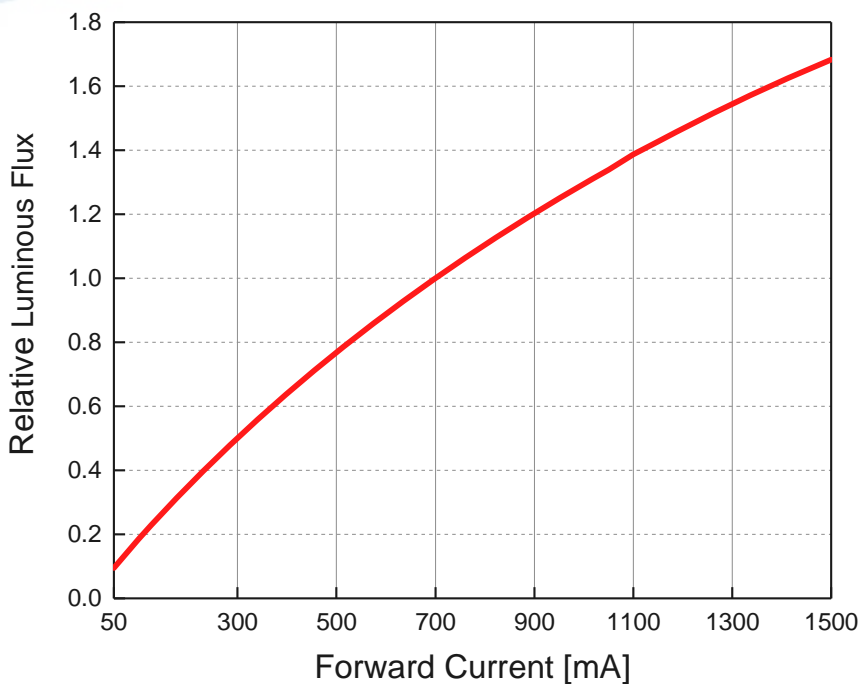

**Chromaticity Coordinates Shift vs. Forward Current
@ T_s = 25°C (CW)**

$$\Delta CIE x, \Delta CIE y = f(I_F)$$

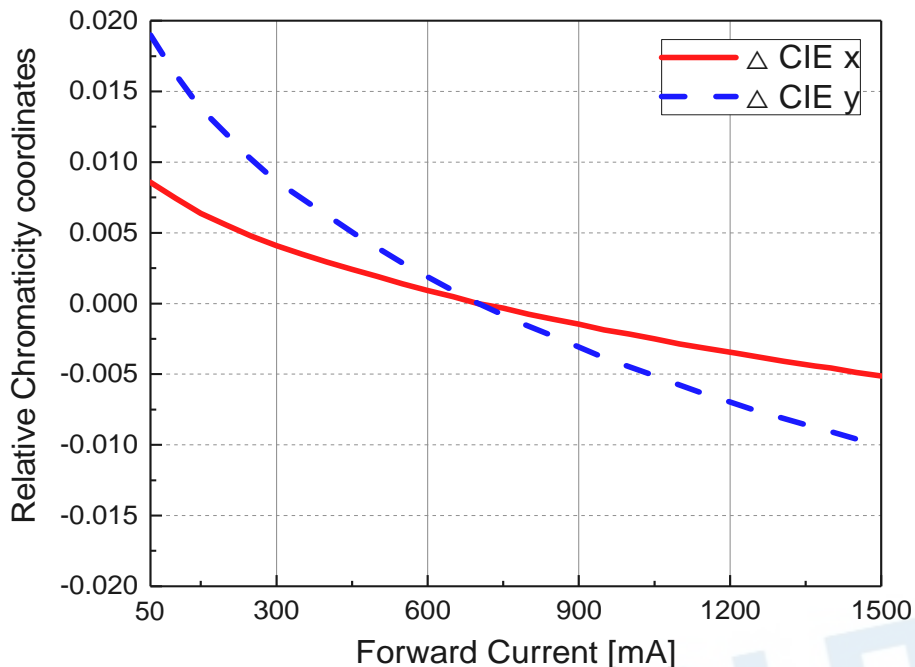

**Chromaticity Coordinates Shift vs. Forward Current
@ T_s = 25°C (PC Amber)**

$$\Delta CIE x, \Delta CIE y = f(I_F)$$

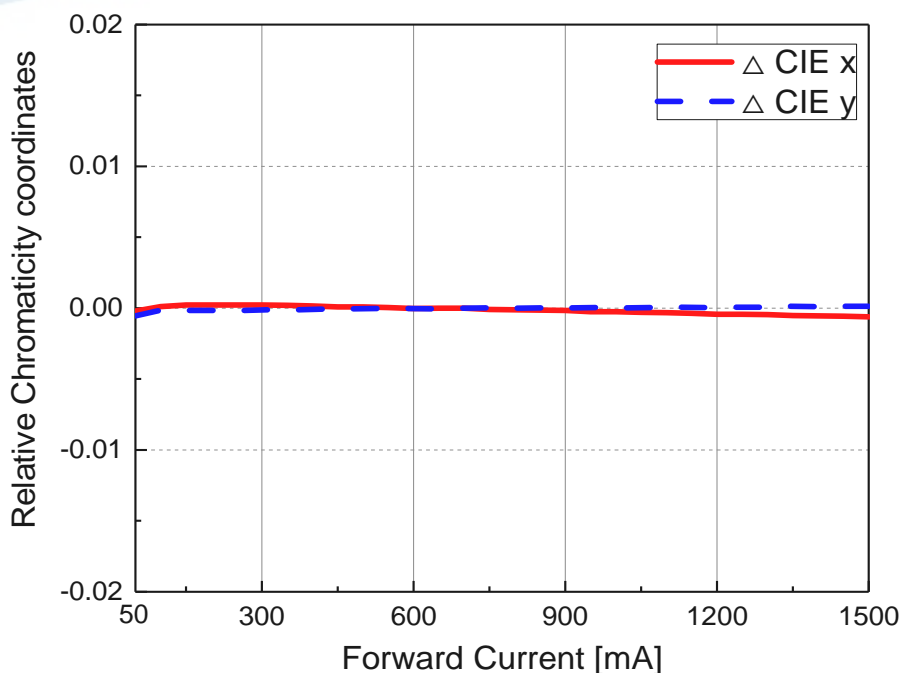

Relative Forward Voltage vs. Junction Temperature**@ $I_F = 700\text{mA}$ (CW / PC Amber)**

$$\Delta V_F = V_F - V_F(25^\circ\text{C}) = f(T_j)$$

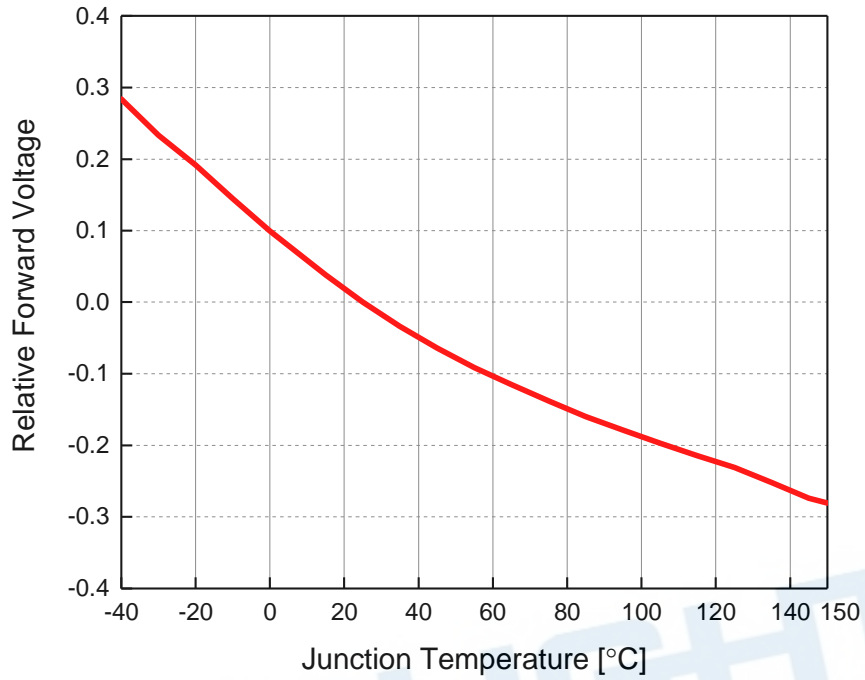

**Relative Luminous Flux vs. Junction Temperature
@ I_F = 700mA (CW)**

$$\Phi_V / \Phi_V(25^\circ C) = f(T_j)$$

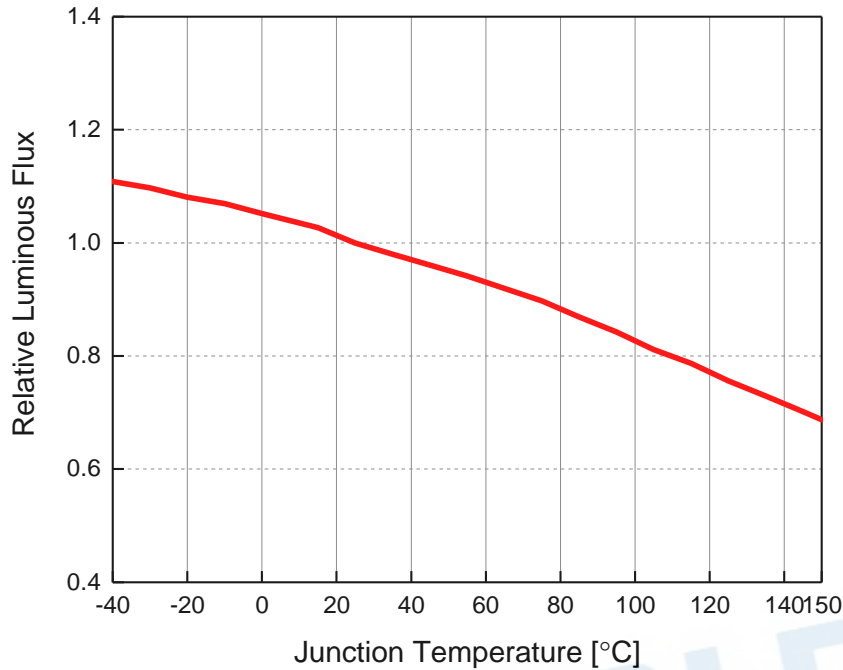

**Relative Luminous Flux vs. Junction Temperature
@ I_F = 700mA (PC Amber)**

$$\Phi_V / \Phi_V(25^\circ C) = f(T_j)$$

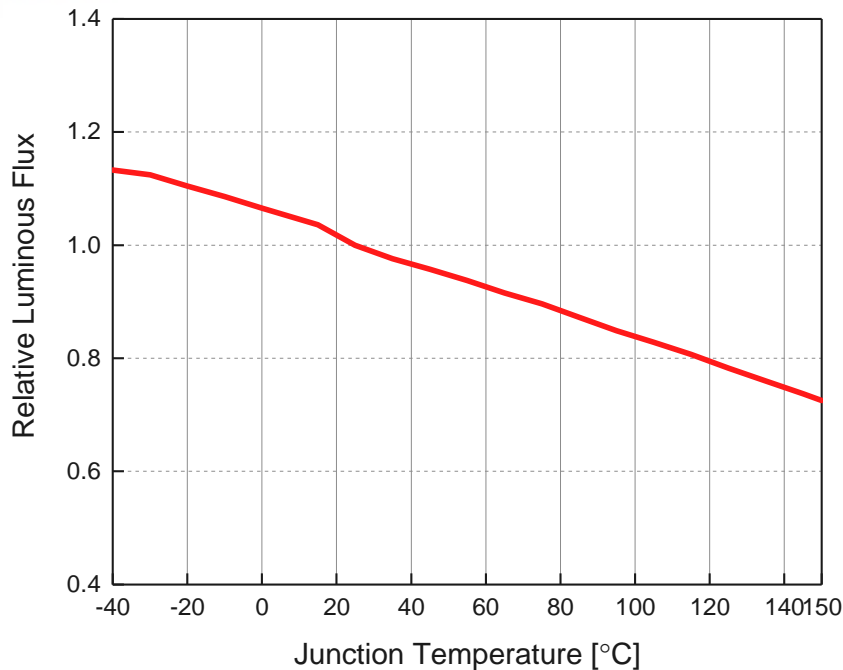

**Chromaticity Coordinates Shift vs. Junction Temperature
@ I_F = 700mA (CW)**

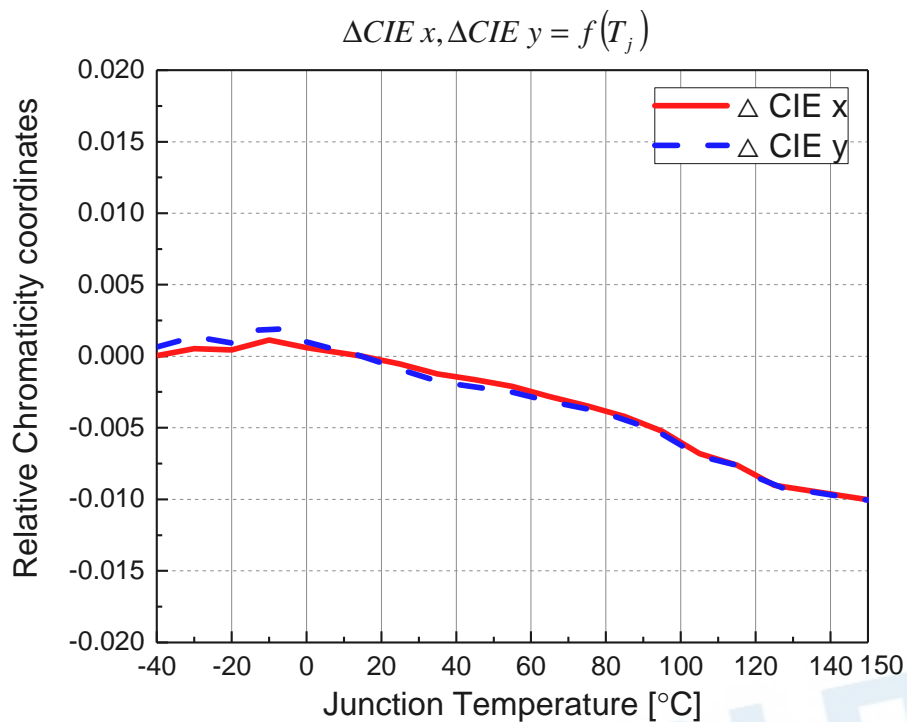

**Chromaticity Coordinates Shift vs. Junction Temperature
@ I_F = 700mA (PC Amber)**

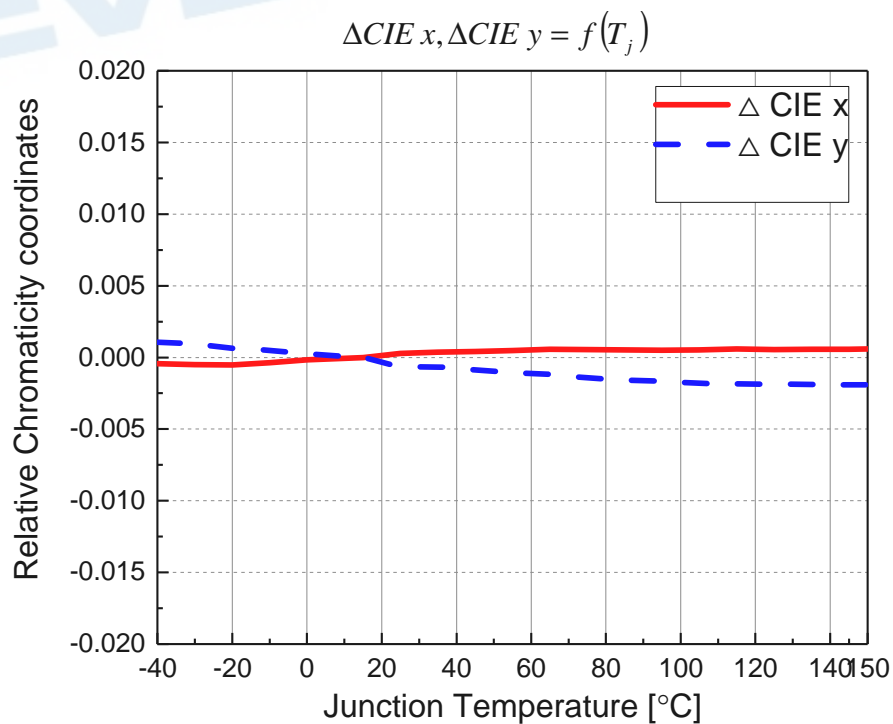

Forward Current Derating Curve

$$I_F = f(T_S)$$

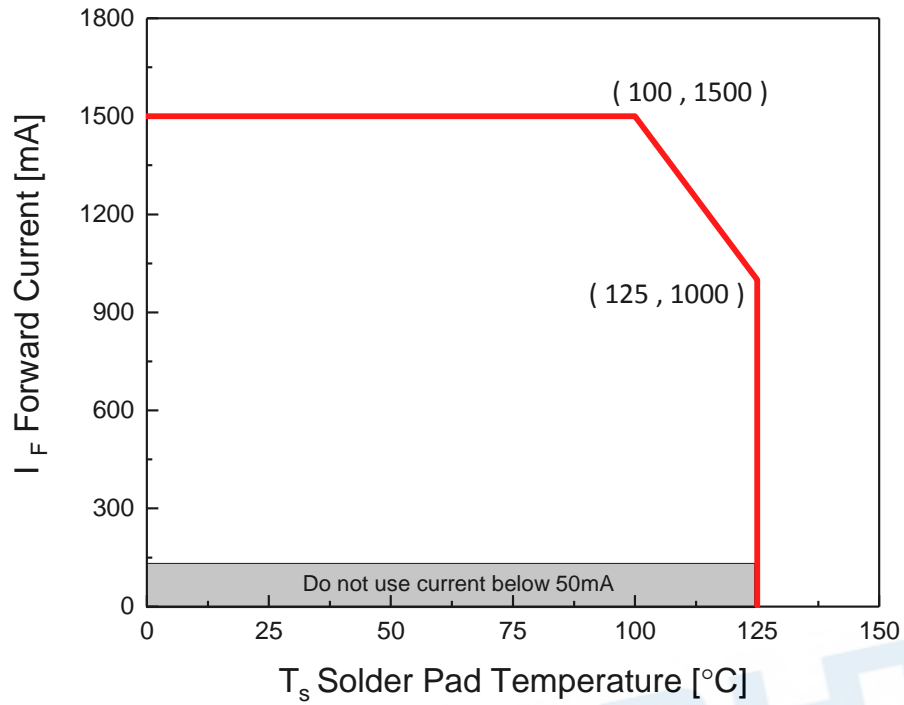

4. Binning Information

Luminous Intensity Bins

Group	Bin	Minimum Photometric Flux (lm)	Maximum Photometric Flux (lm)
B	1	100	120
	2	120	140
	3	140	160
	4	160	180
	5	180	200
	6	200	220
	7	220	240
	8	240	260
	9	260	280
	10	280	300

Notes:

- Luminous flux measurement tolerance: $\pm 8\%$
- Highlighted Black Box is available bins.
 PC Amber: 120 ~200
 Cool White: 220~300

Forward Voltage Bins

Group	Minimum Forward Voltage(V)	Maximum Forward Voltage(V)
1A	2.90	3.20
1B	3.20	3.50
1C	3.50	3.80

Notes:

1. Forward Voltage measurement tolerance: $\pm 0.05V$.

EVERLIGHT

Color Bin Structure
ECE Bin Structure

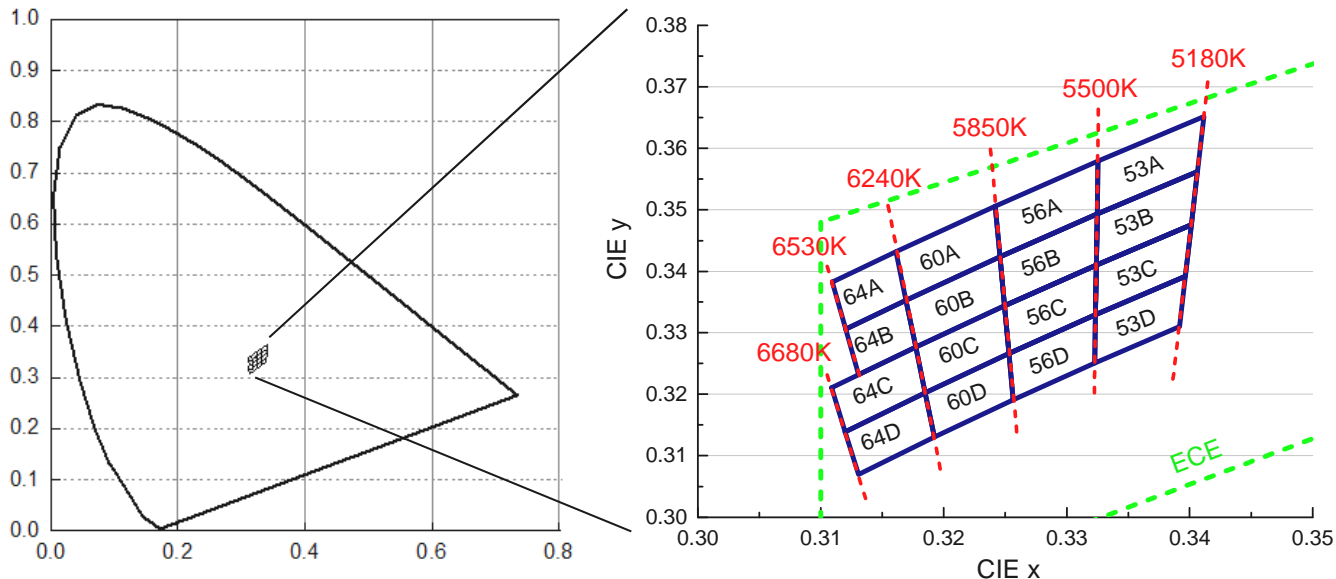

Cool White Bin Coordinates

Bin	CIE x	CIE y
64A	0.3109	0.3382
	0.3161	0.3432
	0.3169	0.3353
	0.3120	0.3306
Reference Range: 6240~6530K		

Bin	CIE x	CIE y
64B	0.3120	0.3306
	0.3169	0.3353
	0.3177	0.3277
	0.3131	0.3232
Reference Range: 6240~6530K		

Bin	CIE x	CIE y
64C	0.3109	0.3211
	0.3177	0.3277
	0.3185	0.3203
	0.3120	0.3139
Reference Range: 6240~6680K		

Bin	CIE x	CIE y
64D	0.3120	0.3139
	0.3185	0.3203
	0.3192	0.3131
	0.3131	0.3070
Reference Range: 6240~6680K		

Bin	CIE x	CIE y
60A	0.3161	0.3432
	0.3242	0.3506
	0.3246	0.3424
	0.3169	0.3353
Reference Range: 5850~6240K		

Bin	CIE x	CIE y
60B	0.3169	0.3353
	0.3246	0.3424
	0.3249	0.3344
	0.3177	0.3277
Reference Range: 5850~6240K		

Bin	CIE x	CIE y
60C	0.3177	0.3277
	0.3249	0.3344
	0.3253	0.3266
	0.3185	0.3203
Reference Range: 5850~6240K		

Bin	CIE x	CIE y
60D	0.3185	0.3203
	0.3253	0.3266
	0.3256	0.3191
	0.3192	0.3131
Reference Range: 5850~6240K		

Bin	CIE x	CIE y
56A	0.3242	0.3506
	0.3325	0.3579
	0.3325	0.3493
	0.3246	0.3424
Reference Range: 5500~5850K		

Bin	CIE x	CIE y
56B	0.3246	0.3424
	0.3325	0.3493
	0.3324	0.3410
	0.3249	0.3344
Reference Range: 5500~5850K		

Bin	CIE x	CIE y
56C	0.3249	0.3344
	0.3324	0.3410
	0.3323	0.3329
	0.3253	0.3266
Reference Range: 5500~5850K		

Bin	CIE x	CIE y
56D	0.3253	0.3266
	0.3323	0.3329
	0.3323	0.3251
	0.3256	0.3191
Reference Range: 5500~5850K		

Bin	CIE x	CIE y
53A	0.3325	0.3579
	0.3412	0.3652
	0.3406	0.3562
	0.3325	0.3493
Reference Range: 5180~5500K		

Bin	CIE x	CIE y
53B	0.3325	0.3493
	0.3406	0.3562
	0.3401	0.3476
	0.3324	0.3410
Reference Range: 5180~5500K		

Bin	CIE x	CIE y
53C	0.3324	0.3410
	0.3401	0.3476
	0.3396	0.3392
	0.3323	0.3329
Reference Range: 5180~5500K		

Bin	CIE x	CIE y
53D	0.3323	0.3329
	0.3396	0.3392
	0.3392	0.3310
	0.3323	0.3251
Reference Range: 5180~5500K		

Notes:

1. Color coordinates measurement tolerance: ± 0.005 .

Color Bin Structure ECE Bin Structure

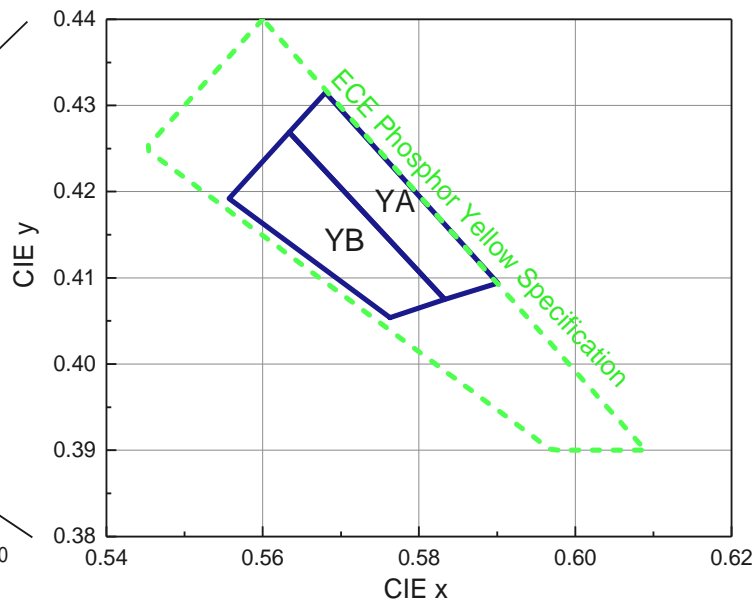
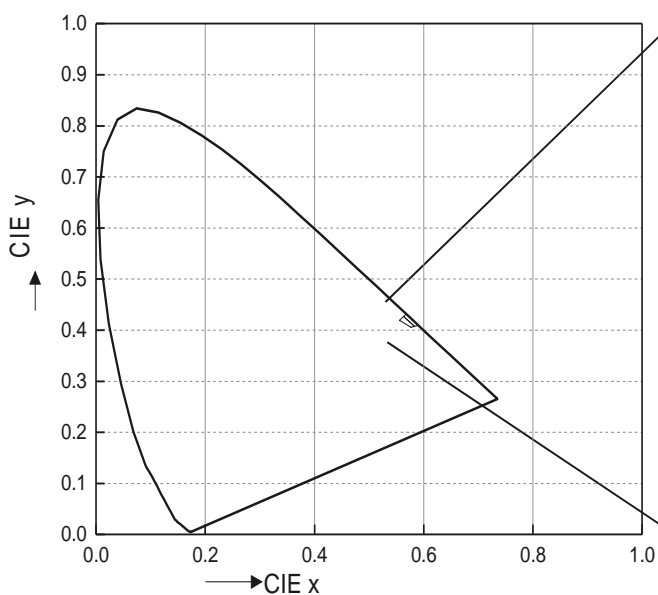

PC Amber Bin Coordinates

Bin	CIE x	CIE y
YA	0.5680	0.4315
	0.5634	0.4269
	0.5833	0.4075
	0.5901	0.4094

Bin	CIE x	CIE y
YB	0.5763	0.4054
	0.5833	0.4075
	0.5634	0.4269
	0.5557	0.4192

Notes:

1. Color coordinates measurement tolerance: ± 0.005 .

6. Part Number

ALFS2BD-C0PA07001L1-AM

Part number is designated with below details.

ALFS = product family name.

2 = chip number

B = Product type

D = Device

C = Color ^[1]

0 = CRI (0=N/A ; >70=7 ; >80=8 ; >90=9)

PA= color ^[1]

0700 = test current [mA]

1 = Metallic Plating Type (0=Ag ; 1=Au ; 2=MLP)

L1= Brightness Level

AM = automotive application

Note : ^[1] Color :

Symbol	Description
C	Cool White
N	Neutral White
W	Warm White
PA	Phosphor Converted Amber
PR	Phosphor Converted Red
UB	Blue
IB	Ice Blue
SB	Sky Blue
UP	Purple
UG	Green
UY	Yellow
UYG	Brilliant Yellow Green
UPG	Pale Green
UA	Amber
UR	Red
SR	Super Red
RGB	RGB-Color

7. Ordering Information

ALFS2BD-C0PA07001L1-ABC-DE-AM

Part Number of the ALFS	Order Code
ALFS2BD-C0PA07001L1-AM	ALFS2BD-C0PA07001L1-ABC-DE-AM

Order code contains information with below details :

ABC = Product emits 2 or more colors

DE = Internal code

AM = Automotive Application

Note :

[1] Group Bin chart :

Group Bin	Color	CIE-X Y	Φ_v	V_F
A00	CW	53A64D	B7B10	1A1C
	PA	YAYB	B2B5	1A1C

8. Mechanical Dimension

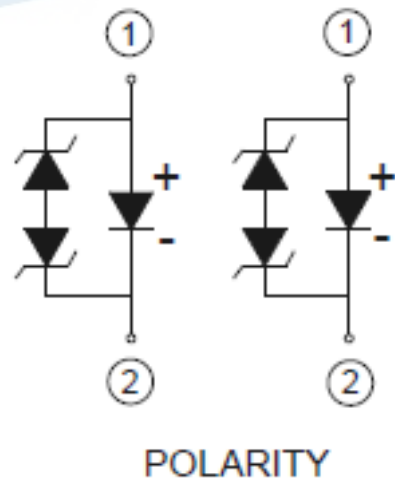
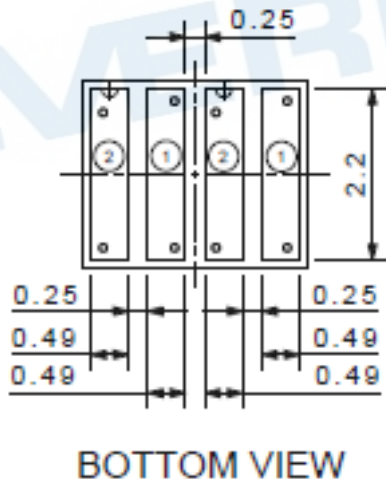
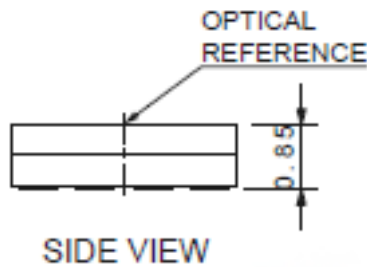
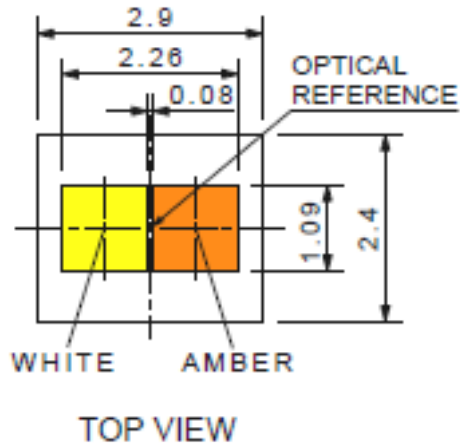

①	Anode
②	Cathode

Notes:

1. Dimensions are in millimeters.
2. Tolerances unless mentioned are $\pm 0.1\text{mm}$.

9. Recommended Soldering Pad

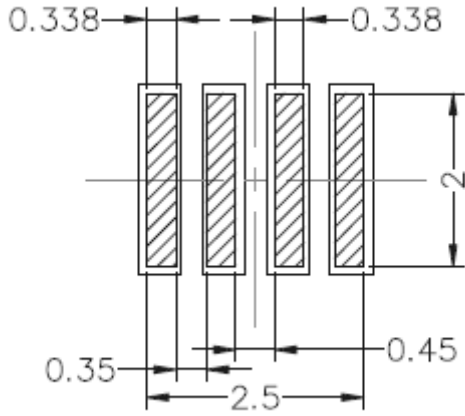

 solder stencil

EVERLIGHT

10. Reflow Soldering Profile

Soldering Condition (Reference: IPC/JEDEC J-STD-020D)

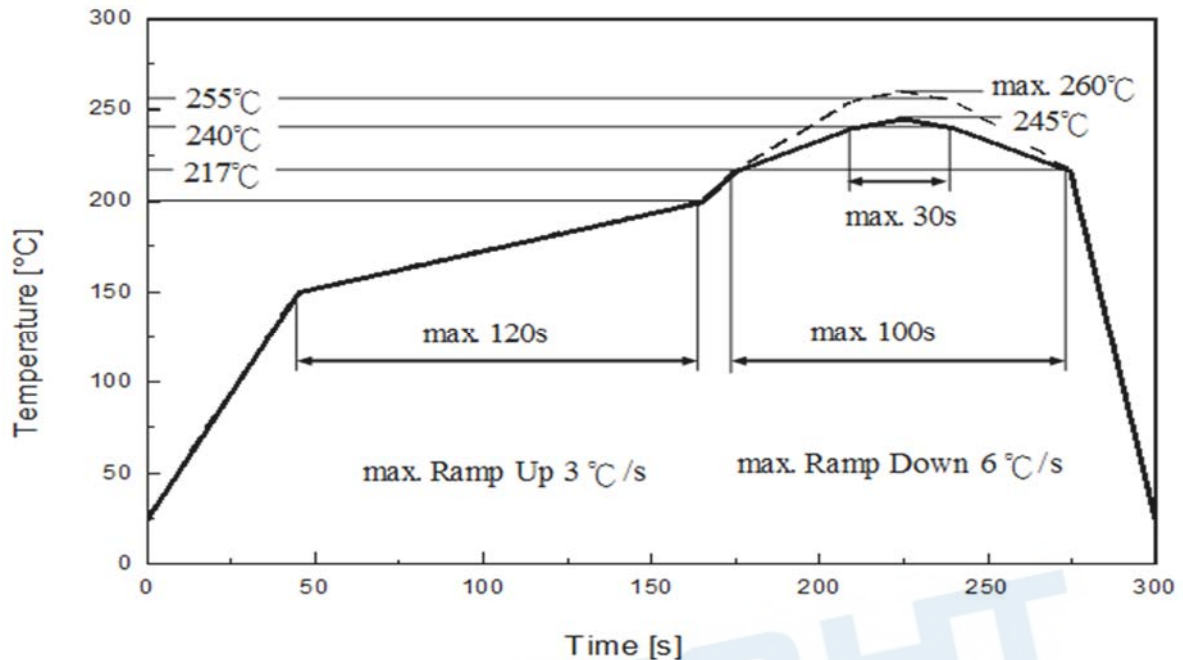

Profile Feature	Pb-Free Assembly	Unit Einheit
Ramp-up rate to preheat 25 °C to 150 °C	3	°C /sec
Time of soaking zone 150 °C to 200 °C	120	sec
Ramp-up rate to peak	3	°C /sec
Liquidus temperature	217	°C
Time above liquidus temperature	100	sec
Peak temperature (max.)	260	°C
Time within 5°C of the specified peak temperature	30	sec
Ramp-down Rate (max.)	6	°C /sec

10. Packaging Information

• Product Labeling

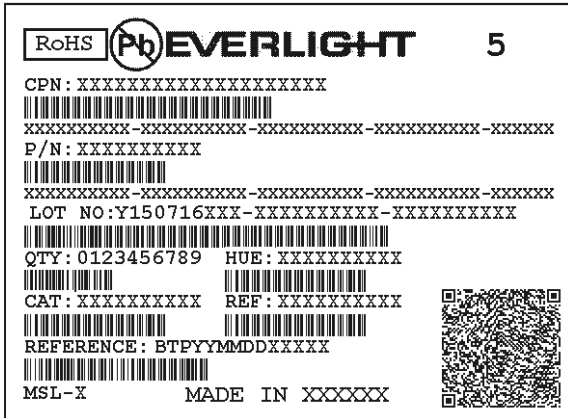

- CPN : Customer's Product Number
- P/N : Everlight Part Number
- LOT NO : Lot Number
- QTY : Packing Quantity
- HUE : Color Bin
- CAT : Luminous Flux (Brightness) Bin
- REF : Forward Voltage Bin

• Carrier Tape Dimensions as the following

Reel: 500pcs, MOQ_≥ 100pcs (has to be a multiple of 100pcs)

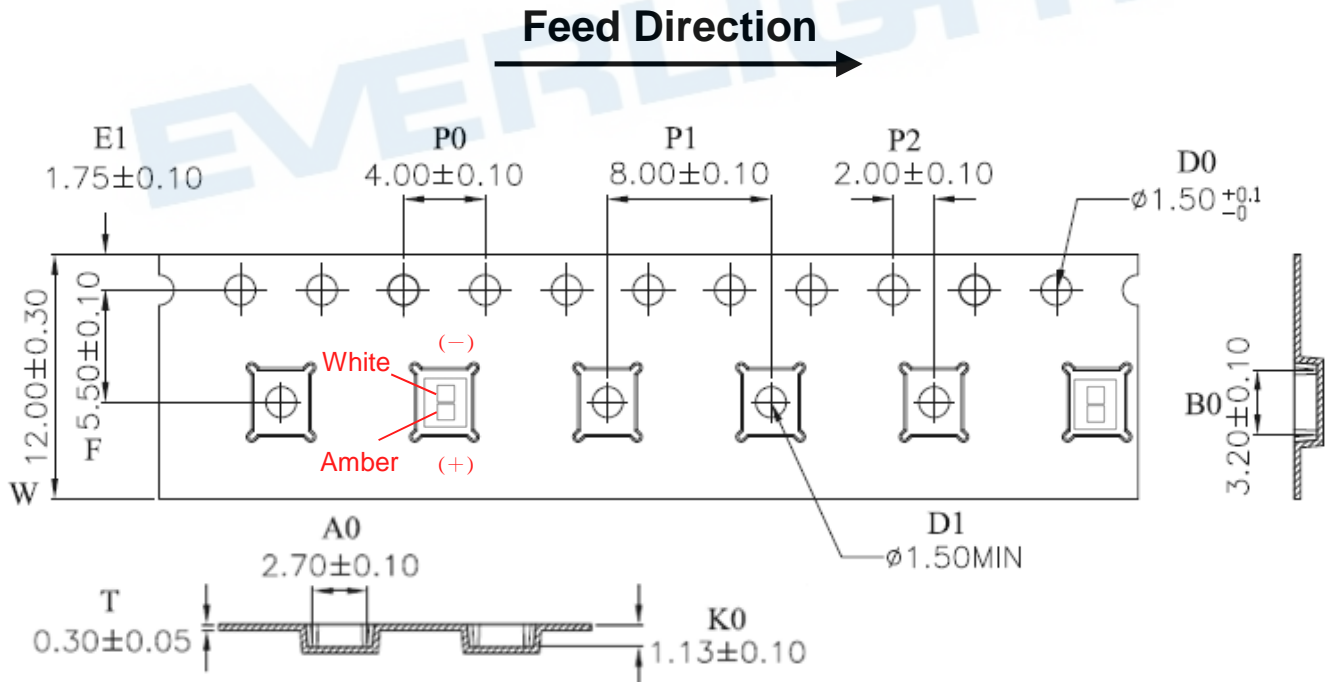

Notes:

1. Dimensions are in millimeters.

● **Reel Dimensions**

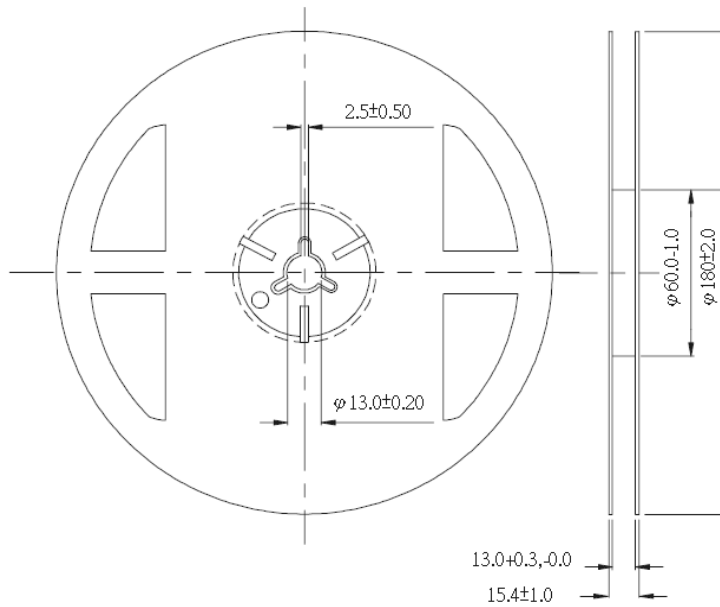

Notes:

1. Dimensions are in millimeters.

● **Moisture Resistant Packing Process**

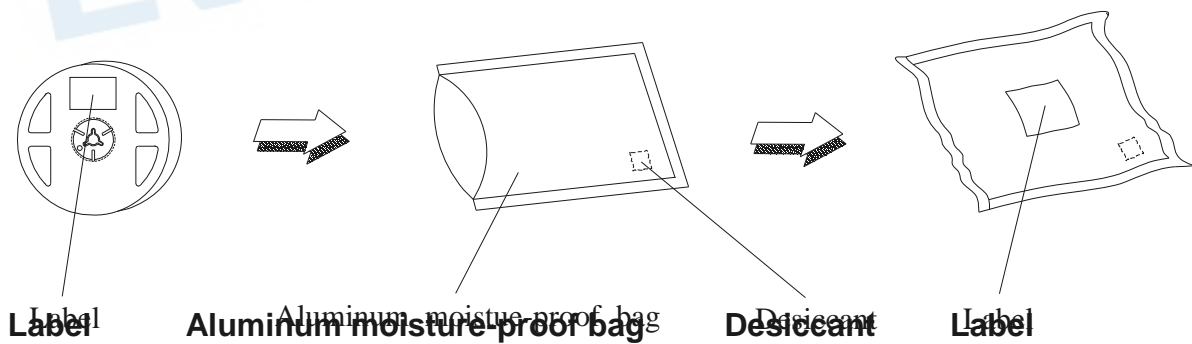

11. Precaution for Use

1. Over-current-proof

Customer must apply resistors for protection; otherwise slight voltage shift will cause big current change (burn out will happen).

2. Assemblies

Do not stack assemblies containing LEDs to prevent damage to the optical surface of LEDs. Forces applied to the optical surface may result in the surface being damaged.

3. Soldering Condition

3.1 When soldering, do not put stress on the LEDs during heating.

3.2 After soldering, do not warp the circuit board.

4. Soldering Iron

Each terminal is to go to the tip of soldering iron temperature less than 350°C for 3 seconds within once in less than the soldering iron capacity 25W. Leave two seconds and more intervals, and do soldering of each terminal. Be careful because the damage of the product is often started at the time of the hand solder.

5. Repairing

Repair should not be done after the LEDs have been soldered. When repairing is unavoidable, a double-head soldering iron should be used (as below figure). It should be confirmed beforehand whether the characteristics of the LEDs will or will not be damaged by repairing.

EVERLIGHT