

EVERLIGHT
EVERLIGHT
EVERLIGHT

DATASHEET

Shwo(F)

ELSWF-S41L2-6FPNM-DB4B6

“Shwo [Shuo] is the English translation for the Chinese word meaning Twinkle and is often used as a description of stars or other bright, celestial objects as seen from Earth. This word is a relevant description for this bright, compact Everlight LED package.”



Introduction

The Shwo(F) series is the latest version of our 3535 high-power surface-mount package, featuring an improved lens design for high brightness and photon emission.

The Shwo(F) series is one of the most efficient and competitive packages for horticultural applications.

Features

- ◆ Small ceramic SMD package
- ◆ ESD protection up to 8KV
- ◆ Color : 452.5nm (Royal Blue)
- ◆ Radiant Flux : Typ.1500mW @ 700mA
- ◆ Photosynthetic Photon Flux : 5.28 umole/s
- ◆ Moisture Sensitivity Level: 1
- ◆ Radiant Efficiency : 57.1%
- ◆ RoHS compliant
- ◆ The product itself will remain within RoHS compliant version.
- ◆ Compliance with EU REACH
- ◆ Compliance Halogen Free (Br < 900 ppm, Cl < 900 ppm, Br+Cl < 1500 ppm)

Applications

- ◆ Decorative and Entertainment Lighting
- ◆ Signal and Symbol Lighting
- ◆ Agriculture Lighting

Table of Contents

Absolute Maximum Ratings	4
JEDEC Moisture Sensitivity	4
Luminous Flux Characteristics for the Shwo series	4
PN of the Shwo series: Color LEDs	5
Optical Characteristics	6
Mechanical Dimension	7
Pad Configuration	8
Wavelength Characteristics	10
Typical Light Output Characteristic V.S. Thermal Pad Temperature	10
Typical Electrical Characteristics	11
Typical Relative Luminous Flux V.S. Forward Current.....	11
Typical Wavelength & Forward Current	12
Current Derating Curves	18
Current Derating Curves	12
Typical Radiation Patterns	13
Emitter Tape Packaging.....	14
Emitter Reel Packaging	15
Product Labeling	15
Storage Conditions	16
DISCLAIMER.....	17
Revision History.....	18

Product Nomenclature

The product name is designated as below:

ELSWF – ABCDE – FGHIJ – V1234

Designation:

AB = min. luminous flux (lm) or radiation power (mW) performance

C = radiation pattern [1]

D = color [2]

E = power consumption [3]

F = reserved for future product offerings

G = Internal code

H = packaging type [4]

IJ = internal code

V = forward voltage bin

1234 = color bin or CCT bin

Notes

1. Table of radiation patterns

Symbol	Description
1	Lambertian

2. Table of color offerings:

Symbol	Color	Dominant wavelength range
L	Royal-Blue	445~460nm

3. Table of power consumptions:

Symbol	Description
2	2W

4. Table of packaging types:

Symbol	Description
P	Tape

Absolute Maximum Ratings

Parameter	Symbol	Ratings	Unit
Max. DC Forward Current (mA)	I_F	1000 ^[1]	mA
Max. Peak Pulse Current (mA)	I_{Pulse}	1250 ^[2]	mA
Max. ESD Resistance	V_B	8000	V
Reverse Voltage	V_R	Note 3	V
Thermal Resistance	R_{th}	10 ~ 12 ^[4]	°C/W
Max. Junction Temperature	T_J	125 ^[5]	°C
Operating Temperature	T_{Opr}	-40 ~ +100 ^[6]	°C
Storage Temperature	T_{Stg}	-40 ~ +100	°C
Max. Soldering Temperature	T_{Sol}	260	°C
Max. Allowable Reflow Cycles	n/a	2	cycles

Notes:

1. Duty cycle = 1/10@1KHZ
2. The Shwo series LEDs are not designed for reverse bias use.
3. Thermal Resistance is 10°C/W for Blue, Green, LEDs and 12°C/W for Red, LEDs.
4. Maximum junction temperature of Blue, Green, Red, LEDs is 125°C.

JEDEC Moisture Sensitivity

Level	Floor Life		Soak Requirements Standard	
	Time (hours)	Conditions	Time (hours)	Conditions
1	Unlimited	≤30°C / 85% RH	168 (+5/-0)	85°C / 85% RH

Luminous Flux Characteristics for the Shwo series

Color	Part Number	2W	
		Minimum Radiant Flux (mW) ^[1]	Drive Current (mA)
Royal Blue	ELSWF – S41LX	1300	700

Notes:

1. Luminous flux measurement tolerance: ±10%.
2. The data of luminous flux measured at thermal pad=25°C
3. Typical luminous flux or light output performance is operated within the condition guided by this datasheet.

PN of the Shwo(F) series: Color LEDs

The table below is a list of the binning options for the Everlight Shwo(F) 2W series Color LED.

Standard Everlight color bins are listed according to wavelength and represent the standard primary colors of the spectrum. Typical view angle is 120°. These clearly listed binning options allow for proper design and implementation into lighting applications. The Order Codes below are currently available Color Shwo(F) LEDs. For Example: If you order product using P/N **ELSWF-S41L2-6FPNM-DB4B6**, you will be specifying:

Color	Order Code of ELSWF	Minimum Radiant Flux (mW)	Typ. Radiometric Power (mW)	Peak Wavelength (nm)	PPF (umole/s)	PPE (umole/J)	Typ. Forward Voltage(V)
		700mA					
Royal Blue	ELSWF-S41L2-6FPN M-DB4B6	1300	1500	445~460	5.28	2.51	3.25

Product Binning

Radiant Flux Bins

Group	Bin	Minimum Radiant Flux (mW)	Maximum Radiant Flux (mW)
S	4	1300	1400
	5	1400	1500
	6	1500	1600
	7	1600	1700
	8	1700	1800

Forward Voltage Bins

Group Name	Bins
D	U4+V1+V2+V3

Group Name	Bin	Minimum Forward Voltage (V)	Maximum Forward Voltage (V)
D	U4	2.65	2.95
	V1	2.95	3.25
	V2	3.25	3.55
	V3	3.55	3.85

Notes:

1. Forward voltage measurement tolerance: $\pm 0.1V$.
2. Forward voltage bins are defined at $I_F=700mA$ operation.

Color Bins

Group	Bin	Minimum Dominant	Maximum Dominant
		Wavelength (nm)	Wavelength (nm)
Royal Blue	4	445	450
	5	450	455
	6	455	460

Notes:

1. Dominant / Peak wavelength measurement tolerance: $\pm 1nm$.
2. Dominant / Peak wavelength bins are defined at $I_F=1000mA$ operation.

Optical Characteristics

Color	Part Number	Wavelength (nm) λ_P			Typical Temperature Coefficient of Peak Wavelength (nm/°C)- $(\Delta\lambda_D/\Delta T_J)$	Typical Viewing Angle (degrees) $2\theta_{1/2}$
		Min.	Typ.	Max.		
Royal Blue	ELSWF – XX1LX	445	450~455	460	0.05	120

Notes:

1. The test tolerance of Everlight is $\pm 0.5nm$ for dominant wavelength,.
2. Viewing angle is the width of half the light output intensity in all directions of 180° .

Mechanical Dimension

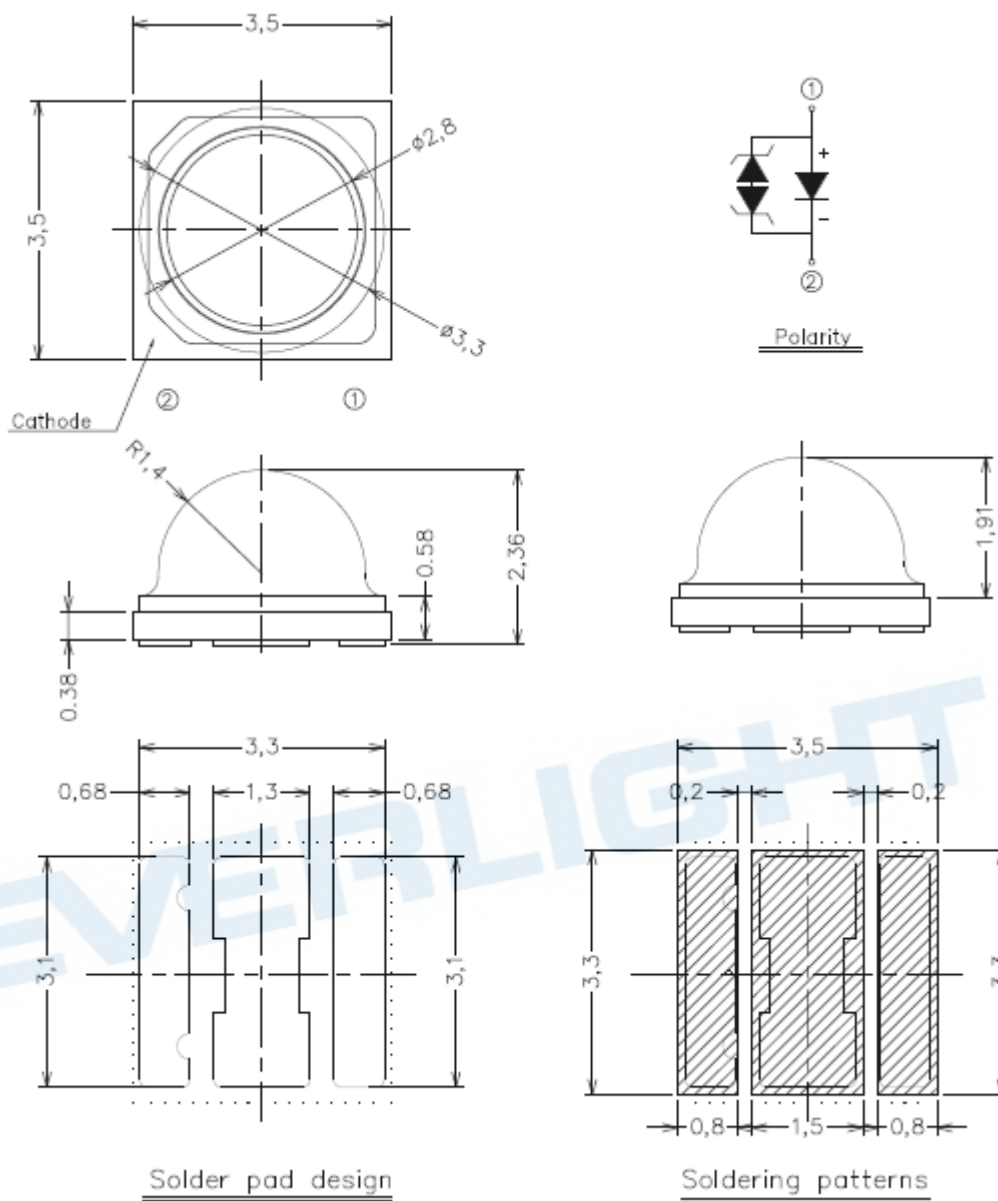

Notes:

1. Dimensions are in millimeters.
2. Tolerances unless mentioned are ± 0.15 mm.
3. The thermal pad is electrically isolated from the Anode and Cathode contact pads.
4. Do not handle the device by the lens. Incorrect force applied to the lens may lead to the failure of devices.

Pad Configuration

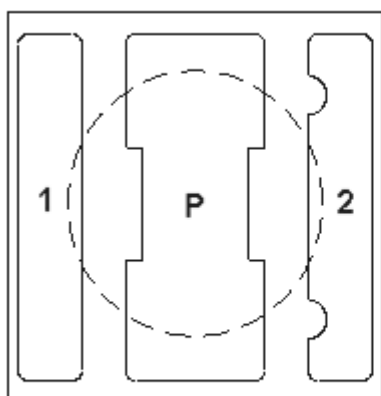

BOTTOM VIEW

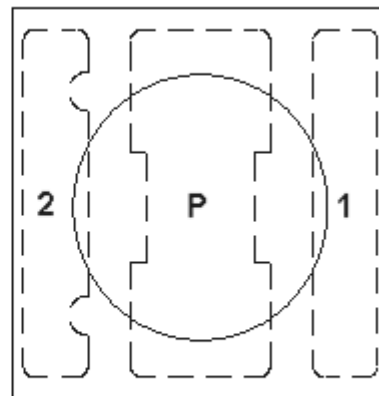

TOP VIEW

PAD	FUNCTION
1	ANODE
2	CATHODE
P	THERMAL PAD

Reflow Soldering Characteristics

For Reflow Process

- ELSWF series are suitable for SMT processes.
- Curing of glue in oven must be according to standard operation flow processes.

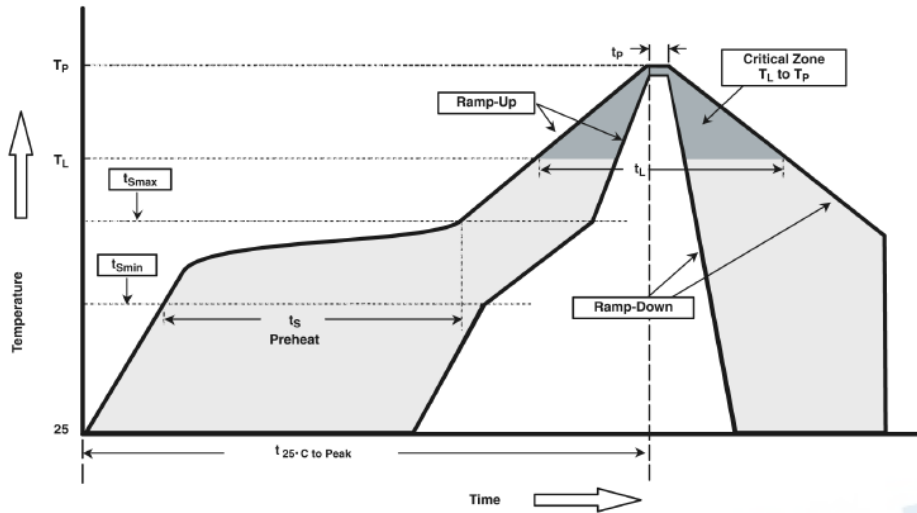

Profile Feature	Pb-Free Assembly	Unit Einheit
Average Ramp-up Rate 25 °C to 150 °C	2-3	°C /sec
Preheat Temperature Min.	150	sec
Preheat Temperature Max.	200	sec
Preheat Time	60-120	sec
Time Maintained Above Temperature	217	°C
Time Maintained Above Time	60-90	sec
Peak Temperature (max.)	260	°C
Time within 5°C of Actual Peak temperature	20-40	sec
Ramp-down Rate (max.)	3-5	°C /sec

- Reflow soldering should not be done more than twice.
- In soldering process, stress on the LEDs during heating should be avoided.
- After soldering, do not bend the circuit board.

Wavelength Characteristics

For Royal Blue @ Thermal Pad Temperature = 25°C

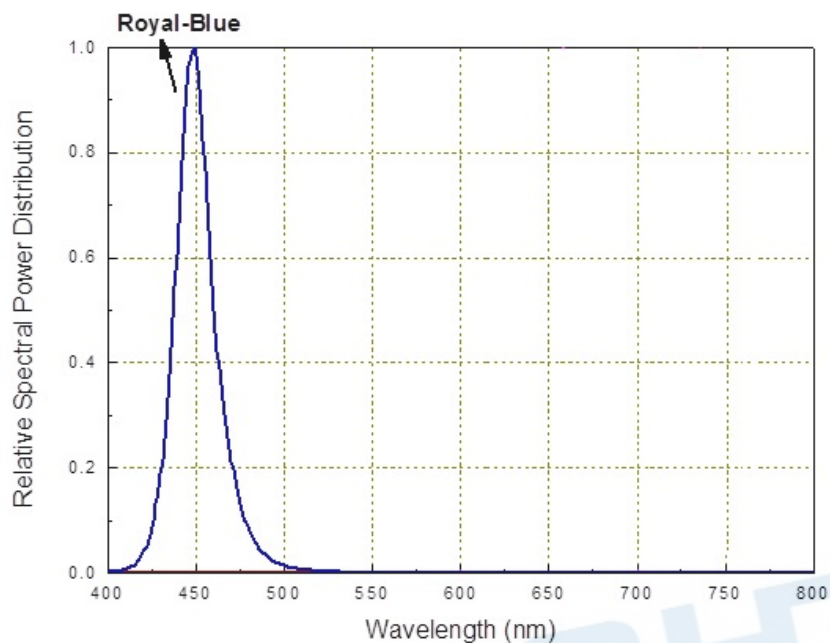

Typical Light Output Characteristic V.S. Thermal Pad Temperature

Royal Blue for 700mA Drive Current

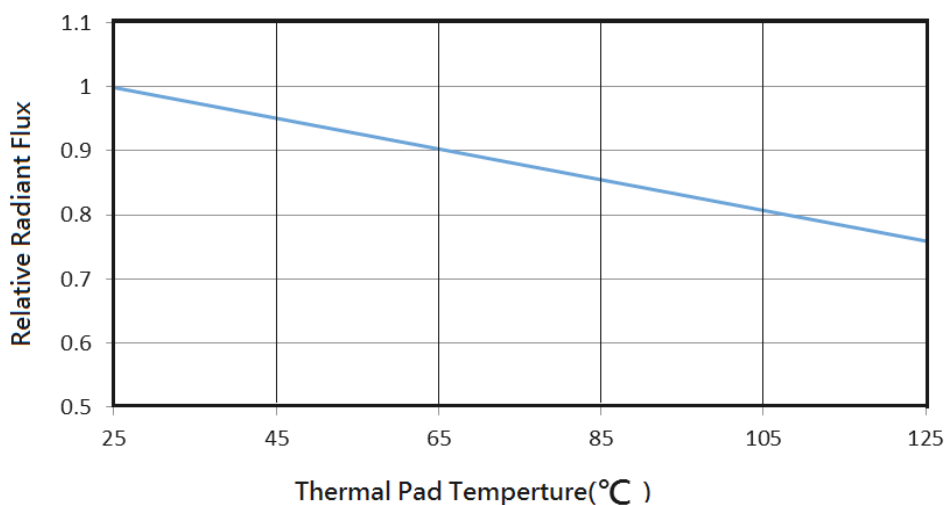

Typical Electrical Characteristics

For Royal Blue @ Thermal Pad Temperature = 25°C

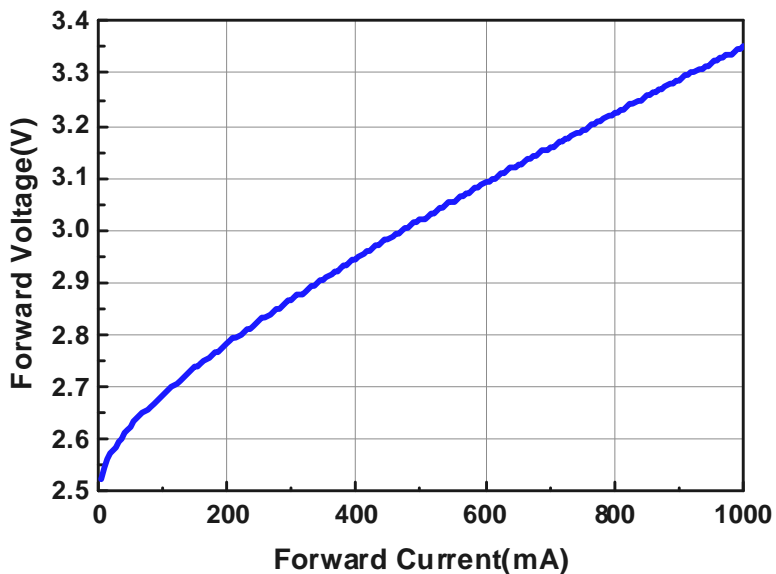

Typical Relative Radiant Flux V.S. Forward Current

For Royal Blue, @ Thermal Pad Temperature = 25°C

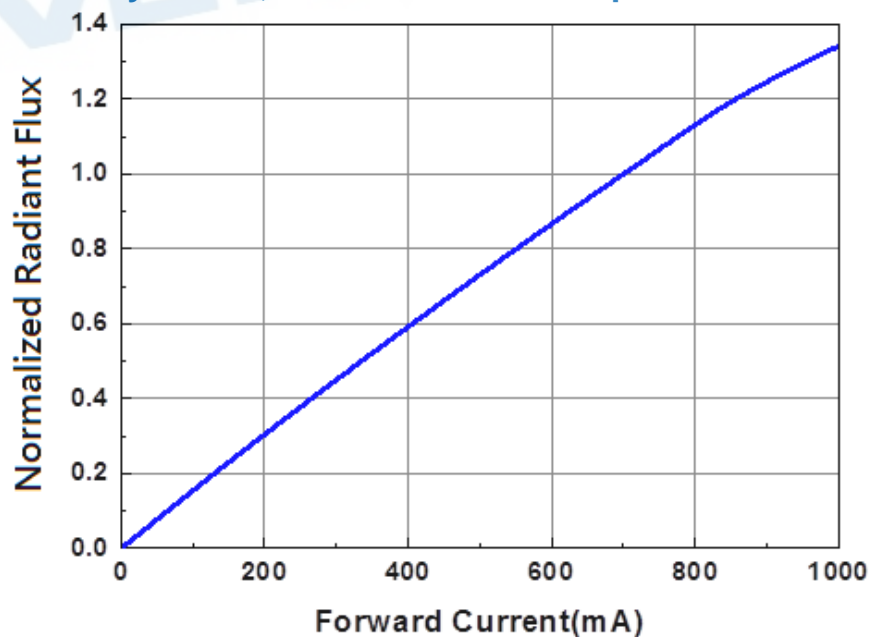

Typical Wavelength & Forward Current

For Royal Blue @ Thermal Pad Temperature = 25°C

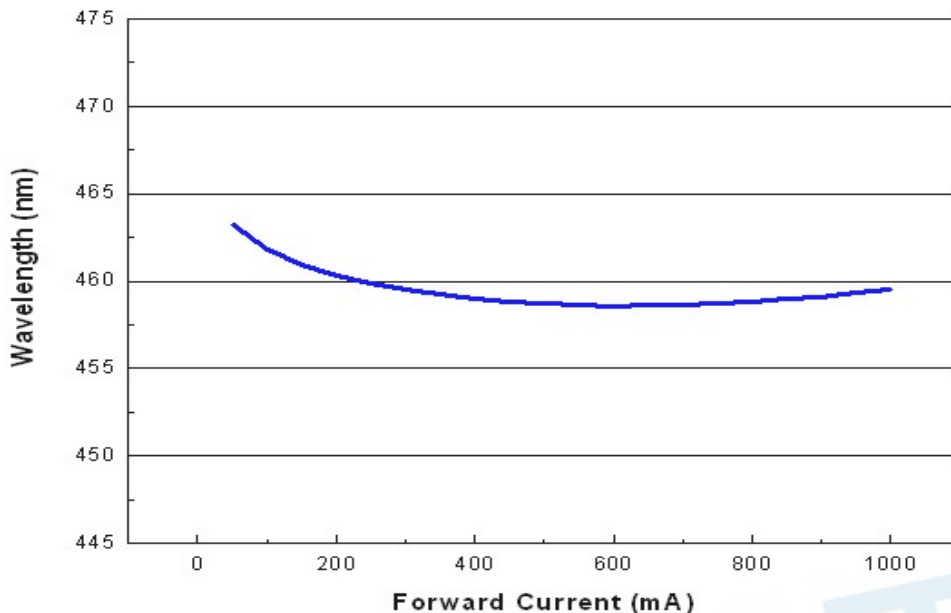

Current Derating Curves

Current Derating Curve for 1000mA Drive Current
 Royal-Blue

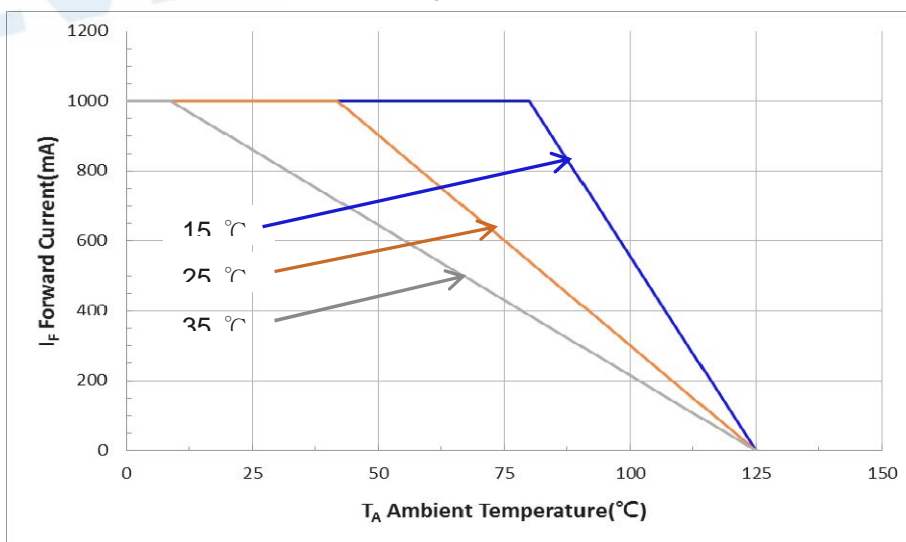

Note:

The current derating curves are depending on the thermal resistance between the junction to the soldering pad.

Typical Radiation Patterns

Shwo series: Typical Diagram Characteristics of Radiation

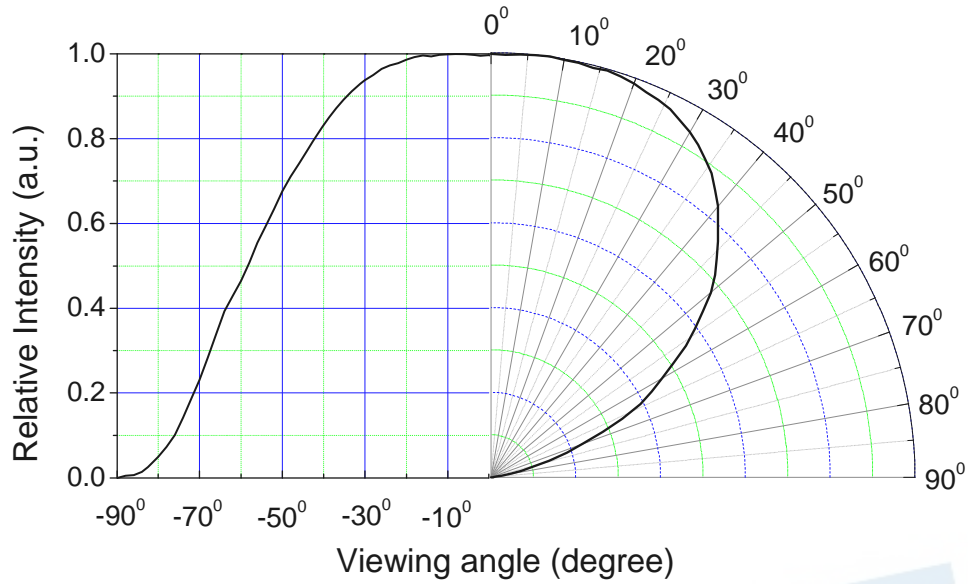

Notes:

1. $2\theta_{1/2}$ is the off axis angle from lamp centerline where the luminous intensity is 1/2 of the peak value.
2. View angle tolerance is $\pm 5^\circ$.

Emitter Tape Packaging

Carrier Tape Dimensions as the following:

Reel: 400pcs, MOQ_≥ 2Kpcs(has to be a multiple of 800pcs)

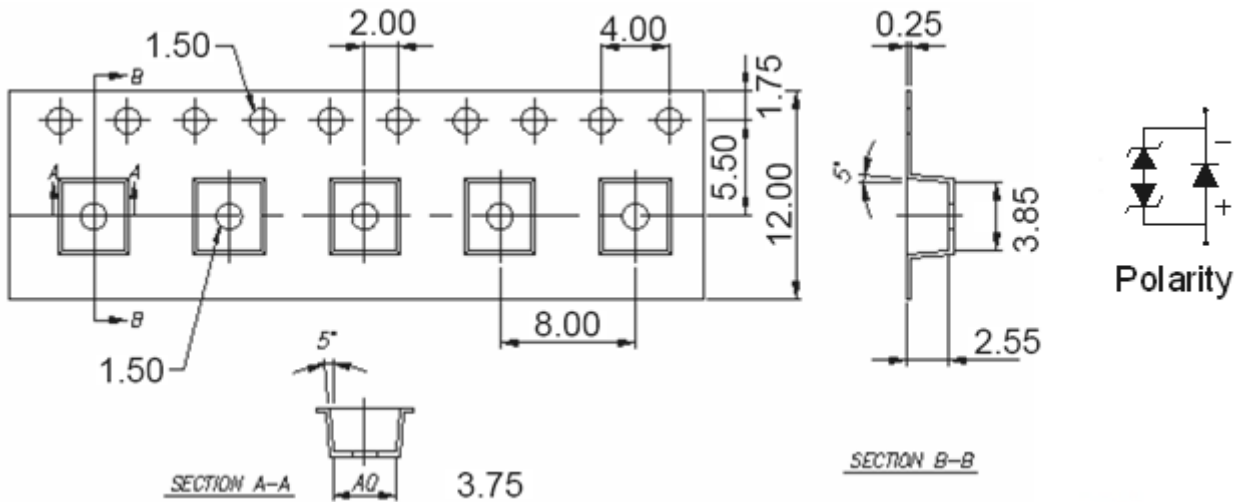

Notes:

1. Dimensions are in millimeters.
2. Tolerances for fixed dimensions are $\pm 0.1\text{mm}$.

Moisture Resistant Packaging

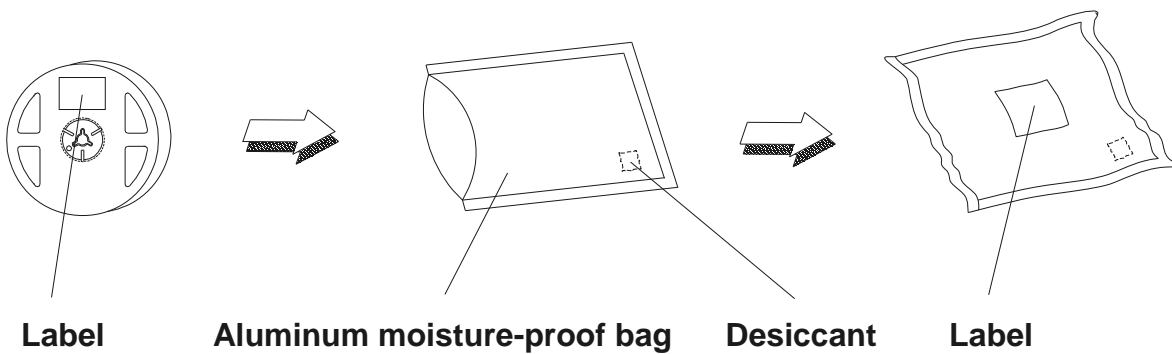

Emitter Reel Packaging

Reel Dimensions

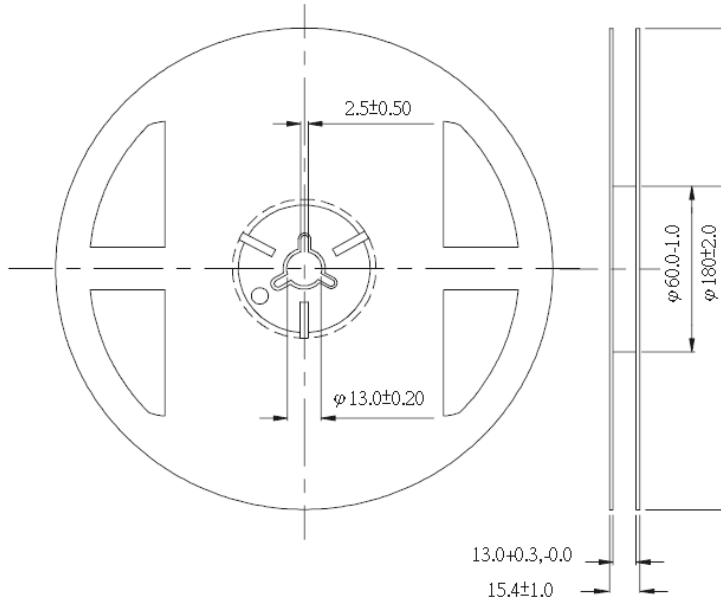

Notes:

1. Dimensions are in millimeters.
2. Tolerances unless mentioned are ± 0.1 mm.

Product Labeling

Label Explanation

CPN: Customer Specification (when required)

P/N : Everlight Production Number

QTY: Packing Quantity

CAT: Luminous Flux (Brightness) Bin

HUE: Color Bin

REF: Forward Voltage Bin

LOT No: Lot Number

MADE IN TAIWAN: Production Place

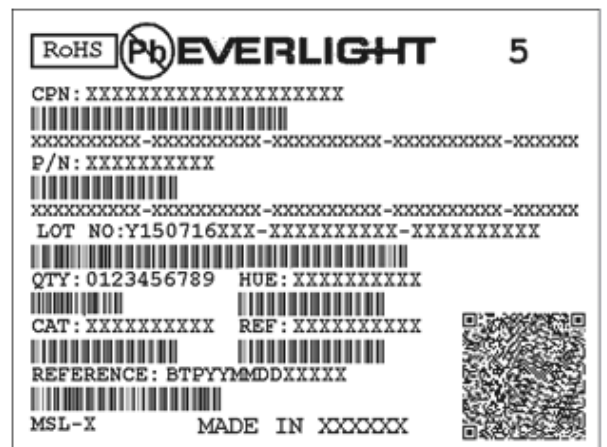

Storage Conditions

- Before the package is opened. The LEDs should be stored at 30°C or less and 85%RH or less after being shipped from Everlight and the storage life limits are 1 year. The LEDs can be stored up to 3 years If in a sealed container with a nitrogen atmosphere and moisture absorbent material.
- After opening the package: The LED's floor life is 1 year under 30°C or less and 60%RH or less. The LED should be soldered with 168hrs (7days) after opening the package. If unused LEDs remain, it should be stored in moisture proof packages.
- If the moisture absorbent material (silica gel) has faded away or the LEDs have exceeded the storage time, baking treatment should be performed using the following conditions. Baking treatment: 60±5°C for 24 hours.

EVERLIGHT

DISCLAIMER

1. EVERLIGHT reserves the right(s) on the adjustment of product material mix for the specification.
2. The product meets EVERLIGHT published specification for a period of twelve (12) months from date of shipment.
3. The graphs shown in this datasheet are representing typical data only and do not show guaranteed values.
4. When using this product, please observe the absolute maximum ratings and the instructions for using outlined in these specification sheets. EVERLIGHT assumes no responsibility for any damage resulting from the use of the product which does not comply with the absolute maximum ratings and the instructions included in these specification sheets.
5. These specification sheets include materials protected under copyright of EVERLIGHT. Reproduction in any form is prohibited without obtaining EVERLIGHT's prior consent.
6. This product is not intended to be used for military,aircraft,automotive,medical.

EVERLIGHT

Revision History

Current version: 2019/06/21
Device No : DHE-0003622
Version. 1.0

Page	Subjects (major change in previous version)	Date of change

EVERLIGHT