

SMD ■ MID POWER LED

EAHE5630WGx3



Features

- PLCC-2 Package
- Top view white LED
- High luminous flux output
- High current capability
- High Efficiency
- Wide viewing angle
- Pb-free
- RoHS compliant
- ANSI Binning

Description

The Everlight EAHE5630WGx3 package has high efficacy, high CRI, low power consumption, wide viewing angle and a compact form factor. These features make this package an ideal LED for all lighting application.

Applications

- Decorative and Entertainment Lighting
- Light pipe application
- Indicator and backlight in office and family equipment
- General use

Mass Production List for CRI>80

Product	CRI Min. (1)	CCT(K)	Φ(lm) Min. (2)	Φ(lm) Max. (2)
EAHE5630WG03	80	2700K	32	42
EAHE5630WG13	80	3000K	33	43
EAHE5630WG23	80	3500K	33	43
EAHE5630WG33	80	4000K	35	45
EAHE5630WG43	80	5000K	36	46
EAHE5630WG53	80	5700K	36	46
EAHE5630WG63	80	6500K	35	45

Note:

1. Tolerance of Color Rendering Index: ± 2
2. Tolerance of Luminous flux: $\pm 11\%$.

Device Selection Guide

Chip Materials	Emitted Color	Resin Color
InGaN	Cool White	Water Clear
	Neutral White	
	Warm White	

Absolute Maximum Ratings (T_{Soldering}=25)

Parameter	Symbol	Rating	Unit
Forward Current	I _F	180	mA
Peak Forward Current (Duty 1/10 @10ms)	I _{FP}	300	mA
Power Dissipation	P _d	540	mW
Operating Temperature	T _{opr}	-40 ~ +85	
Storage Temperature	T _{stg}	-40 ~ +100	
Thermal Resistance (Junction / Soldering point)	R _{th J-S}	21	/W
Junction Temperature	T _j	115	
Soldering Temperature	T _{sol}	Reflow Soldering : 260 Hand Soldering : 350	for 10 sec. for 3 sec.

Electro-Optical Characteristics (T_{Soldering}=25)

Parameter	Symbol	Min.	Typ.	Max.	Unit	Condition
Luminous Flux ₍₁₎	Φ	32	-----	46	lm	I _F =65mA
Forward Voltage ₍₂₎	V _F	2.5	-----	3.0	V	I _F =65mA
Color Rendering Index ₍₃₎	Ra	80	-----	-----	-----	I _F =65mA
Viewing Angle	2θ _{1/2}	-----	120	-----	deg	I _F =65mA

Notes:

1. Tolerance of Luminous flux: ±11%.
2. Tolerance of Forward Voltage: ±0.1V.
3. Tolerance of Color Rendering Index: ±2

Bin Range of Luminous Flux

2700K----EAHE5630WG03

Bin Code	Min.	Max.	Unit	Condition
T1	32	34	lm	I _F =65mA
T2	34	36		
T3	36	38		
T4	38	40		
T5	40	42		

3000K----EAHE5630WG13

Bin Code	Min.	Max.	Unit	Condition
T1	33	35	lm	I _F =65mA
T2	35	37		
T3	37	39		
T4	39	41		
T5	41	43		

3500K----EAHE5630WG23

Bin Code	Min.	Max.	Unit	Condition
T1	33	35	lm	I _F =65mA
T2	35	37		
T3	37	39		
T4	39	41		
T5	41	43		

4000K----EAHE5630WG33

Bin Code	Min.	Max.	Unit	Condition
T1	35	37	lm	I _F =65mA
T2	37	39		
T3	39	41		
T4	41	43		
T5	43	45		

5000K----EAHE5630WG43

Bin Code	Min.	Max.	Unit	Condition
T1	36	38	lm	I _F =65mA
T2	38	40		
T3	40	42		
T4	42	44		
T5	44	46		

5700K----EAHE5630WG53

Bin Code	Min.	Max.	Unit	Condition
T1	36	38	lm	I _F =65mA
T2	38	40		
T3	40	42		
T4	42	44		
T5	44	46		

6500K----EAHE5630WG63

Bin Code	Min.	Max.	Unit	Condition
T1	35	37	lm	I _F =65mA
T2	37	39		
T3	39	41		
T4	41	43		
T5	43	45		

Notes:
Tolerance of Luminous flux: ±11%

Bin Range of Forward Voltage

Group	Bin Code	Min.	Max.	Unit	Condition
2530	32	2.5	2.6	V	I _F =65mA
	33	2.6	2.7		
	34	2.7	2.8		
	35	2.8	2.9		
	36	2.9	3.0		

Notes:
Tolerance of Forward Voltage : ±0.1V.

Bin Code of Macadam 3 step

Step	CCT	Cx	Cy	a	b	theta
3	2700	0.4583	0.4104	0.00810	0.00420	49.70
	3000	0.4345	0.4033	0.00834	0.00408	50.22
	3500	0.4080	0.3919	0.00927	0.00414	51.00
	4000	0.3827	0.3803	0.00939	0.00402	54.80
	5000	0.3451	0.3559	0.00822	0.00354	64.12
	5700	0.3293	0.3423	0.00747	0.00321	66.51
	6500	0.3131	0.3290	0.00669	0.00285	64.57

The C.I.E. 1931 Chromaticity Diagram

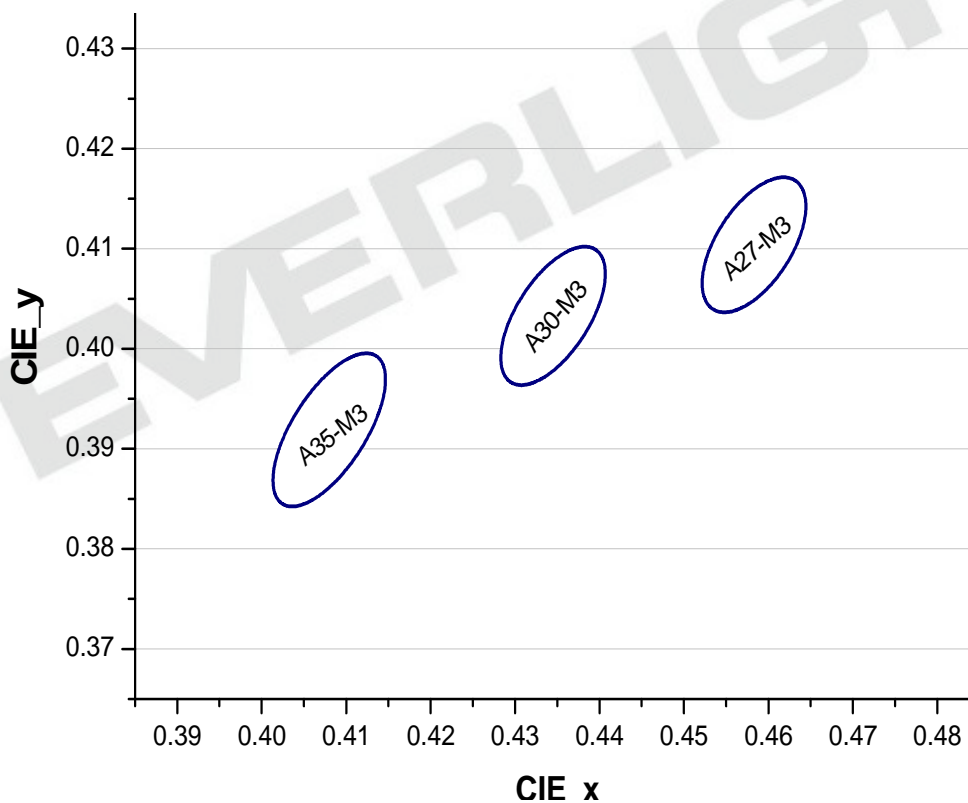

The C.I.E. 1931 Chromaticity Diagram

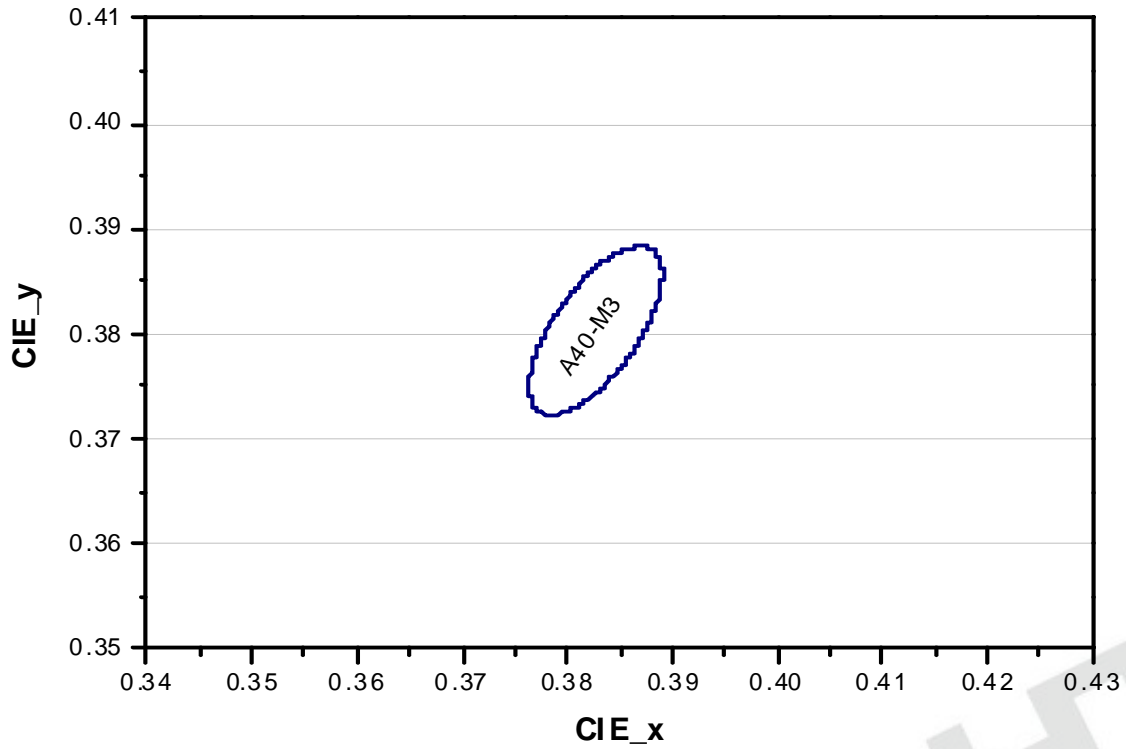

The C.I.E. 1931 Chromaticity Diagram

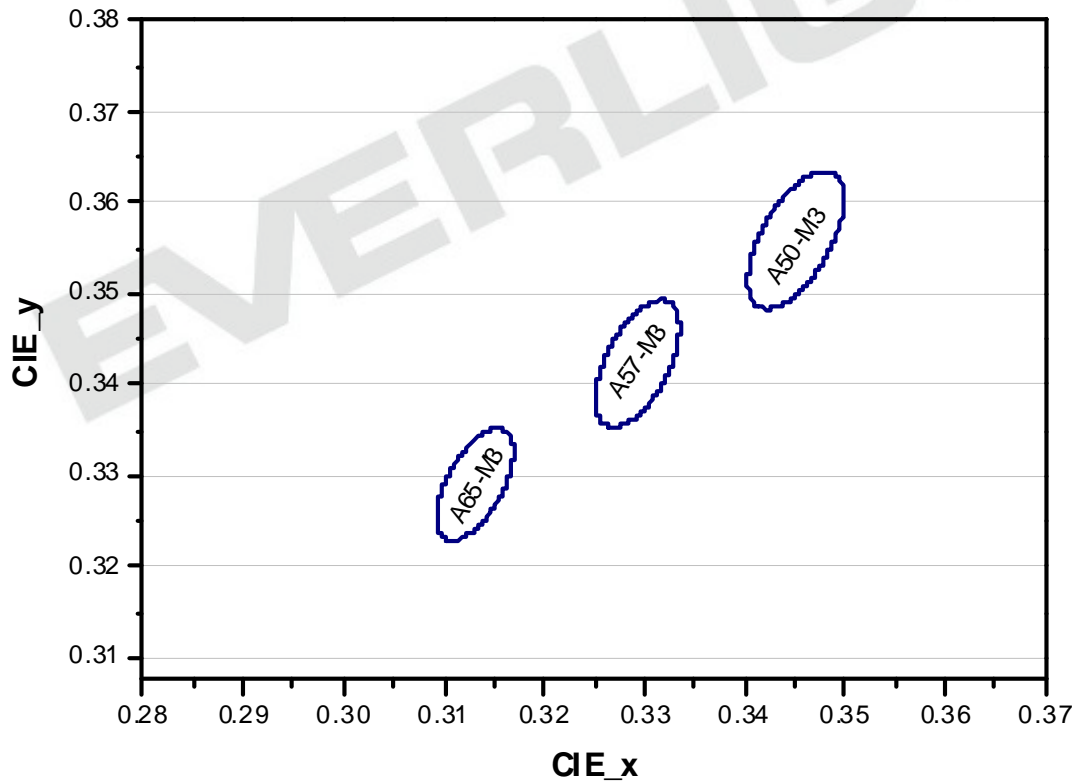

Notes:

1. The value is based on driving current by 65mA.
2. Tolerance of Chromaticity Coordinates: ± 0.01 .

Spectrum Distribution

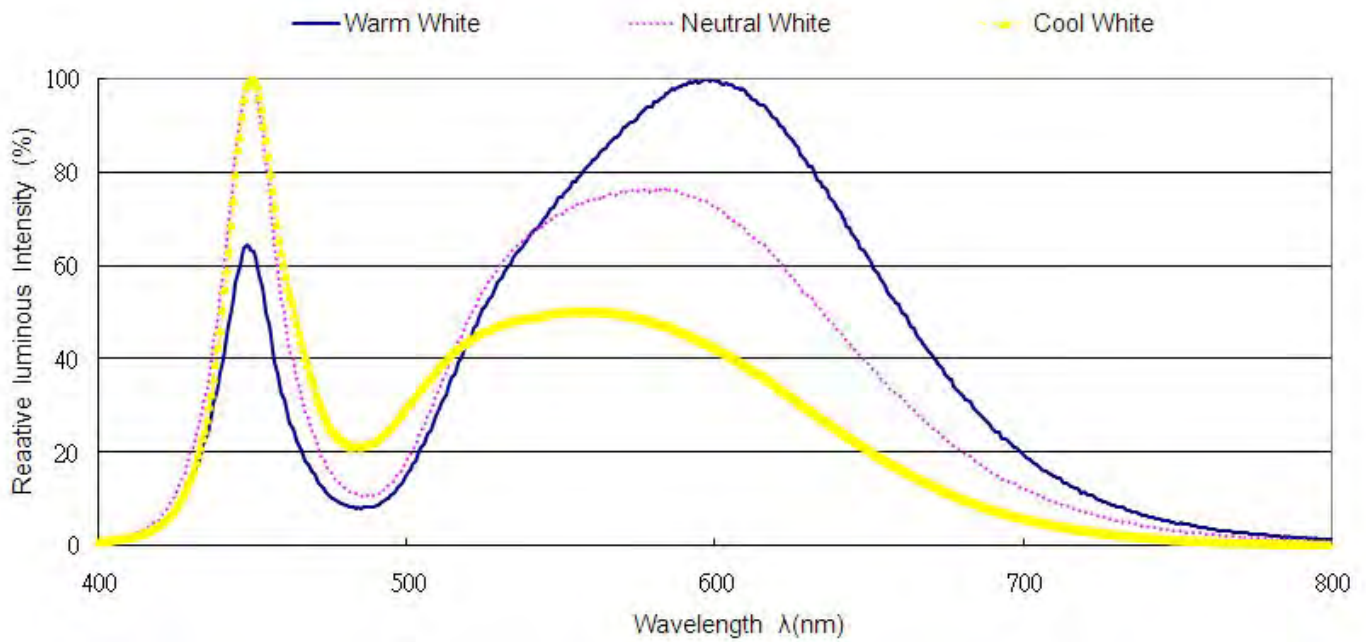

Typical Electro-Optical Characteristics Curves

Fig.1 – Forward Voltage Shift vs. Junction Temperature

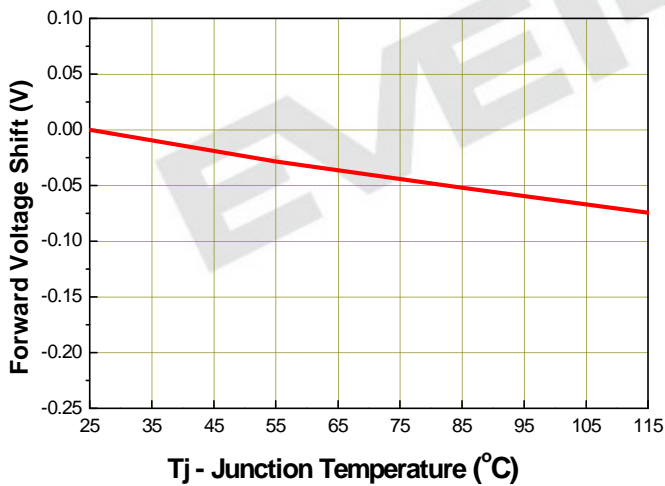
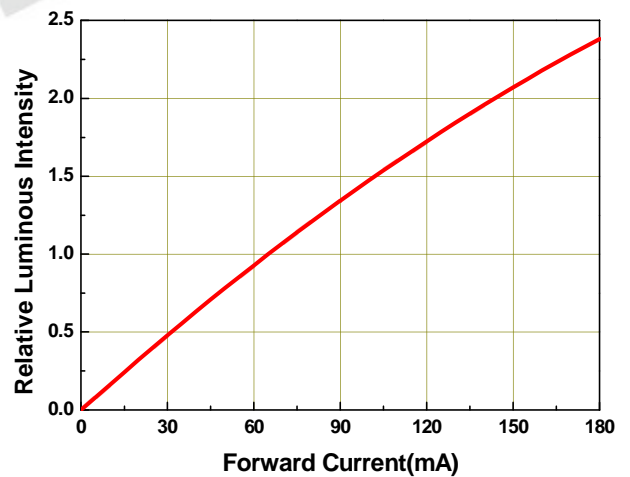

Fig.2 - Relative Luminous Intensity vs. Forward Current



Typical Electro-Optical Characteristics Curves

Fig.3 - Relative Luminous Intensity vs. Junction Temperature

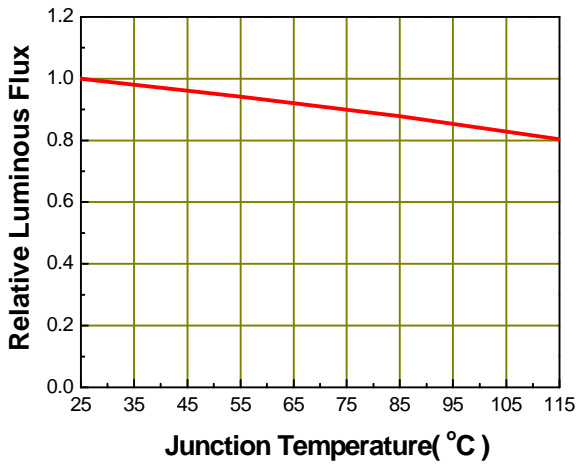

Fig.4 - Forward Current vs. Forward Voltage

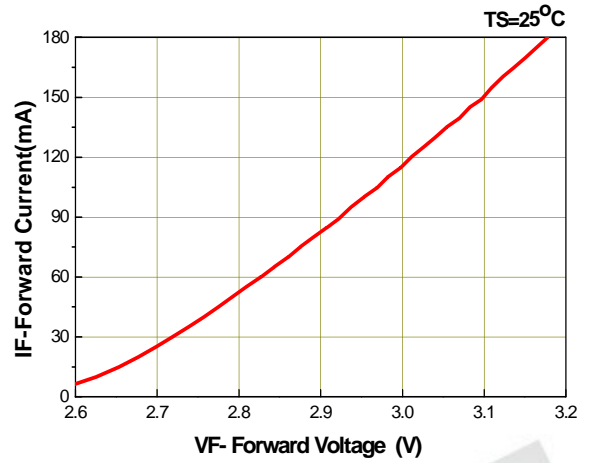

Fig.5 – Max. Driving Forward Current vs. Soldering Temperature

$R_{th\ j-s}=21^{\circ}\ C/W$

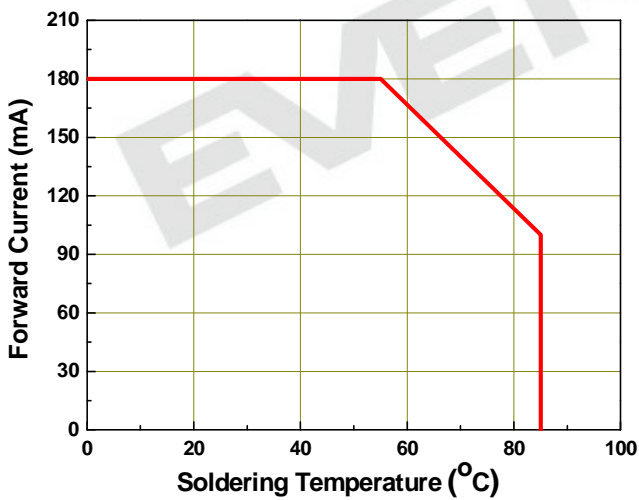
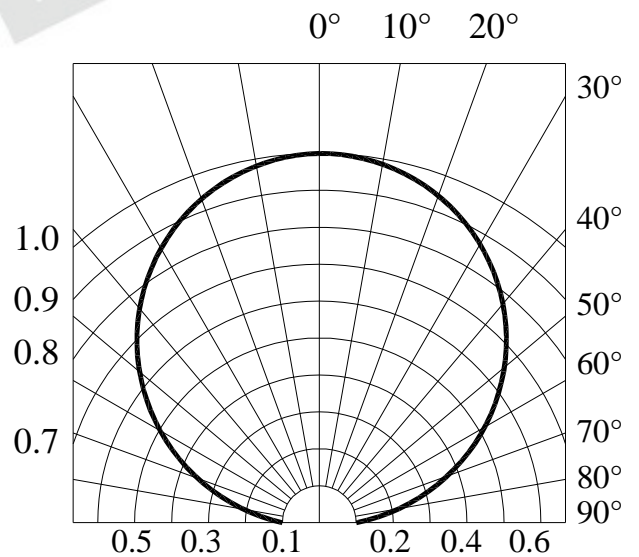
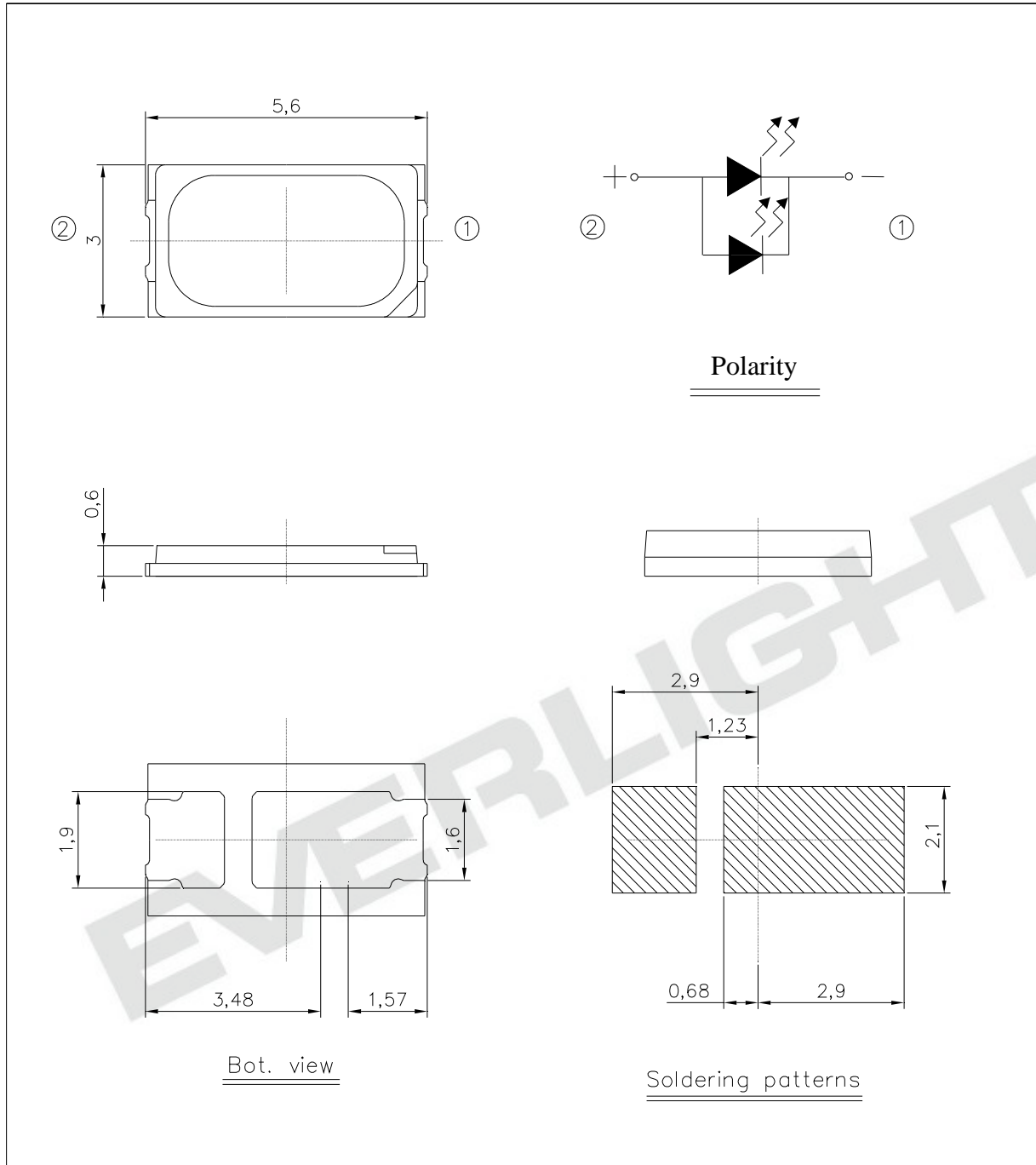

Fig.6 – Radiation Diagram



Package Dimension



Note:

Tolerance unless mentioned is $\pm 0.1\text{mm}$; Unit = mm

Moisture Resistant Packing Materials

Label Explanation

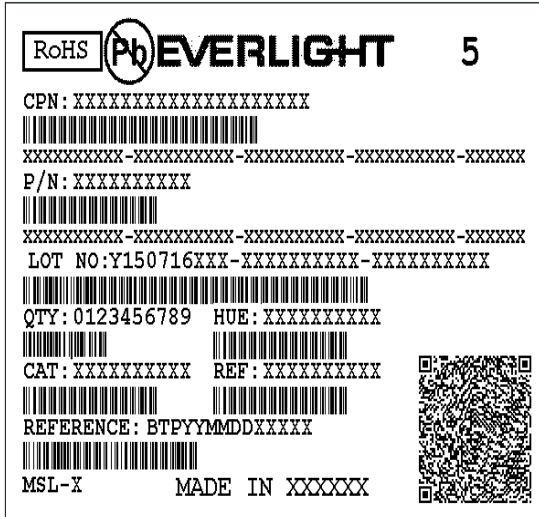

- CPN: Customer's Product Number
- P/N: Product Number
- QTY: Packing Quantity
- CAT: Luminous Intensity Rank
- HUE: Dom. Wavelength Rank
- REF: Forward Voltage Rank
- LOT No: Lot Number

Reel Dimensions

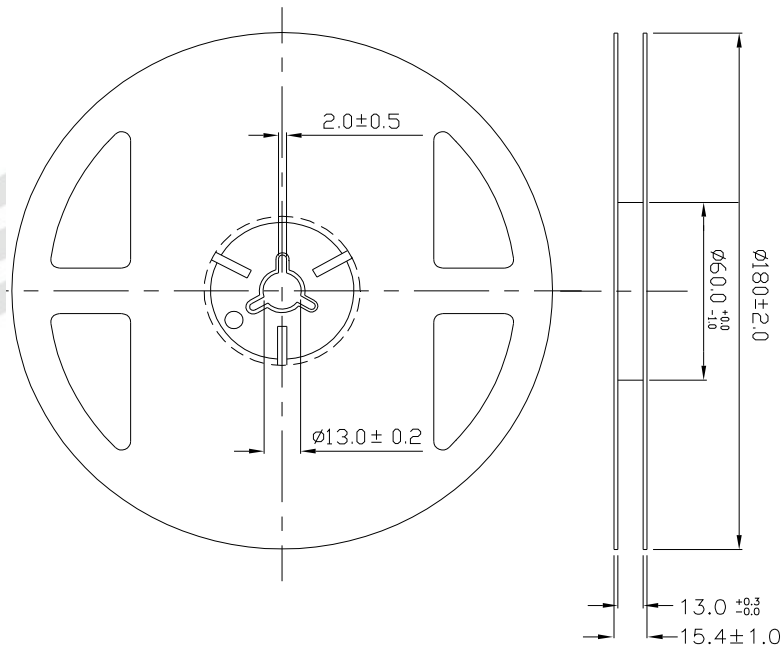

Note:
Tolerances unless mentioned ± 0.1 mm. Unit = mm

Carrier Tape Dimensions: Loaded Quantity 2000 pcs. Per Reel

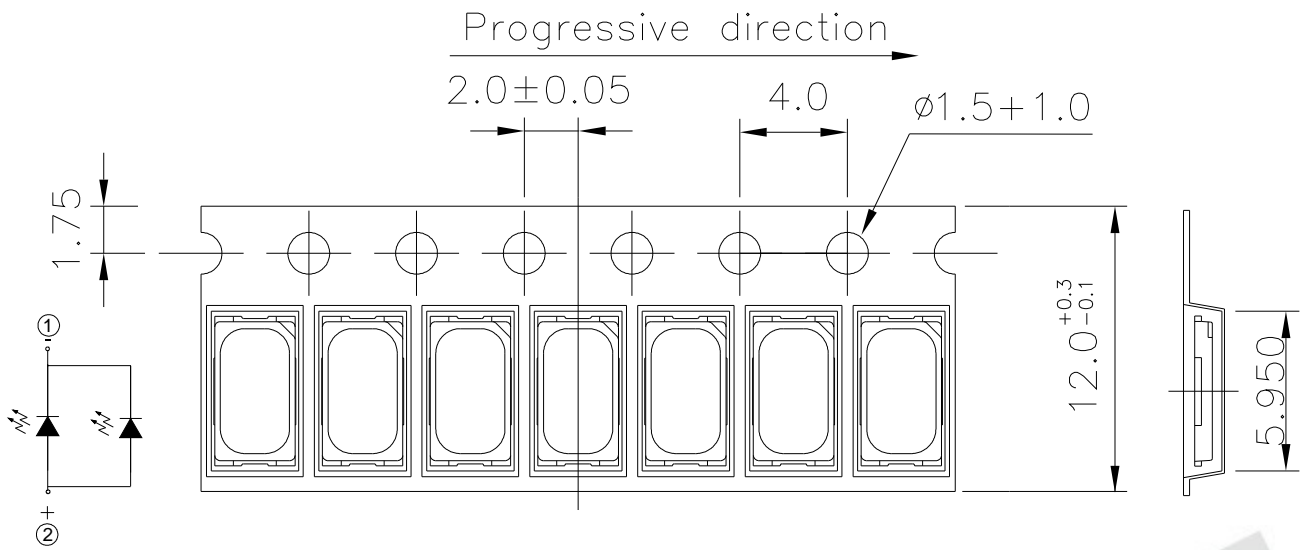

Polarity

Note:

Tolerance unless mentioned is ±0.1mm; Unit = mm

Moisture Resistant Packing Process

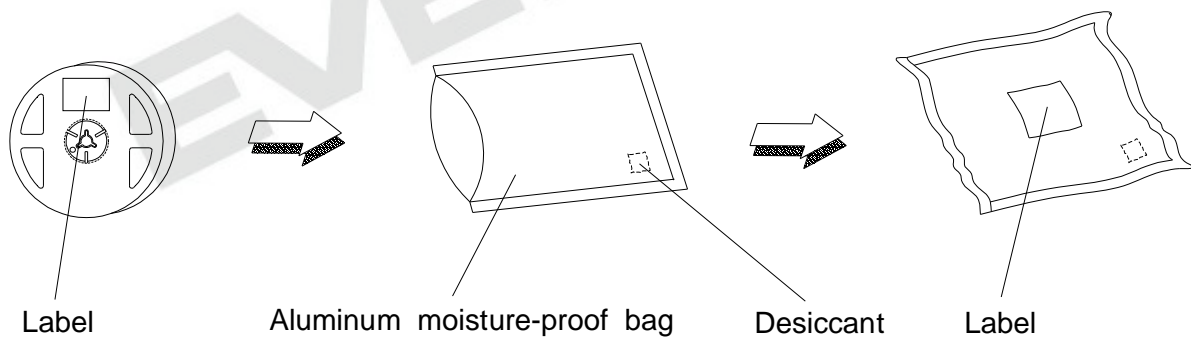

Reliability Test Items and Conditions

The reliability of products shall be satisfied with items listed below.
Confidence level : 90%
LTPD : 10%

No.	Items	Test Condition	Test Hours/Cycles	Sample Size	Ac/Re
1	Reflow Soldering	Temp. : 260 /10sec.	6 Min.	22 PCS.	0/1
2	Thermal Shock	H : +100 20min 10 sec L : -10 20min	200 Cycles	22 PCS.	0/1
3	Temperature Cycle	H : +100 30min 5 min L : -40 30min	200 Cycles	22 PCS.	0/1
4	High Temperature/Humidity Storage	Ta=85 ,85%RH	1000 Hrs.	22 PCS.	0/1
5	High Temperature/Humidity Operation	Ta=85 ,85%RH, I _F = 100 mA	1000 Hrs.	22 PCS.	0/1
6	Low Temperature Storage	Ta=-40	1000 Hrs.	22 PCS.	0/1
7	High Temperature Storage	Ta=85	1000 Hrs.	22 PCS.	0/1
8	Low Temperature Operation Life	Ta=-40 , I _F = 150 mA	1000 Hrs.	22 PCS.	0/1
9	High Temperature Operation/ Life#1	Ta=25 , I _F = 150 mA	1000 Hrs.	22 PCS.	0/1
10	High Temperature Operation/ Life#2	Ta=55 , I _F =150 mA	1000 Hrs.	22 PCS.	0/1
11	High Temperature Operation/ Life#3	Ta=85 , I _F = 100 mA	1000 Hrs.	22 PCS.	0/1

Precautions for Use

1. Over-current-proof

Customer must apply resistors for protection; otherwise slight voltage shift will cause big current change (Burn out will happen).

2. Storage

2.1 Do not open moisture proof bag before the products are ready to use.

2.2 Before opening the package: The LEDs should be kept at 30 °C or less and 90%RH or less.

2.3 After opening the package: The LED's floor life is 168 Hrs under 30 °C or less and 60% RH or less. If unused LEDs remain, it should be stored in moisture proof packages.

2.4 If the moisture absorbent material (silica gel) has faded away or the LEDs have exceeded the storage time, baking treatment should be performed using the following conditions.

Baking treatment: 60±5 °C for 24 hours.

3. Soldering Condition

3.1 Pb-free solder temperature profile

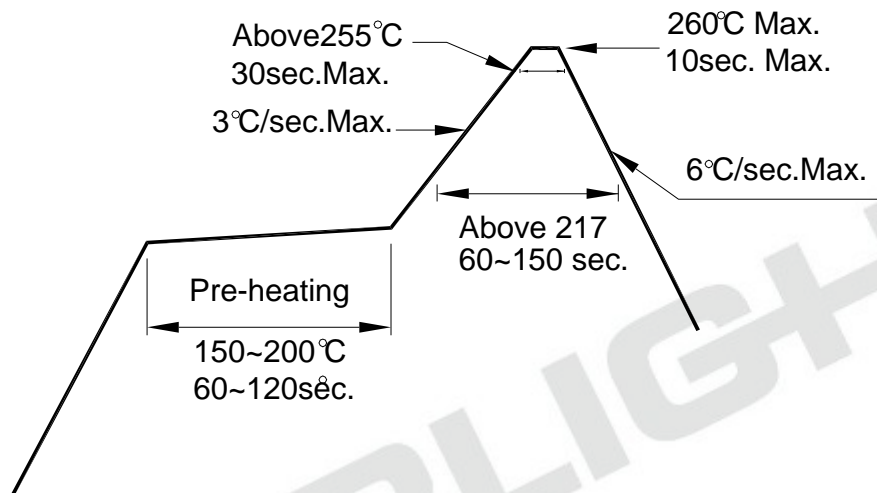

3.2 Reflow soldering should not be done more than two times.

3.3 When soldering, do not put stress on the LEDs during heating.

3.4 After soldering, do not warp the circuit board.

4. Soldering Iron

Each terminal is to go to the tip of soldering iron temperature less than 350 °C for 3 seconds within once in less than the soldering iron capacity 25W. Leave two seconds and more intervals, and do soldering of each terminal. Be careful because the damage of the product is often started at the time of the hand solder.

5. Repairing

Repair should not be done after the LEDs have been soldered. When repairing is unavoidable, a double-head soldering iron should be used (as below figure). It should be confirmed beforehand whether the characteristics of the LEDs will or will not be damaged by repairing.

