

### SMD EAST1410RGBW02

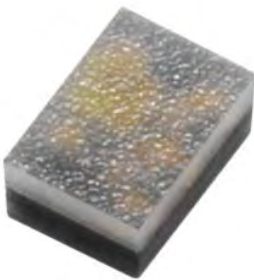

#### Features

- Package in 8mm tape on 7" diameter reel.
- Compatible with automatic placement equipment.
- Compatible with infrared and vapor phase reflow.
- Solder process.
- Full-color type.
- Pb-free.
- Component solderable surface finish is Gold.
- Component weight is 1.5 mg.
- The Product itself will remain within RoHS compliant version.
- Compliance with EU REACH.
- Compliance Halogen Free.(Br<900ppm,Cl<900ppm,B+Cl<1500ppm).

#### Description

- The EAST1410RGBW02 SMD LED is much smaller than lead frame type components, thus enables smaller board size, higher packing density, reduced storage space and finally smaller equipment to be obtained.
- Moreover, with its black PCB, the EAST1410RGBW02 possess an ideal solution for high-contrast and high-resolution indoor signage display.

#### Applications

- Indoor signage display applications.
- Indoor decorating and entertainment design.
- Flat backlight for LCD, switch and symbol.
- Indicator and backlighting for all consumer electronics.

## Device Selection Guide

Chip Materials	Emitted Color	Resin Color
AlGaInP	Brilliant Red	White Surface Diffused
InGaN	Brilliant Green	
InGaN	Brilliant Blue	
InGaN	Brilliant White	

## Absolute Maximum Ratings (Ta=25°C)

Parameter	Symbol	Rating	Unit
Forward Current	I <sub>F</sub>	R6:10 GA:10 BD:10 T8: 10	mA
Peak Forward Current (Duty 1/10 @1KHz)	I <sub>FP</sub>	R6:15 GA:15 BD:15 T8: 15	mA
Power Dissipation	P <sub>d</sub>	R6:19 GA:29 BD:29 T8:29	mW
Junction Temperature	T <sub>j</sub>	100	°C
Operating Temperature	T <sub>opr</sub>	-40 ~ +85	°C
Storage Temperature	T <sub>stg</sub>	-40 ~ +90	°C
ESD (Classification acc. AEC Q101)	ESD <sub>HBM</sub>	R:2000 G:150 B:150 W:150	V
Soldering Temperature	T <sub>sol</sub>	Reflow Soldering : 260 °C for 10 sec. Hand Soldering : 350 °C for 3 sec.	

### Electro-Optical Characteristics (Ta=25°C)

Parameter	Symbol	Min.	Typ.	Max.	Unit	Condition	
Luminous Intensity	Iv	R6	3	----	8.5	mcd	IF=1mA
		GA	25	----	63		
		BD	5	----	16		
		T8	10	----	30		
Viewing Angle	2θ <sub>1/2</sub>	-----	120	-----	deg	IF=1mA	
Dominant Wavelength Color Temp.	λd CT	R6	616	-----	628	nm K	IF=1mA
		GA	523	-----	538		
		BD	463	-----	478		
		T8	5000	-----	8000		
Forward Voltage	VF	R6	1.6	-----	1.9	V	IF=1mA
		GA	2.3	-----	2.5		
		BD	2.6	-----	2.8		
		T8	2.6	-----	2.8		
Reverse Current <sup>4</sup>	IR	-----	-----	10	nA	VR=9V	

Note:

1. Tolerance of Luminous Intensity: ±10%
2. Tolerance of Dominant Wavelength: ±1nm
3. Tolerance of Forward Voltage: ±0.1V
4. Only for Electronic test

### Floating Bin(R6) Bin Range of Luminous Intensity

Bin Code	Min.	Max.	Unit	Condition
RA	3.0	5.0	mcd	I <sub>F</sub> =1mA
RB	5.0	8.5		

### Bin Range of Dominant Wavelength

Bin Code	Min.	Max.	Unit	Condition
R1	616	628	nm	I <sub>F</sub> =1mA

### Bin Range of Dominant Voltage

Bin Code	Min.	Max.	Unit	Condition
R1	1.6	1.9	v	I <sub>F</sub> =1mA

Note:

- 1.Tolerance of Luminous Intensity: ±10%
- 2.Tolerance of Dominant Wavelength: ±1nm
3. Tolerance of Forward Voltage: ±0.1V

**Floating Bin(GA)**  
**Bin Range of Luminous Intensity**

Bin Code	Min.	Max.	Unit	Condition
GA	25.0	40.0	mcd	I <sub>F</sub> =1mA
GB	40.0	64.0		

**Bin Range of Dominant Wavelength**

Bin Code	Min.	Max.	Unit	Condition
G1	523	538	nm	I <sub>F</sub> =1mA

**Bin Range of Dominant Voltage**

Bin Code	Min.	Max.	Unit	Condition
G1	2.3	2.5	v	I <sub>F</sub> =1mA

Note:

1. Tolerance of Luminous Intensity: ±10%
2. Tolerance of Dominant Wavelength: ±1nm
3. Tolerance of Forward Voltage: ±0.1V

## Floating Bin(BD) Bin Range of Luminous Intensity

Bin Code	Min.	Max.	Unit	Condition
BA	5.0	9.0	mcd	$I_F = 1\text{mA}$
BB	9.0	16.0		

## Bin Range of CIE

Bin Code	X	Y.	Condition
B1	0.1384	0.0370	$I_F = 1\text{mA}$
	0.0959	0.1248	
	0.1257	0.1700	
	0.1672	0.0800	

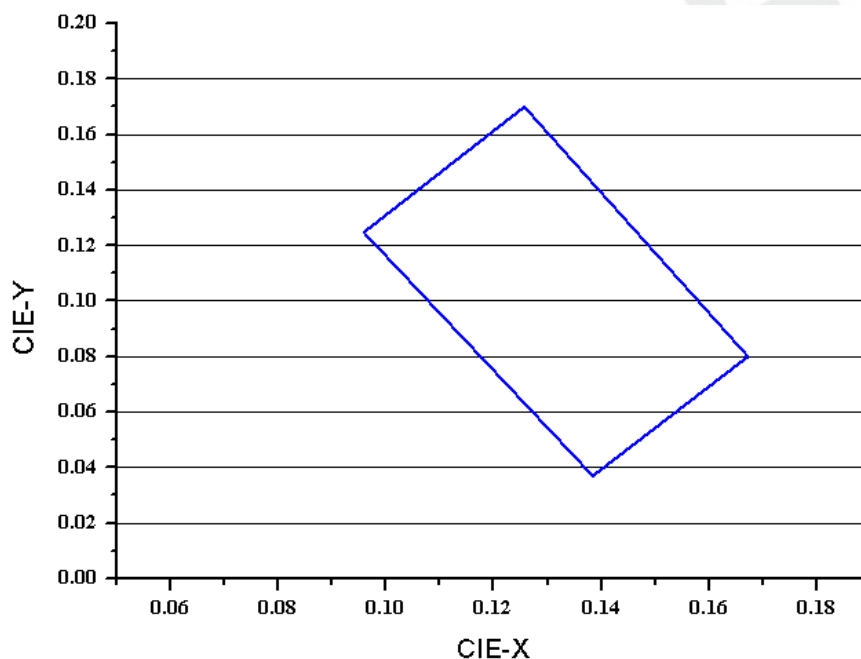

## Bin Range of Dominant Voltage

Bin Code	Min.	Max.	Unit	Condition
B1	2.6	2.8	v	$I_F = 1\text{mA}$

Note:

1. Tolerance of Luminous Intensity:  $\pm 10\%$
2. Tolerance of Color coordinates:  $\pm 0.01$
3. Tolerance of Forward Voltage:  $\pm 0.1\text{V}$

**Floating Bin(T8)  
Bin Range of Luminous Intensity**

Bin Code	Min.	Max.	Unit	Condition
TA	10.0	17.0	mcd	I <sub>F</sub> =1mA
TB	17.0	30.0		

**Bin Range of Dominant Voltage**

Bin Code	Min.	Max.	Unit	Condition
T1	2.6	2.8	v	I <sub>F</sub> =1mA

Note:

- 1.Tolerance of Luminous Intensity:  $\pm 10\%$
2. Tolerance of Forward Voltage:  $\pm 0.1V$

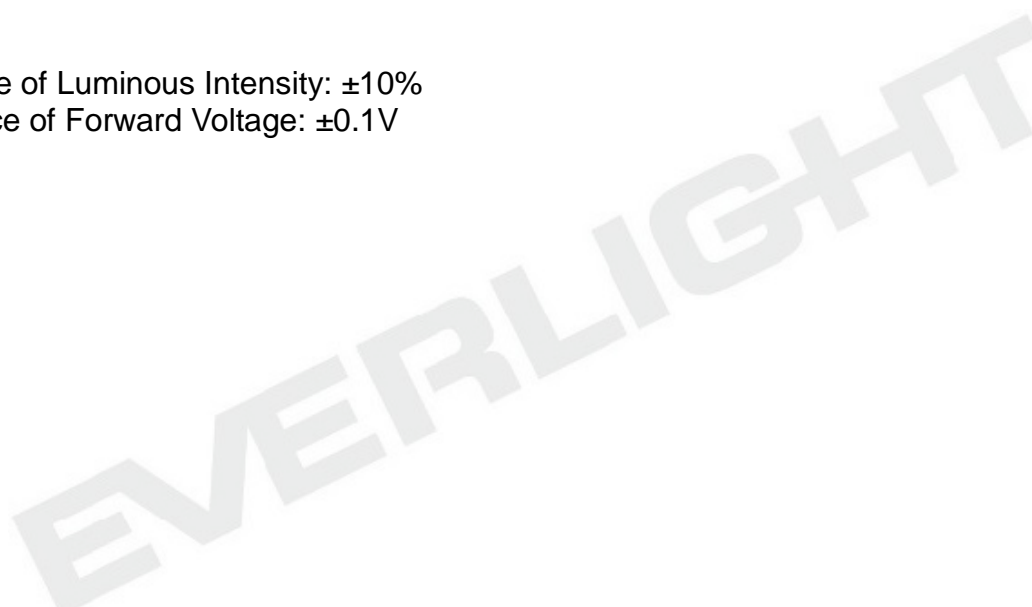

### Bin Range of CIE

Bin Code	X	Y.	Condition
W1	0.264	0.256	I <sub>F</sub> =1mA
	0.218	0.307	
	0.187	0.226	
	0.248	0.214	
W2	0.297	0.299	
	0.270	0.380	
	0.218	0.307	
	0.264	0.256	
W3	0.297	0.299	
	0.270	0.380	
	0.316	0.420	
	0.322	0.324	
W4	0.322	0.324	
	0.316	0.420	
	0.353	0.440	
	0.344	0.342	
W5	0.377	0.349	
	0.405	0.463	
	0.353	0.440	
	0.344	0.342	

Note:

1. Tolerance of Color coordinates:  $\pm 0.01$



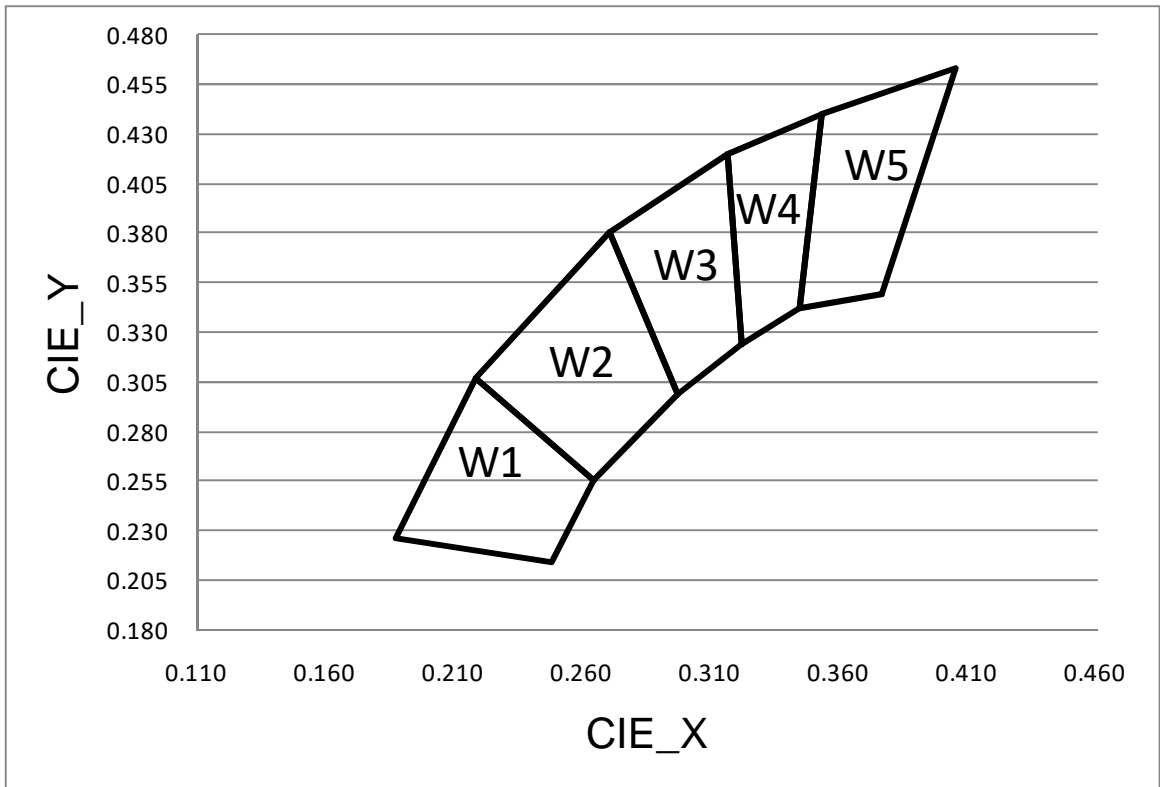

EVERLIGHT

## Typical Electro-Optical Characteristics Curves

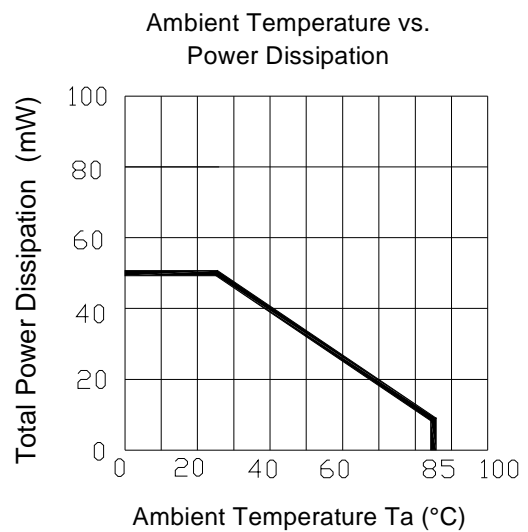
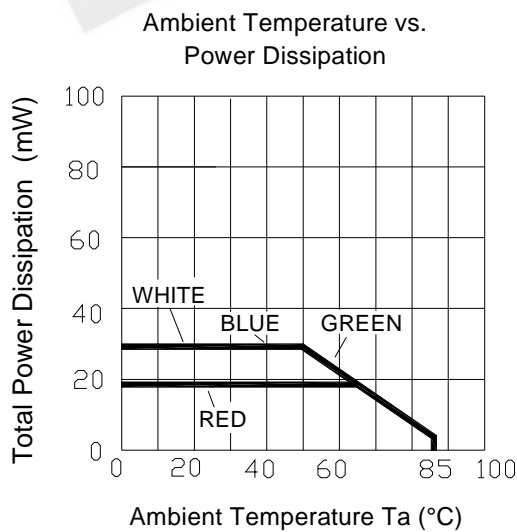
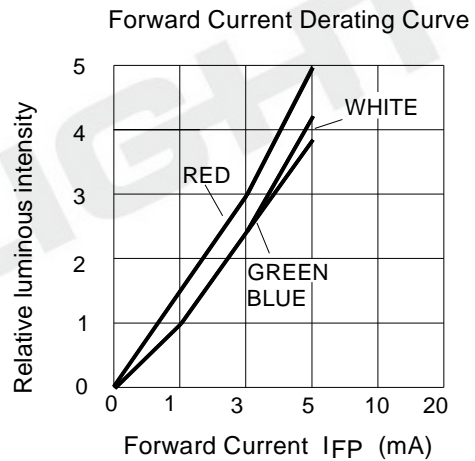
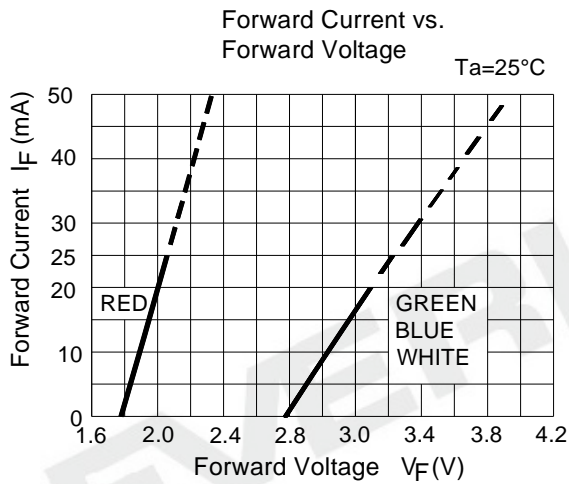
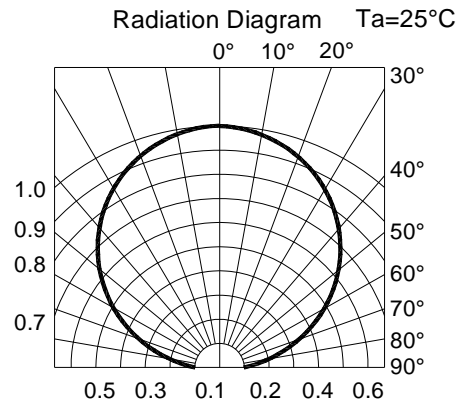
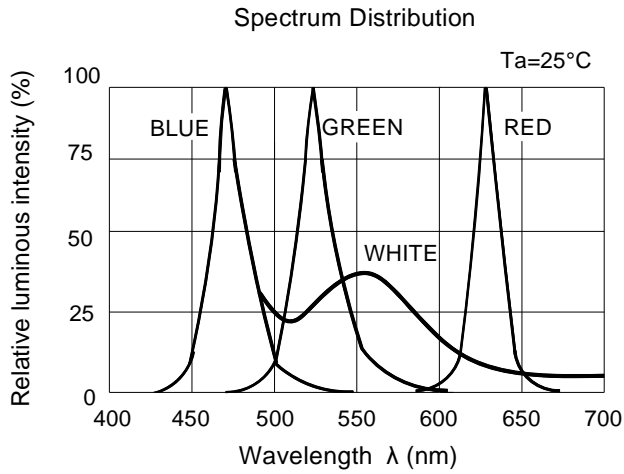

**Package Dimension**

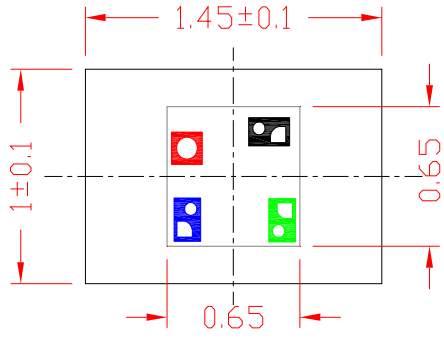

TOP View

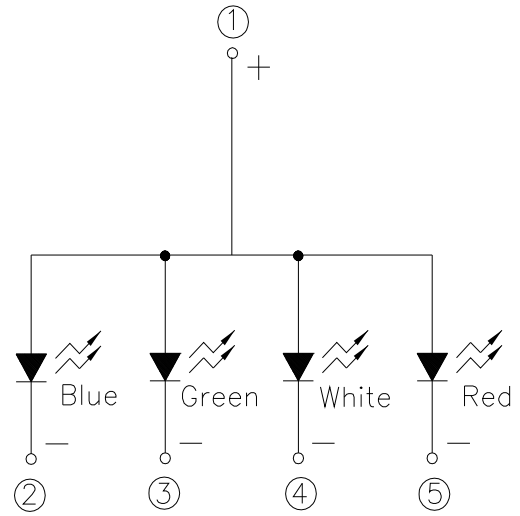
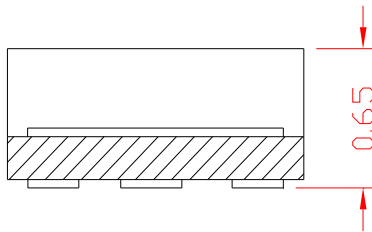

Polarity

Recommend Soldering Pad

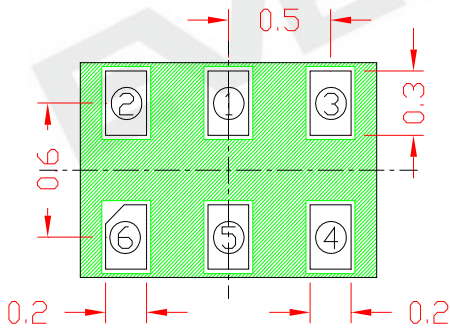

Bot. View

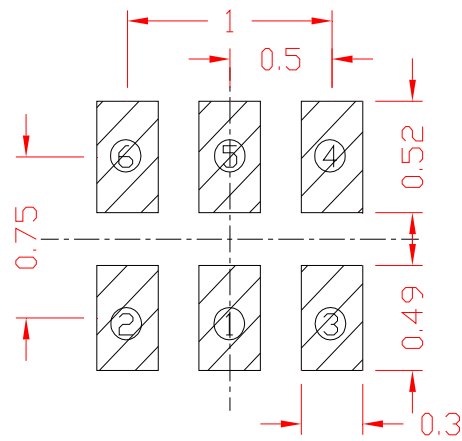

單位：mm 公差：±0.05

Suggested pad dimension is just for reference only.  
Please modify the pad dimension based on individual need.

Note: Tolerances unless mentioned  $\pm 0.1$ mm. Unit = mm  
PAD 6 is only for soldering use, not for electrical use.

## Moisture Resistant Packing Materials

### Label Explanation

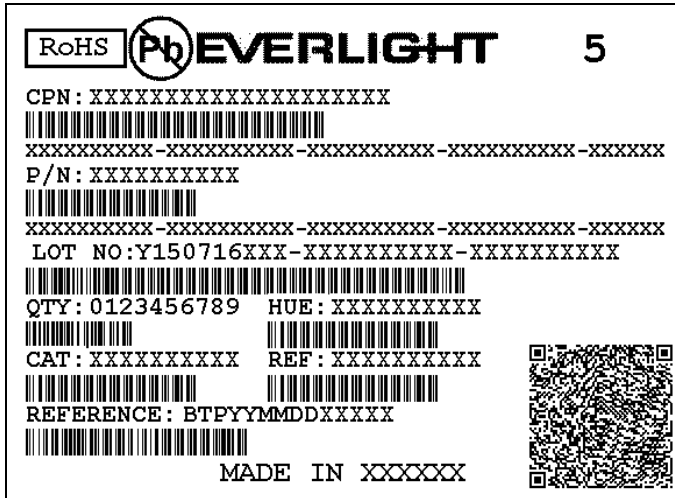

- CPN: Customer's Product Number
- P/N: Product Number
- QTY: Packing Quantity
- CAT: Luminous Intensity Rank
- HUE: Dom. Wavelength Rank
- REF: Forward Voltage Rank
- LOT No: Lot Number

### Reel Dimensions

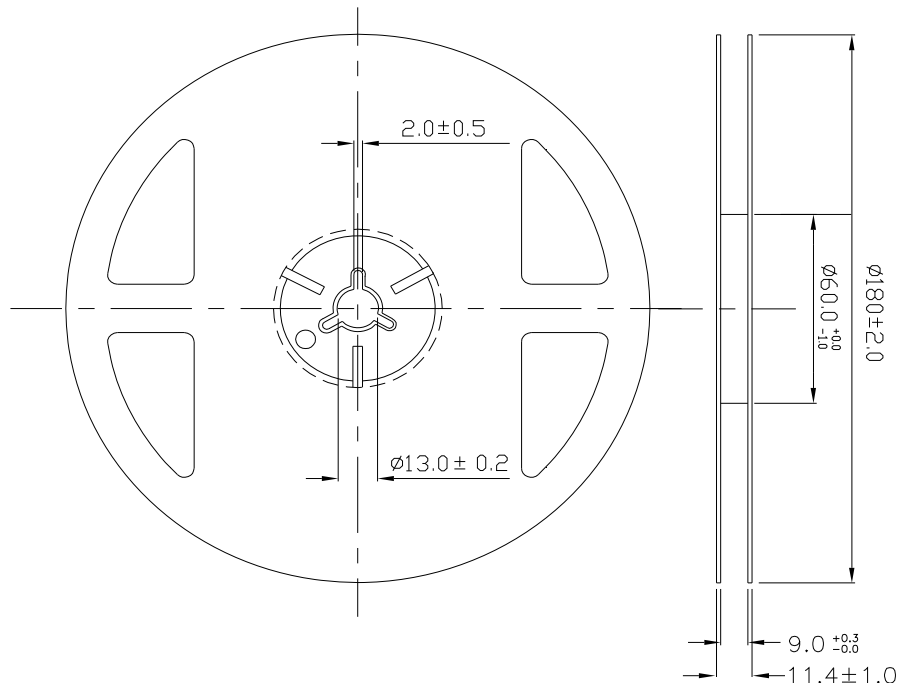

### Carrier Tape Dimensions:

Minimum packing amount is 4000 pcs per reel

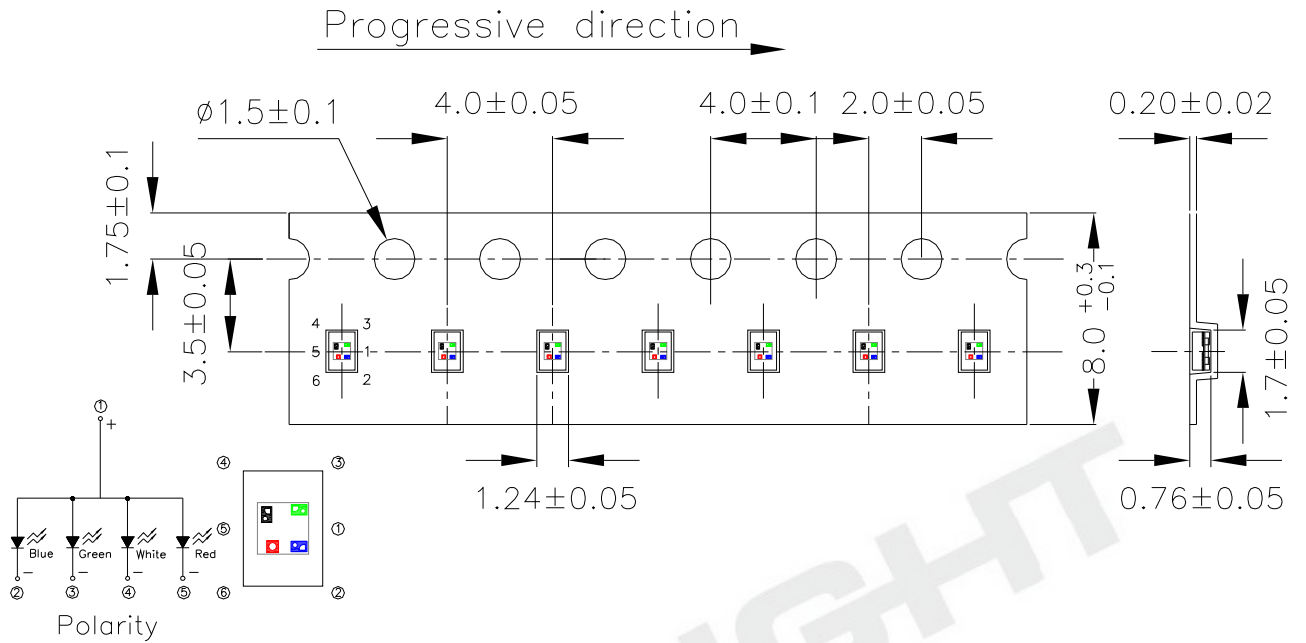

Note: Tolerances unless mentioned  $\pm 0.1$ mm. Unit = mm

### Moisture Resistant Packing Process

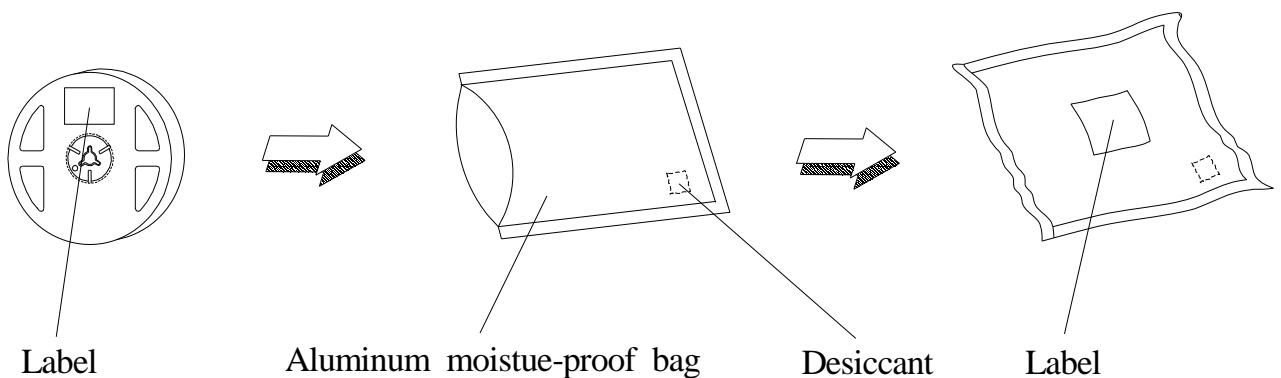

Note: Tolerances unless mentioned  $\pm 0.1$ mm. Unit = mm

## Precautions for Use

### 1. Over-current-proof

Customer must apply resistors for protection, otherwise slight voltage shift will cause big current change ( Burn out will happen ).

### 2. Storage

2.1 Do not open moisture proof bag before the products are ready to use.

2.2 Before opening the package: The LEDs should be kept at 30°C or less and 90%RH or less.

2.3 After opening the package: The LED's floor life is 168Hrs under 30°C or less and 60% RH or less. If unused LEDs remain, it should be stored in moisture proof packages.

2.4 If the moisture absorbent material (silica gel) has faded away or the LEDs have exceeded storage time, baking treatment should be performed using the following conditions.

Baking treatment : 60±5°C for 24 hours.

### 3. Soldering Condition

#### 3.1 Pb-free solder temperature profile

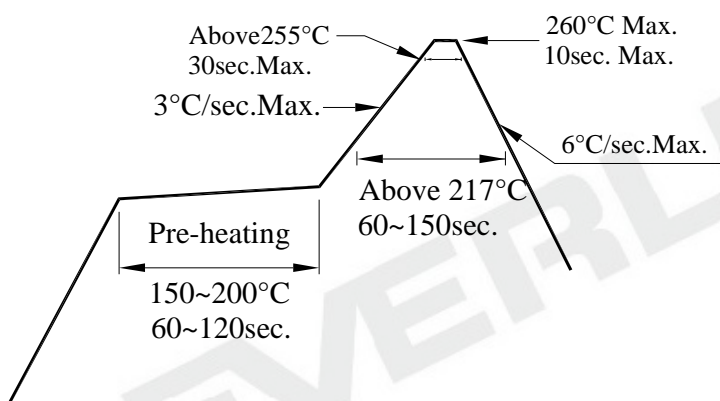

3.2 Reflow soldering should not be done more than two times.

3.3 When soldering, do not put stress on the LEDs during heating.

3.4 After soldering, do not warp the circuit board.

### 4. Soldering Iron

Each terminal is to go to the tip of soldering iron temperature less than 350°C for 3 seconds within once in less than the soldering iron capacity 25W. Leave two seconds and more intervals, and do soldering of each terminal. Be careful because the damage of the product is often started at the time of the hand solder.

## 5.Repairing

Repair should not be done after the LEDs have been soldered. When repairing is unavoidable, a double-head soldering iron should be used (as below figure). It should be confirmed beforehand whether the characteristics of the LEDs will or will not be damaged by repairing.

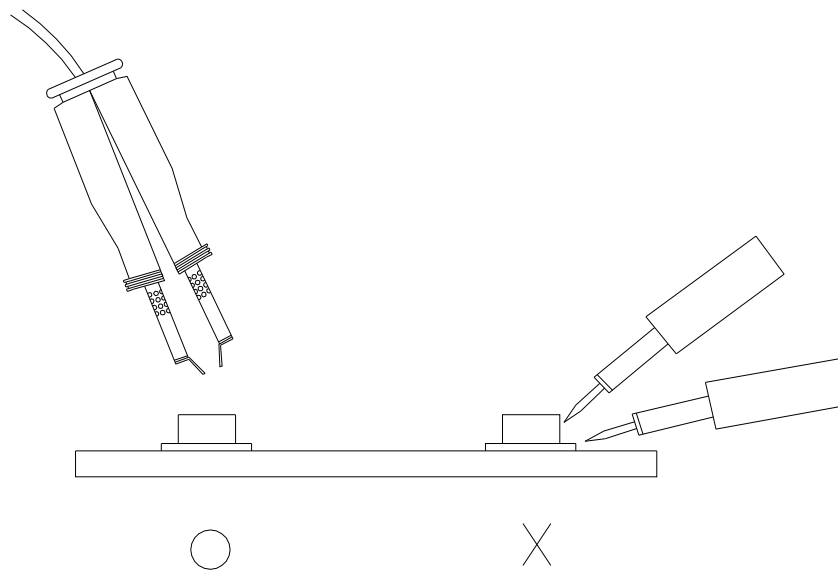

## 6.Directions for use

The LEDs should be operated with forward bias. The driving circuit must be designed so that the LEDs are not subjected to forward or reverse voltage while it is off. If reverse voltage is continuously applied to the LEDs, It may cause migration resulting in LED damage.

## DISCLAIMER

1. EVERLIGHT reserves the right(s) on the adjustment of product material mix for the specification.
2. The product meets EVERLIGHT published specification for a period of twelve (12) months from date of shipment.
3. The graphs shown in this datasheet are representing typical data only and do not show guaranteed values.
4. When using this product, please observe the absolute maximum ratings and the instructions for using outlined in these specification sheets. EVERLIGHT assumes no responsibility for any damage resulting from the use of the product which does not comply with the absolute maximum ratings and the instructions included in these specification sheets.
5. These specification sheets include materials protected under copyright of EVERLIGHT. Reproduction in any form is prohibited without obtaining EVERLIGHT's prior consent.
6. This product is not intended to be used for military, aircraft, automotive, medical, life sustaining or life saving applications or any other application which can result in human injury or death. Please contact authorized Everlight sales agent for special application request.

EVERLIGHT