

### Infrared Receiver Module EAIRMBA4

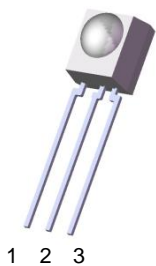

Pin Configuration

1. OUT
2. V<sub>CC</sub>
3. GND

Block Diagram

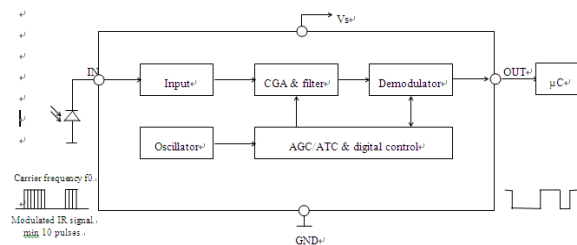

### Features

- Photo detector and preamplifier in one package
- Internal filter for PCM frequency
- Improved inner shielding against electrical field disturbance
- TTL and CMOS compatibility
- Low power consumption
- Improved immunity against ambient light
- Suitable burst length  $\geq 10$  cycles/burst
- Pb free
- BiCMOS manufacture IC ; ESD HBM>4000V ; MM>250V
- The product itself will remain within RoHS compliant version.
- Compliance with EU REACH
- Compliance Halogen Free .(Br <900 ppm ,Cl <900 ppm , Br+Cl < 1500 ppm)

### Description

- The EAIRMBA4 is miniaturized receivers for infrared remote control systems.
- PIN diode and preamplifier are assembled on lead frame, the epoxy package is designed as IR filter. The demodulated output signal can directly be decoded by a microprocessor. EAIRMBA4 is the standard IR remote control receiver series, supporting all major transmission codes.

### Applications

- Light detecting portion of remote control
- AV instruments such as Audio, TV, VCR, CD, MD, etc.
- Home appliances such as Air-conditioner, Fan , etc.
- The other equipments with wireless remote control.
- CATV set top boxes
- Multi-media Equipment

### Application Circuit

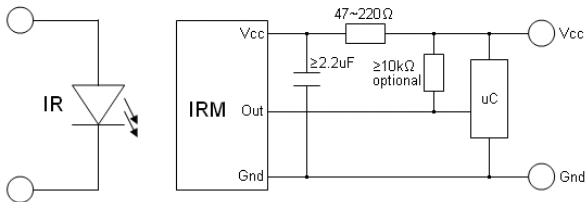

The RC Filter must be connected as close as possible to Vcc and GND pins

### Parts Table

Model No.	Carrier Frequency
EAIRMBA4	38 kHz

### Absolute Maximum Ratings (Ta=25°C)

Parameter	Symbol	Rating	Unit
Supply Voltage	Vcc	6	V
Operating Temperature	Topr	-20 ~ +80	°C
Storage Temperature	Tstg	-40 ~ +85	°C
Soldering Temperature <sup>*1</sup>	Tsol	260	°C

<sup>\*1</sup> 4mm from mold body for less than 10 seconds

**Electro-Optical Characteristics (Ta=25°C, Vcc=3V)**

Parameter	Symbol	Min.	Typ.	Max.	Unit	Condition
Current consumption	I <sub>CC</sub>	---	1.0	1.2	mA	No input signal
Supply voltage	V <sub>CC</sub>	2.7	-	5.5	V	
Peak wavelength	λ <sub>p</sub>	---	940	---	nm	
Reception range	L <sub>0</sub>	14	---	---	m	See chapter ,Test method'
	L <sub>45</sub>	6	---	---		
Half angle(horizontal)	φ <sub>h</sub>	---	±45	---	deg	
Half angle(vertical)	φ <sub>v</sub>	---	±45	---	deg	
High level pulse width	T <sub>H</sub>	400	---	800	μs	Test signal according to figure 1
Low level pulse width	T <sub>L</sub>	400	---	800	μs	
High level output voltage	V <sub>OH</sub>	V <sub>CC</sub> -0.3	---	---	V	I <sub>SOURCE</sub> ≤ 1μA
Low level output voltage	V <sub>OL</sub>	---	0.2	0.5	V	I <sub>SINK</sub> ≤ 2mA

**Notes:**

- \*1. The ray receiving surface at a vertex and relation to the ray axis in the range of θ= 0° and θ=45°.
- \*2. A range from 30cm to the arrival distance. Average value of 50 pulses.

**The Notice of Application:**

Transmission of remote control signal consist of four parts: Encode Part, IR Transmitter Source, IRM device, Decode Part

1. When IRM-36xxT code select frequency, it need to well understand the center system of encode part.
2. Strong or weak light of IR Transmitter can affect distance of transmission.
3. When using IRM-36xxT device, it requires the composition of code pattern to reach the demand as follows:

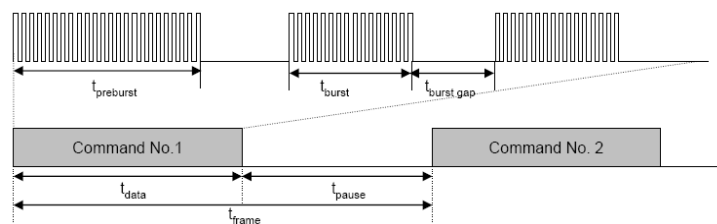

Minimum t <sub>burst</sub> ( number of pulses per burst)	Minimum t <sub>burst_gap</sub> ( number of pulses between two burst)	Minimum t <sub>pause</sub>
10 pulses	14 pulses	25 msec

4. It needs to ensure the translation range of decode part if it is applied to the pulse-width range.  
If the above items hardly assure of its application, it'll cause NG(no good) message from the edge of signal.

### Test method

The specified electro-optical characteristics are valid under the following conditions.

1. Measurement environment  
A place without extreme light reflections.
2. External light  
The environment contains an ordinary, white fluorescent lamp without high frequency modulation. The color temperature is 2856K and the illumination at the IR receiver is less than 10 Lux ( $E_v \leq 10\text{Lux}$ ).
3. Standard transmitter  
The test transmitter is calibrated by using the circuit shown in figure 2. The radiation intensity of the transmitter is adjusted until  $V_o=400\text{mVp-p}$ . Both, the test transmitter and the photo diode, have a peak wavelength of 940nm. The photo diode for calibration is PD438B ( $\lambda_p=940\text{nm}$ ,  $V_r=5\text{V}$ ).
4. The measurement system is shown in Fig.-3

Fig.-1 Transmitter Wave Form

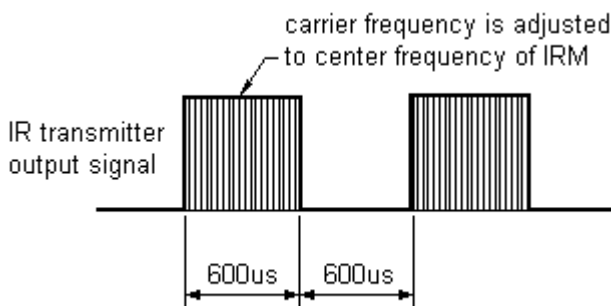
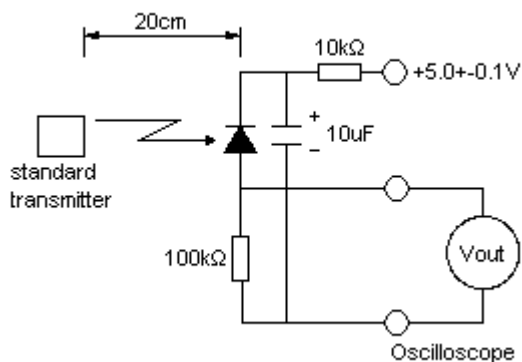

Fig.-2 standard transmitter calibration



D.U.T output Pulse

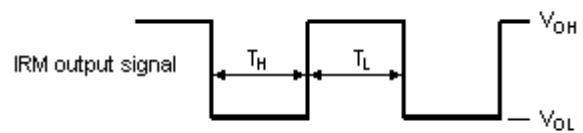
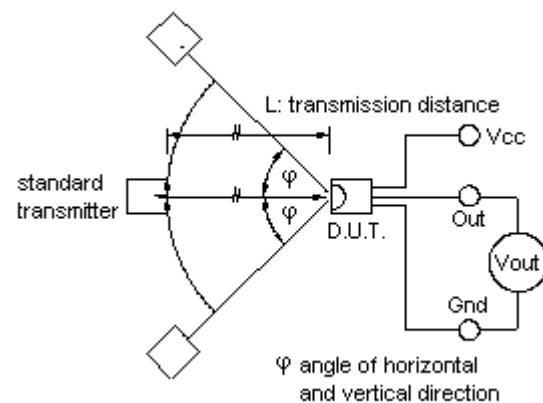

Fig.-3 Measuring System



## Typical Electro-Optical Characteristics Curves

Fig.-4 Relative Spectral Sensitivity vs. Wavelength

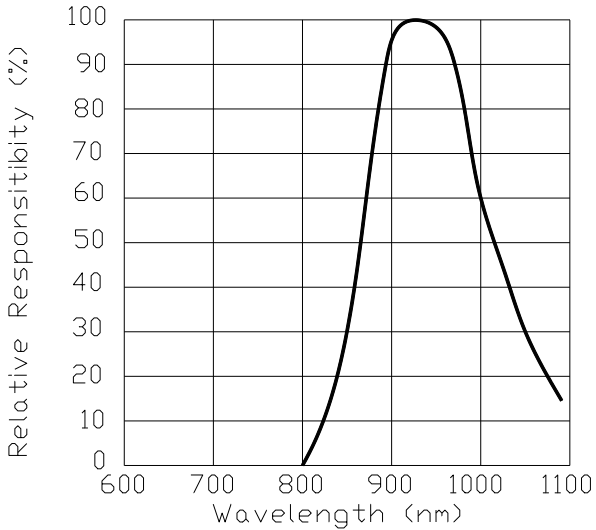

Fig.-5 Relative Transmission Distance vs. Direction

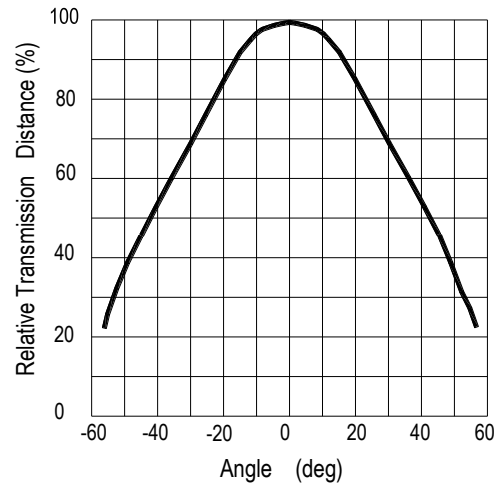

Fig.-6 Output Pulse Length vs. Arrival Distance

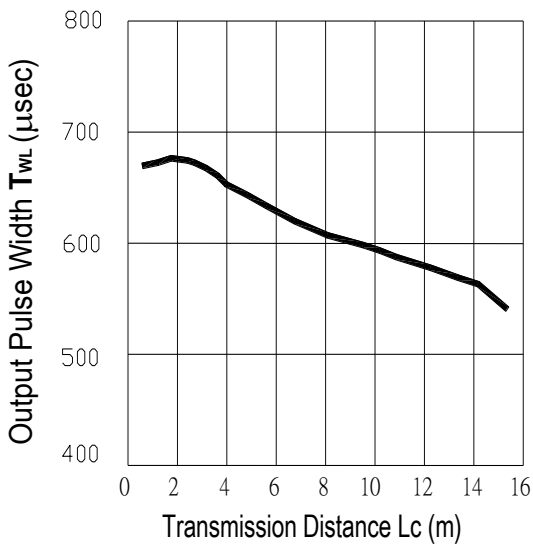

Fig.-7 Arrival Distance vs. Supply Voltage

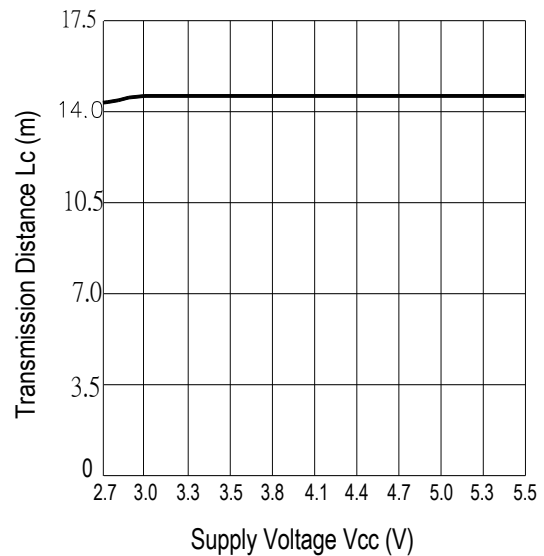

Fig.-8 Relative Transmission Distance vs. Center Carrier Frequency

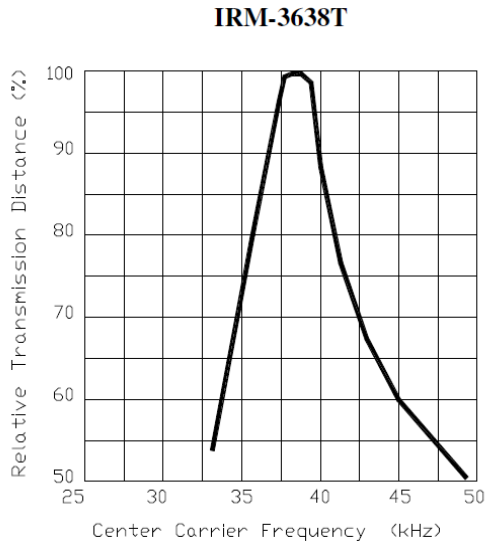
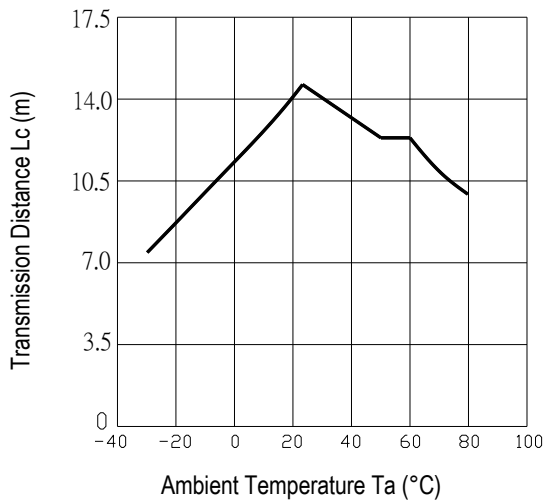

Fig.-9 Arrival Distance vs. Ambient Temperature



### Reliability Test Item And Condition

The reliability of products shall be satisfied with items listed below.

Confidence level : 90%

LTPD : 10%

Test Items	Test Conditions	Failure Judgement Criteria	<u>Samples(n)</u> Defective(c)
Temperature cycle	1 cycle $\xleftrightarrow{-40^{\circ}\text{C}} \quad \xrightarrow{+100^{\circ}\text{C}}$ (15min)(5min)(15min) 300 cycle test	$L_0 \leq L \times 0.8$ $L_{45} \leq L \times 0.8$  L: Lower specification limit	n=22,c=0
High temperature test	Temp: +100°C Vcc:6V 1000hrs		n=22,c=0
Low temperature storage	Temp: -40°C 1000hrs		n=22,c=0
High temperature High humidity	Ta: 85°C ,RH:85% 1000hrs		n=22,c=0
Solder heat	Temp: 260±5°C 10sec 4mm From the bottom of the package.		n=22,c=0

**Package Dimension**  
(Dimensions in mm)

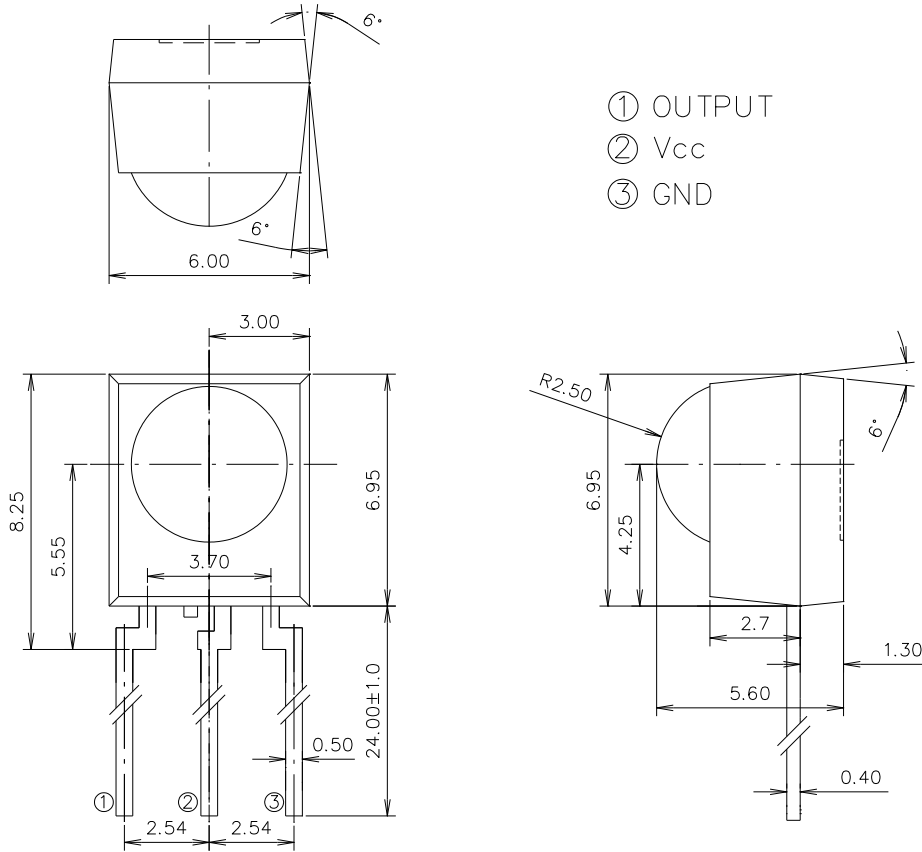

**Notes:**

Tolerance unless otherwise mentioned  $\pm 0.3\text{mm}$

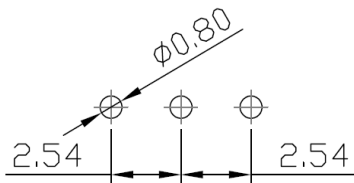



### Code information

Protocol	Suitable	Protocol	Suitable
JVC	Yes	RCA	NO
Matsushita	Yes	Sharp	Yes
Mitsubishi	Yes	Sony 12 Bit	Yes
NEC	Yes	Sony 15 Bit	No
RC5	Yes	Sony 20Bit	No
RC6	Yes	Toshiba	Yes
High data rate (4000 bit/s)	NO	Zenith	Yes

### Device Marking

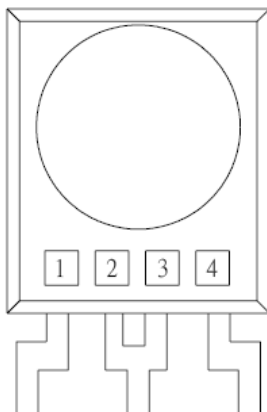

#### Notes

- 1 denotes Year code
- 2 denotes Month code
- 3 denotes Device number
- 4 denotes Carrier frequency ( 4: 38KHz )

### Packing Quantity

1500 pcs / Box  
10 Boxes / Carton

## Application Restrictions

1. Above specification may be changed without notice. Everlight Americas will reserve authority on material change for above specification.
2. When using this product, please observe the absolute maximum ratings and the instructions for use outlined in these specification sheets. Everlight Americas assumes no responsibility for any damage resulting from use of the product which does not comply with the absolute maximum ratings and the instructions included in these specification sheets.
3. These specification sheets include materials protected under copyright of Everlight Americas. Reproduction in any form is prohibited without the specific consent of Everlight Americas