

Display ▪ Through-hole EADCS056RA4

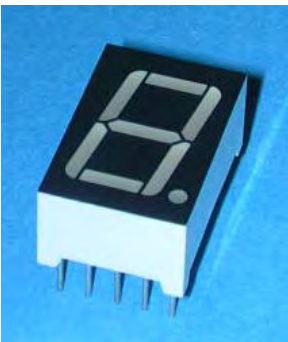

Features

- Industrial standard size.
- Low power consumption.
- Categorized for luminous intensity.
- The product itself will remain with RoHS Compliant version.
- Compliance with EU REACH.
- Compliance with Pb free.

Description

- The EADCS056RA4 is a 14.22mm (0.56") digit height seven-segment display.
- The display provides excellent reliability in bright ambient light.
- The device is made with white segments and black surface.

Applications

- Home appliances
- Instrument panels
- Digital readout displays

Device Selection Guide

Chip Materials	Emitted Color	Resin Color
AlGaInP	Deep-Red	White Diffusion

Absolute Maximum Ratings (Ta=25°C)

Parameter	Symbol	Rating	Unit
Reverse Voltage	V_R	5	V
Forward Current	I_F	25	mA
Peak Forward Current (Duty 1/10 @1KHz)	I_{FP}	60	mA
Power Dissipation	P_d	60	mW
Operating Temperature	T_{opr}	-40 ~ +85	°C
Storage Temperature	T_{stg}	-40 ~ +90	°C
Soldering Temperature	T_{sol}	Wave Soldering : 260 °C for 5 sec. Hand Soldering : 350 °C for 3 sec.	

Electro-Optical Characteristics (Ta=25°C)

Parameter	Symbol	Min.	Typ.	Max.	Unit	Condition
Luminous Intensity ^{*1}	I_v	5.6	12.5	-----	mcd	$I_F=10mA$
Peak Wavelength	λ_p	-----	650	-----	nm	$I_F=20mA$
Dominant Wavelength	λ_d	-----	639	-----	nm	$I_F=20mA$
Spectrum Radiation Bandwidth	$\Delta\lambda$	-----	20	-----	nm	$I_F=20mA$
Forward Voltage	V_F	-----	2.0	2.4	V	$I_F=20mA$
Reverse Current	I_R	-----	-----	100	μA	$V_R=5V$

Note:

- Luminous Intensity is a average value which is measured one 7-segment.
- Tolerance of Luminous Intensity: $\pm 10\%$
- Tolerance of Forward Voltage: $\pm 0.1V$

Typical Electro-Optical Characteristics Curves

Spectrum Distribution (Ta=25°C)

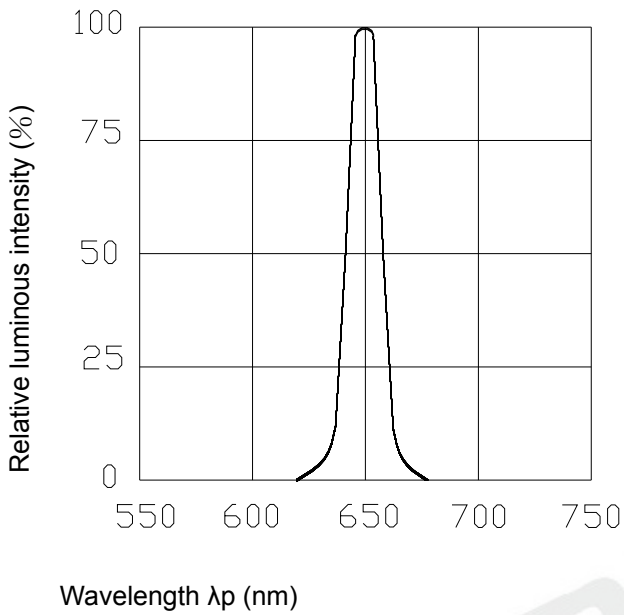

Forward Current vs. Forward Voltage (Ta=25°C)

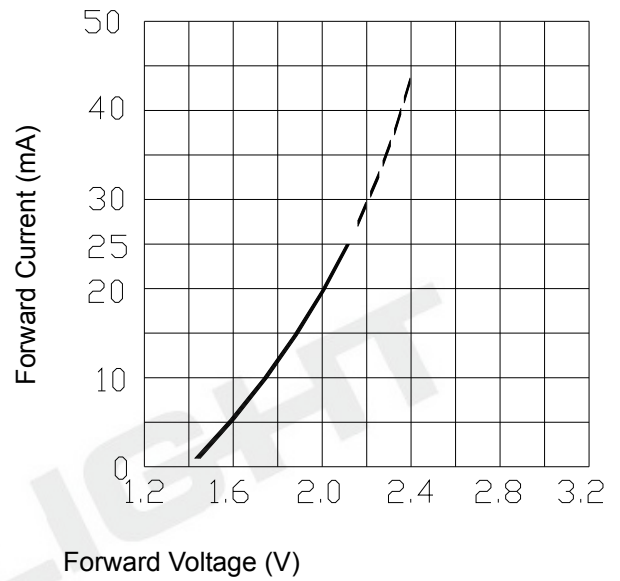

Forward Current Derating Curve

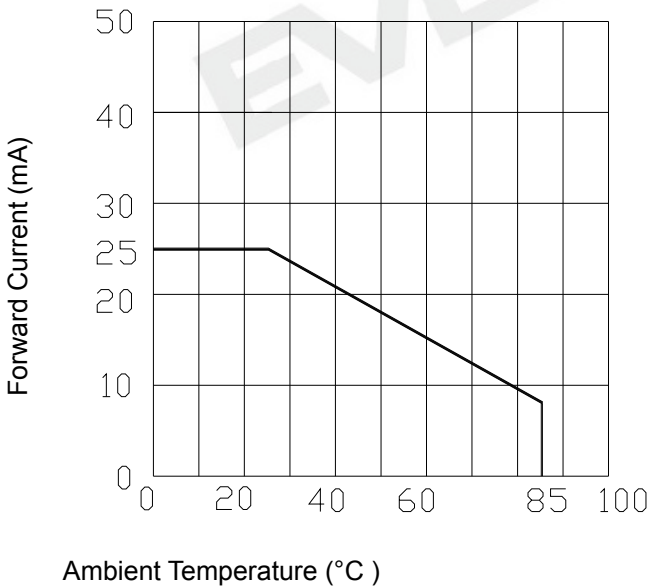

Package Dimension & Internal Circuit Diagram

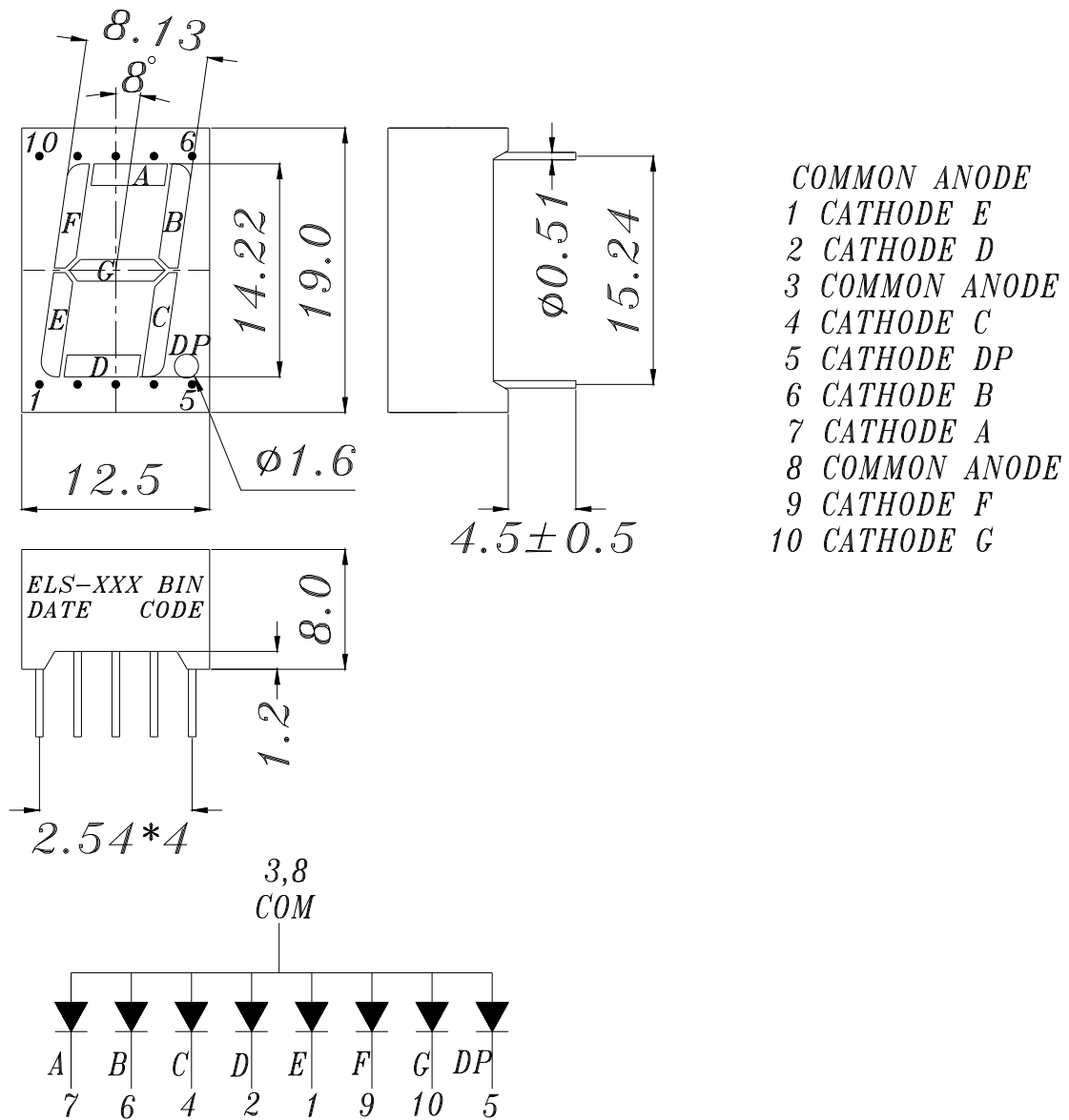

Note: Tolerances unless mentioned ±0.25mm. Unit = mm

Packing Materials

Label Explanation

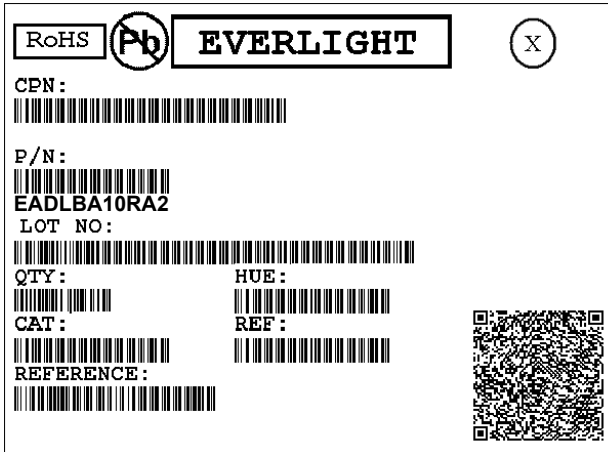

- CPN: Customer's Product Number
- P/N: Product Number
- QTY: Packing Quantity
- CAT: Luminous Intensity Rank
- HUE: Reference
- REF: Reference
- LOT No: Lot Number
- REFERENCE: Volume Label code

Packing Process

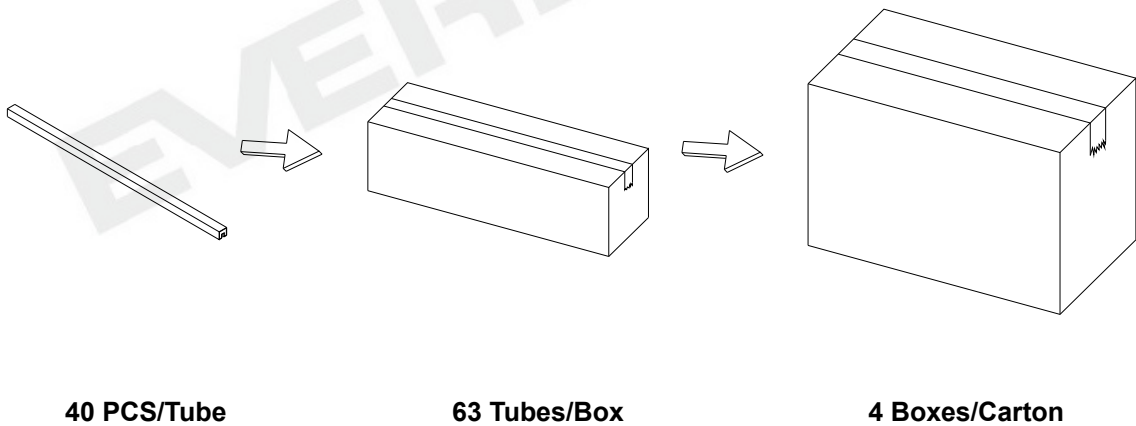

Precautions for Use

1. Soldering Condition

1.1 Maximum Body Case Temperature Profile for evaluation of DIP Soldering Profile

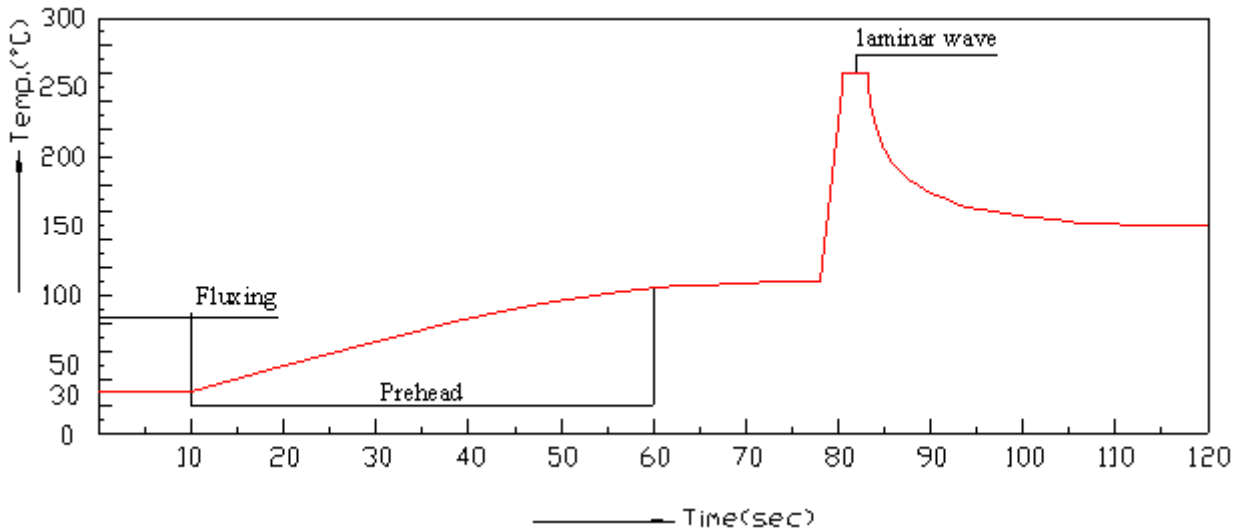

Note:

Preheat

Temperature	100 °C
Time	60 seconds max.

Other

Bath Temperature	260C
Bath Time	5 seconds max.
DIP Soldering	1 time

All parameters are maximum body case temperature values and cannot be considered as a soldering profile. The body case temperature was measured by soldering a thermal couple to the soldering point of LEDs.

2. Soldering Iron

Each terminal is to go to the tip of soldering iron temperature less than 350°C for 3 seconds within once in less than the soldering iron capacity 25W. Leave two seconds and more intervals, and do soldering of each terminal. Be careful because the damage of the product is often started at the time of the hand solder.

DISCLAIMER

1. EVERLIGHT reserves the right(s) on the adjustment of product material mix for the specification.
2. The Product meet EVERLIGHT published specification for a period of twelve(12) months from date of shipment.
3. The graphs shown in this datasheet are representing typical data only and do not show guaranteed values.
4. When using this product, please observe the absolute maximum ratings and the instructions for using outlined in these specification sheets. EVERLIGHT assumes no responsibility for any damage resulting from the use of the product which does not comply with the absolute maximum ratings and the instructions included in these specification sheets.
5. These specification sheets include materials protected under copyright of EVERLIGHT. Reproduction in any form is prohibited without obtaining EVERLIGHT's prior consent.
6. This product is not intended to be used for military, aircraft, automotive, medical, life sustaining or life saving applications or any other application which can result in human injury or death. Please contact authorized Everlight sales agent for special application request.
7. ESD (Electrostatic Discharge)
 - The products are sensitive to static electricity or surge voltage. ESD can damage a die and its reliability. When handling the products, the following measures against electrostatic discharge are strongly recommended:
 - Eliminating the charge
 - Grounded wrist strap, ESD footwear, clothes, and floors
 - Grounded workstation equipment and tools
 - ESD table/shelf mat made of conductive materials
 - Proper grounding is required for all devices, equipment, and machinery used in product assembly. Surge protection should be considered when designing of commercial products.
 - If tools or equipment contain insulating materials such as glass or plastic, the following measures against electrostatic discharge are strongly recommended:
 - Dissipating static charge with conductive materials
 - Preventing charge generation with moisture
 - Neutralizing the charge with ionizers
8. The LEDs should be operated with forward bias. The driving circuit must be designed so that the LEDs are not subjected to forward or reverse voltage while it is off. If reverse voltage is continuously applied to the LEDs, it may cause migration resulting in LED damage.