

### EAST16085OGA0

#### Features

- Package in 8mm tape on 7" diameter reel.
- Compatible with automatic placement equipment.
- Compatible with infrared and vapor phase reflow solder process.
- Mono-color type.
- Pb-free.
- The product itself will remain within RoHS compliant version.

#### Descriptions

- The EAST16085 SMD LED is much smaller than lead frame type components, thus enable smaller board size, higher packing density, reduced storage space and finally smaller equipment to be obtained.
- Besides, lightweight makes them ideal for miniature applications. etc.

#### Applications

- Backlighting in dashboard and switch.
- Telecommunication: indicator and backlighting in telephone and fax.
- Flat backlight for LCD, switch and symbol.
- General use.

### Device Selection Guide

Chip			Resin Color
Type	Material	Emitted Color	
S2	AlGaInP	Brilliant Orange	Water Clear
GH	InGaN	Brilliant Green	

### Package Outline Dimensions

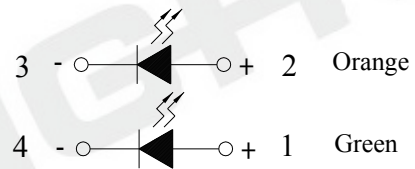
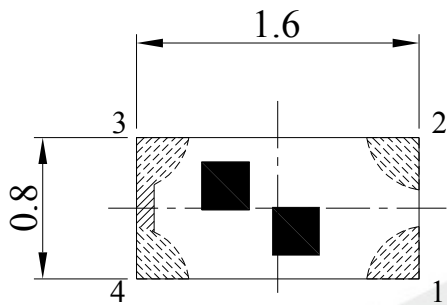

Polarity

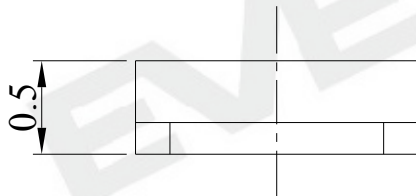

Recommend Soldering Pad

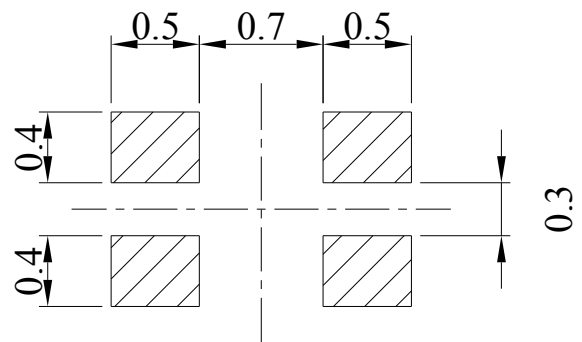
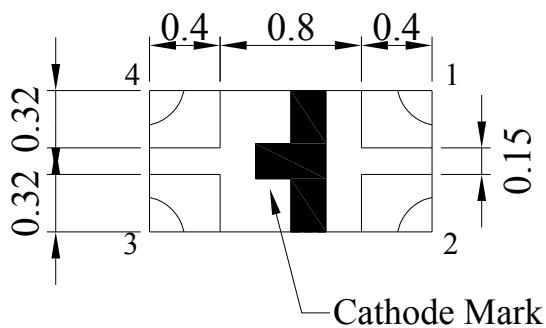

**Note:** The tolerances unless mentioned is  $\pm 0.1\text{mm}$ , Unit = mm

**Absolute Maximum Ratings (Ta=25°C)**

Parameter	Symbol	Rating	Unit
Reverse Voltage	V <sub>R</sub>	5	V
Forward Current	I <sub>F</sub>	S2:25 GH:25	mA
Peak Forward Current (Duty 1/10 @1KHz)	I <sub>FP</sub>	S2:60 GH:100	mA
Power Dissipation	P <sub>d</sub>	S2:60 GH:95	mW
Electrostatic Discharge (HBM)	ESD	S2:2000 GH:150	V
Operating Temperature	T <sub>opr</sub>	-40 ~ +85	°C
Storage Temperature	T <sub>stg</sub>	-40 ~ +90	°C
Soldering Temperature	T <sub>sol</sub>	Reflow Soldering : 260 °C for 10 sec. Hand Soldering : 350 °C for 3 sec.	

**Electro-Optical Characteristics (Ta=25°C)**

Parameter	Symbol	Min.	Typ.	Max.	Unit	Condition
Luminous Intensity	I <sub>v</sub> S2	18.0	-----	45.0	mcd	I <sub>F</sub> =5mA
	GH	72.0		180		
Viewing Angle	2θ 1/2	-----	120	-----	deg	
Peak Wavelength	λ <sub>p</sub> S2	-----	611	-----	nm	
	GH		518			
Dominant Wavelength	λ <sub>d</sub> S2	600	-----	610	nm	
	GH	520		535		
Spectrum Radiation Bandwidth	Δλ S2	-----	17	-----	nm	
	GH		35			
Forward Voltage	V <sub>F</sub> S2	1.6	-----	2.2	V	
	GH	2.6		3.2		
Reverse Current	I <sub>R</sub> S2	-----	-----	10	μA	V <sub>R</sub> =5V
	GH			50		

**Notes:**

1. Tolerance of Luminous Intensity ±11%
2. Tolerance of Dominant Wavelength ±1nm

## S2

### Bin Range Of Luminous Intensity

Bin	Min	Max	Unit	Condition
M	18.0	28.5	mcd	If=5mA
N	28.5	45.0		

### Bin Range Of Dom. Wavelength

Bin	Min	Max	Unit	Condition
A	600	605	nm	If=5mA
B	605	610		

## GH

### Bin Range Of Luminous Intensity

Bin	Min	Max	Unit	Condition
Q	72.0	112	mcd	If=5mA
R	112	180		

### Bin Range Of Dom. Wavelength

Bin	Min	Max	Unit	Condition
X	520	525	nm	If=5mA
Y	525	530		
Z	530	535		

### Notes:

1. Tolerance of Luminous Intensity  $\pm 11\%$
2. Tolerance of Dominant Wavelength  $\pm 1\text{nm}$

## Typical Electro-Optical Characteristics Curves

S2

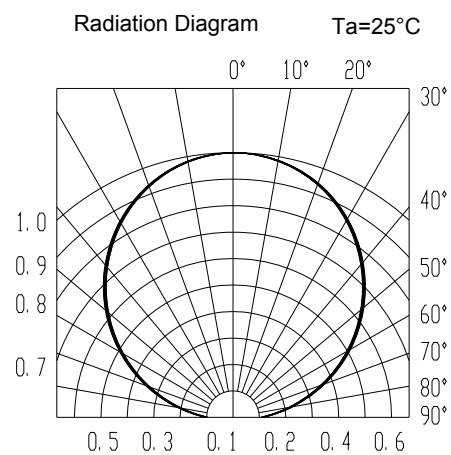
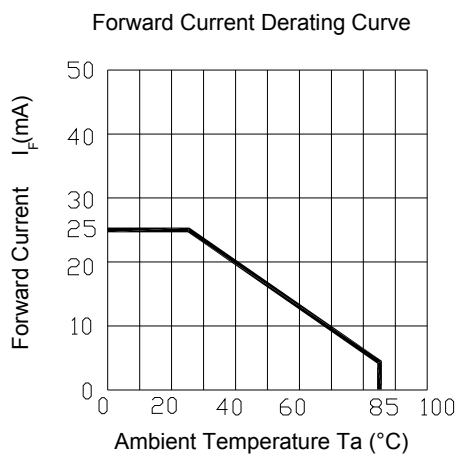
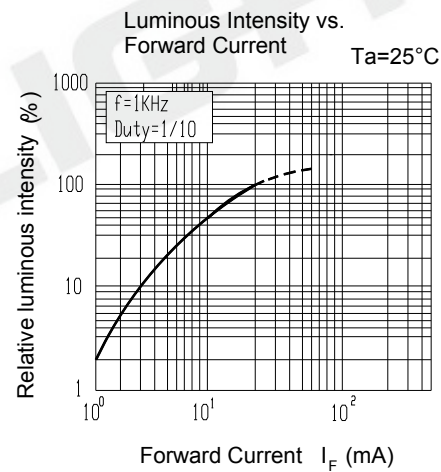
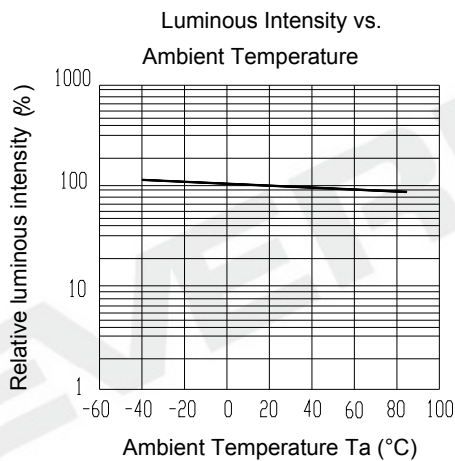
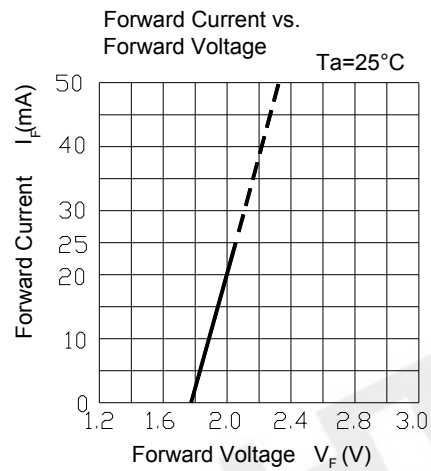
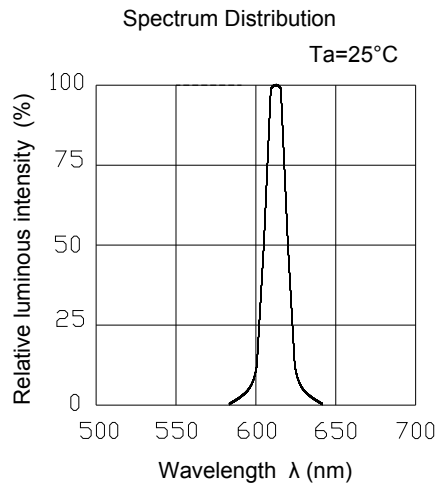

## Typical Electro-Optical Characteristics Curves

**GH**

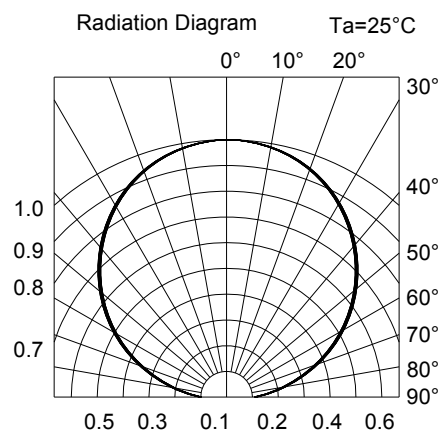
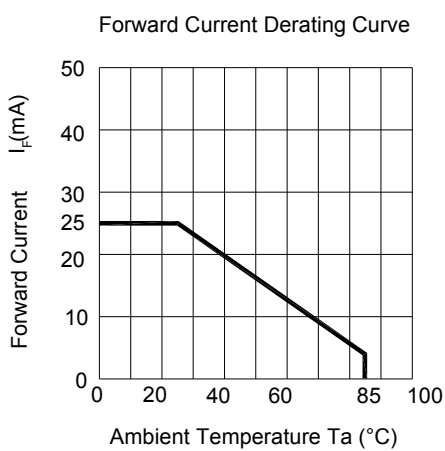
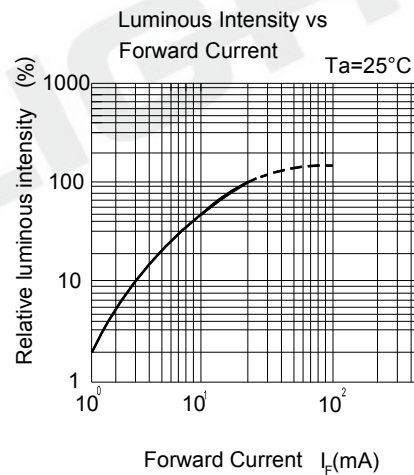
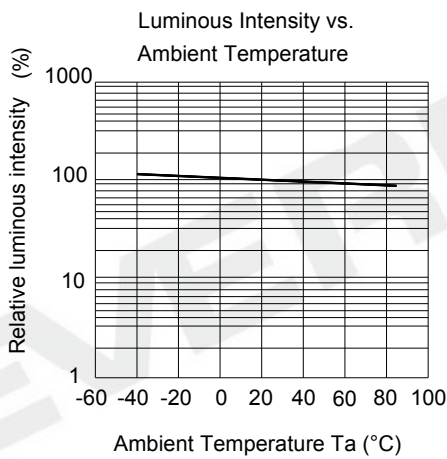
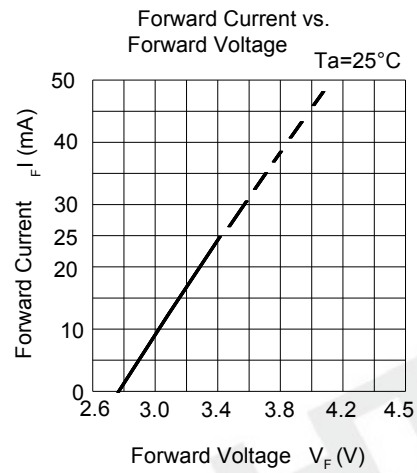
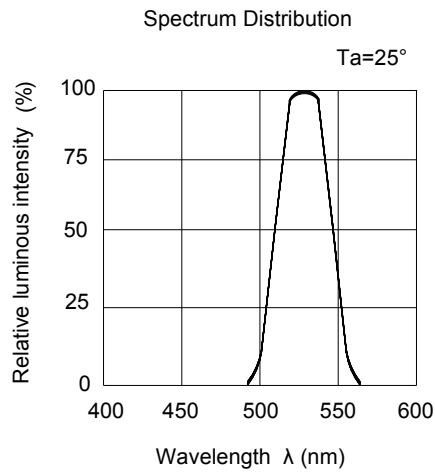

### Label Explanation

**CAT:** Luminous Intensity Rank

**HUE:** Dom. Wavelength Rank

**REF:** Forward Voltage Rank



### Reel Dimensions

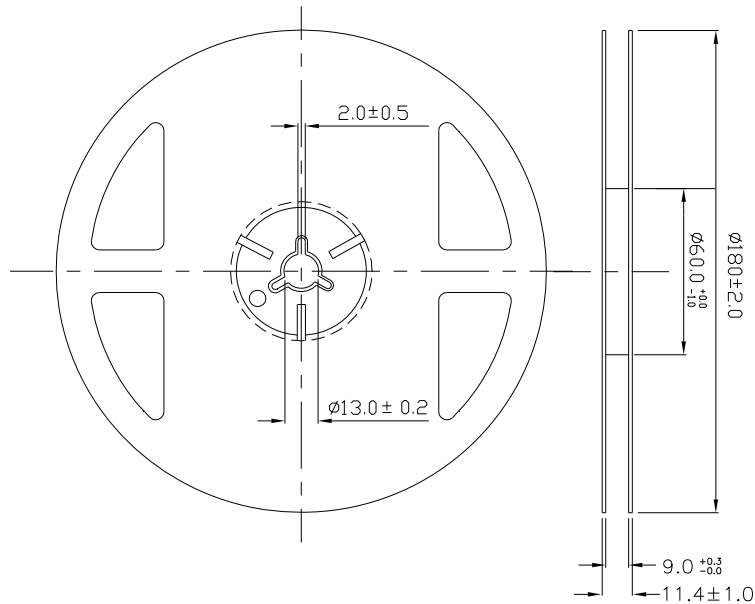

**Note:** The tolerances unless mentioned is  $\pm 0.1\text{mm}$ , Unit = mm



### Carrier Tape Dimensions: Loaded quantity 3000 PCS per reel

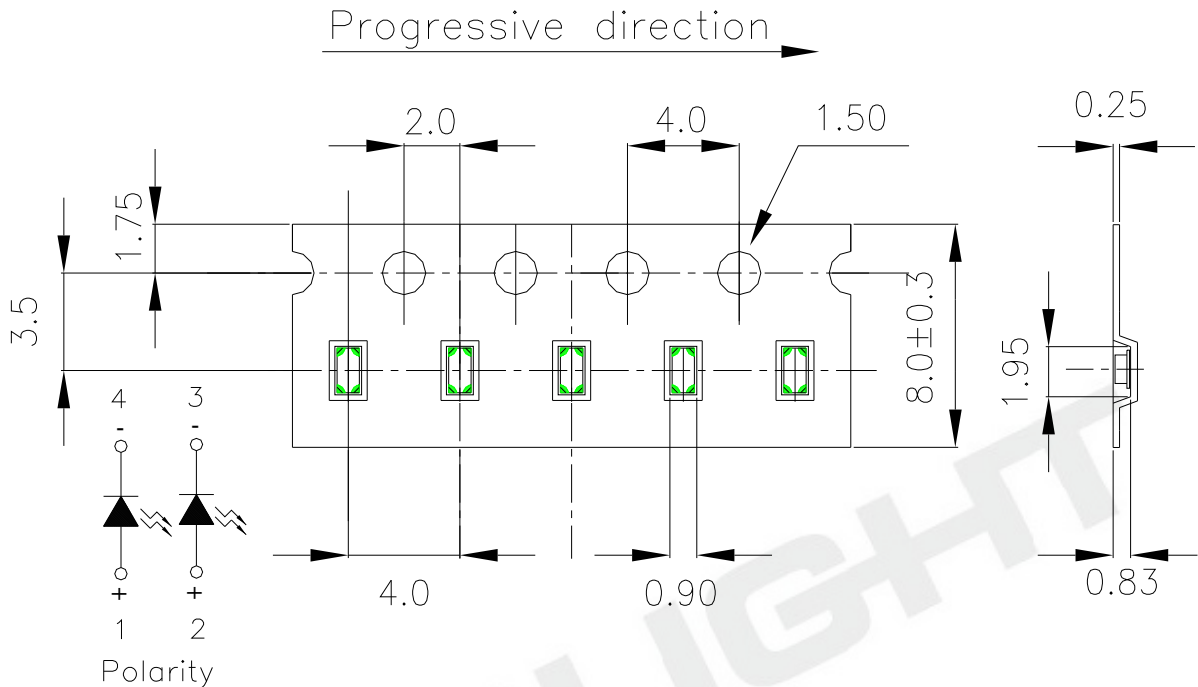

**Note:** The tolerances unless mentioned is  $\pm 0.1$  mm, Unit = mm

### Moisture Resistant Packaging

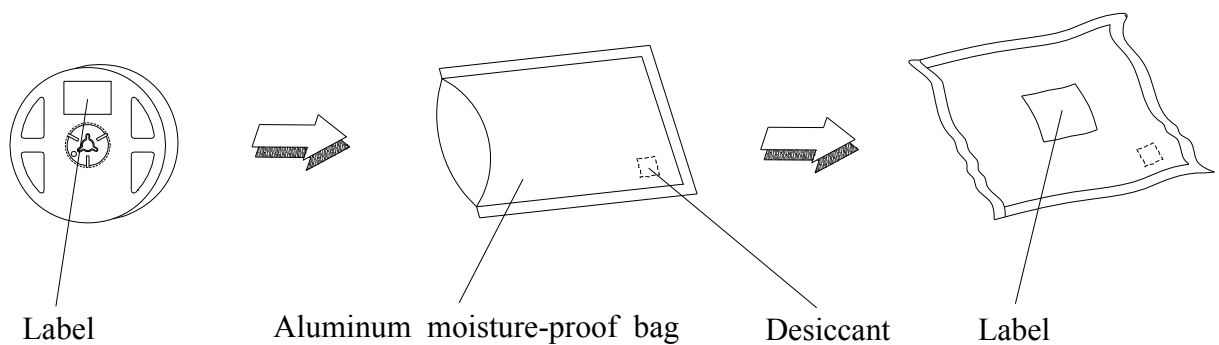

### Reliability Test Items And Conditions

The reliability of products shall be satisfied with items listed below.

Confidence level : 90%

LTPD : 10%

No.	Items	Test Condition	Test Hours/Cycles	Sample Size	Ac/Re
1	Reflow Soldering	Temp. : 260°C±5°C Max. 10sec.	6 Min.	22 PCS.	0/1
2	Temperature Cycle	H : +100°C 15min ∫ 5 min L : -40°C 15min	300 Cycles	22 PCS.	0/1
3	Thermal Shock	H : +100°C 5min ∫ 10 sec L : -10°C 5min	300 Cycles	22 PCS.	0/1
4	High Temperature Storage	Temp. : 100°C	1000 Hrs.	22 PCS.	0/1
5	Low Temperature Storage	Temp. : -40°C	1000 Hrs.	22 PCS.	0/1
6	DC Operating Life	IF = 20 mA	1000 Hrs.	22 PCS.	0/1
7	High Temperature / High Humidity	85°C/ 85%RH	1000 Hrs.	22 PCS.	0/1

## Precautions For Use

### 1. Over-current-proof

Customer must apply resistors for protection, otherwise slight voltage shift will cause big current change ( Burn out will happen ).

### 2. Storage

2.1 Do not open moisture proof bag before the products are ready to use.

2.2 Before opening the package: The LEDs should be kept at 30°C or less and 90%RH or less.

2.3 After opening the package: The LED's floor life is 1 year under 30°C or less and 60% RH or less.

If unused LEDs remain, it should be stored in moisture proof packages.

2.4 If the moisture absorbent material (silica gel) has faded away or the LEDs have exceeded the storage time, baking treatment should be performed using the following conditions.

Baking treatment : 60±5°C for 24 hours.

### 3. Soldering Condition

#### 3.1 Pb-free solder temperature profile

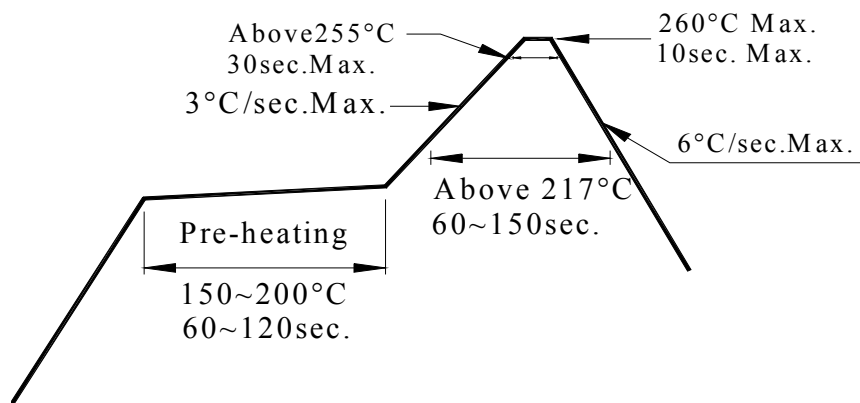

3.2 Reflow soldering should not be done more than two times.

3.3 When soldering, do not put stress on the LEDs during heating.

3.4 After soldering, do not warp the circuit board.

#### 4.Soldering Iron

Each terminal is to go to the tip of soldering iron temperature less than  $350^{\circ}\text{C}$  for 3 seconds within once in less than the soldering iron capacity 25W. Leave two seconds and more intervals, and do soldering of each terminal. Be careful because the damage of the product is often started at the time of the hand solder.

#### 5.Repairing

Repair should not be done after the LEDs have been soldered. When repairing is unavoidable, a double-head soldering iron should be used (as below figure). It should be confirmed beforehand whether the characteristics of the LEDs will or will not be damaged by repairing.

