

### EAPL3020RA1



#### Features

- P-LCC-2 package
- White package
- Optical indicator
- Colorless clear window
- Wide viewing angle
- Suitable for vapor-phase reflow, infrared reflow and wave solder processes
- Computable with automatic placement equipment
- Available on tape and reel (8mm Tape)
- Pb-free
- The product itself will remain within RoHS compliant version.

#### Descriptions

- The EAPL3020RA1 series is available in soft orange, green, blue and yellow. Due to the package design, the LED has wide viewing angle and optimized light coupling by inter reflector. This feature makes the device ideal for light pipe application. The low current requirement makes this device ideal for portable equipment or any other application where power is at a premium.

#### Applications

- Telecommunication: indicator and backlighting in telephone and fax
- Flat backlight for LCD, switch and symbol
- Light pipe application
- General use

### Device Selection Guide

<b>Chip</b>	<b>Emitted Color</b>	<b>Resin Color</b>
<b>Material</b>		
AlGaInP	Brilliant Red	Water Clear

EVERLIGHT

### Package Outline Dimensions

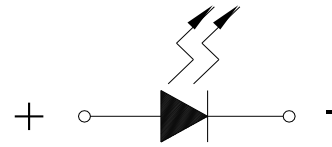
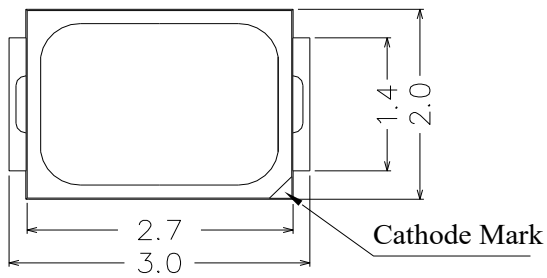

Polarity

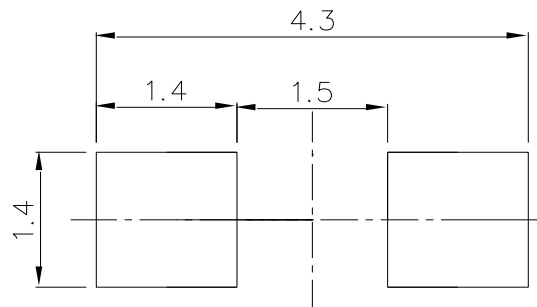
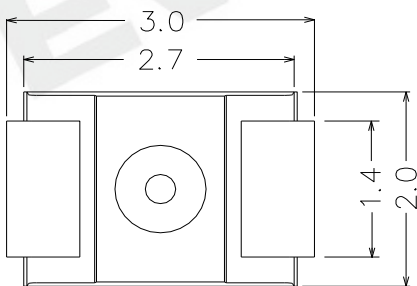
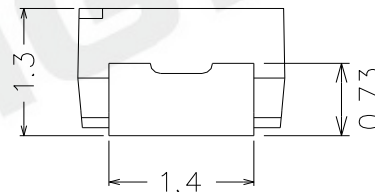
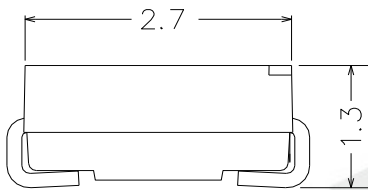

Recommended soldering pad design

**Note:** Tolerances unless mentioned are  $\pm 0.1$ mm, unit = mm.

### Absolute Maximum Ratings (Ta=25°C)

Parameter	Symbol	Rating	Unit
Reverse Voltage	V <sub>R</sub>	5	V
Forward Current	I <sub>F</sub>	25	mA
Peak Forward Current (Duty 1/10 @1KHz)	I <sub>FP</sub>	60	mA
Power Dissipation	P <sub>d</sub>	60	mW
Electrostatic Discharge(HBM)	ESD	2000	V
Operating Temperature	T <sub>opr</sub>	-40 ~ +85	°C
Storage Temperature	T <sub>stg</sub>	-40 ~ +90	°C
Soldering Temperature	T <sub>sol</sub>	Reflow Soldering : 260°C for 10 sec. Hand Soldering : 350°C for 3 sec.	

### Electro-Optical Characteristics (Ta=25°C)

Parameter	Symbol	Min.	Typ.	Max.	Unit	Condition
Luminous Intensity	I <sub>v</sub>	140	----	360	mcd	I <sub>F</sub> =20mA
Viewing Angle	2θ <sub>1/2</sub>	----	120	----	deg	
Peak Wavelength	λ <sub>p</sub>	----	632	----	nm	
Dominant Wavelength	λ <sub>d</sub>	617.5	----	633.5	nm	
Spectrum Radiation Bandwidth	Δλ	----	20	----	nm	
Forward Voltage	V <sub>F</sub>	1.75	----	2.35	V	
Reverse Current	I <sub>R</sub>	----	----	10	μA	V <sub>R</sub> =5V

**Notes:**

1. Tolerance of Luminous Intensity: ±11%
2. Tolerance of Dominant Wavelength: ±1nm
3. Tolerance of Forward Voltage: ±0.1V

### Bin Range of Luminous Intensity

Bin Code	Min.	Max.	Unit	Conduction
R2	140	180	mcd	I <sub>F</sub> =20mA
S1	180	225		
S2	225	285		
T1	285	360		

### Bin Range of Dominant Wavelength

Groups	Bin	Min	Max	Unit	Condition
A	E4	617.5	621.5	nm	I <sub>F</sub> =20mA
	E5	621.5	625.5		
	E6	625.5	629.5		
	E7	629.5	633.5		

### Bin Range of Forward Voltage

Groups	Bin	Min	Max	Unit	Condition
B	0	1.75	1.95	volt	I <sub>F</sub> =20mA
	1	1.95	2.15		
	2	2.15	2.35		

#### Notes:

1. Tolerance of Luminous Intensity: ±11%
2. Tolerance of Dominant Wavelength: ±1nm
3. Tolerance of Forward Voltage: ±0.1V

## Typical Electro-Optical Characteristics Curves

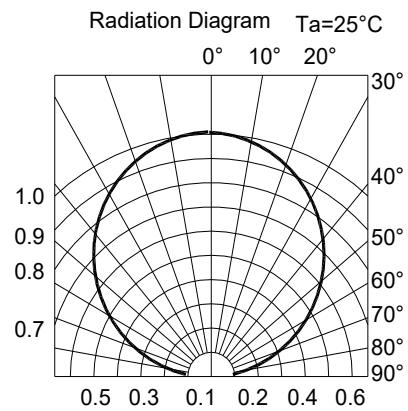
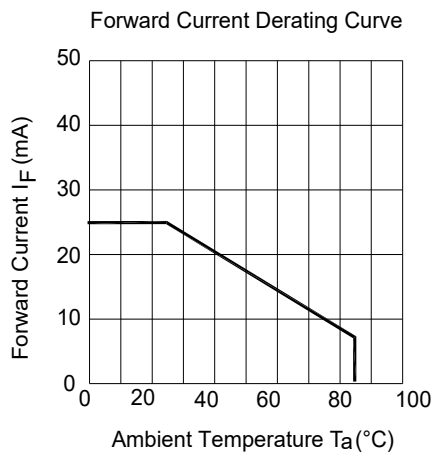
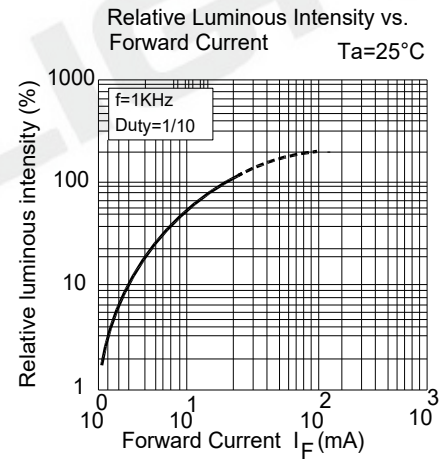
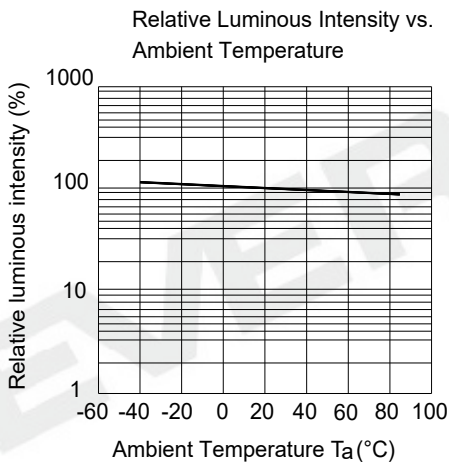
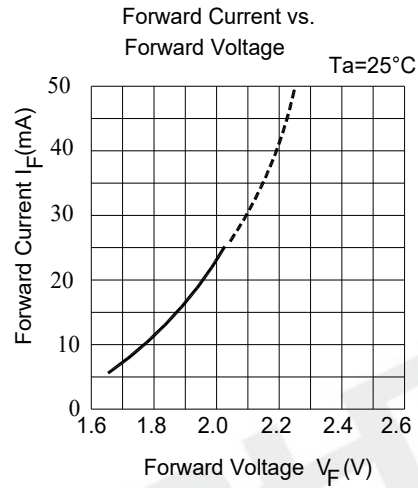
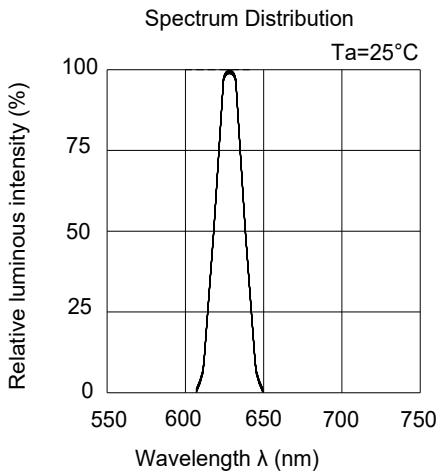

### Label Explanation

CAT: Luminous Intensity Rank

HUE: Dom. Wavelength Rank

REF: Forward Voltage Rank

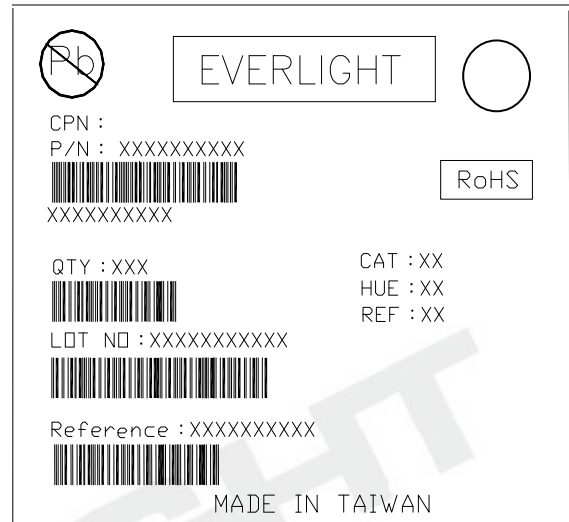

### Reel Dimensions

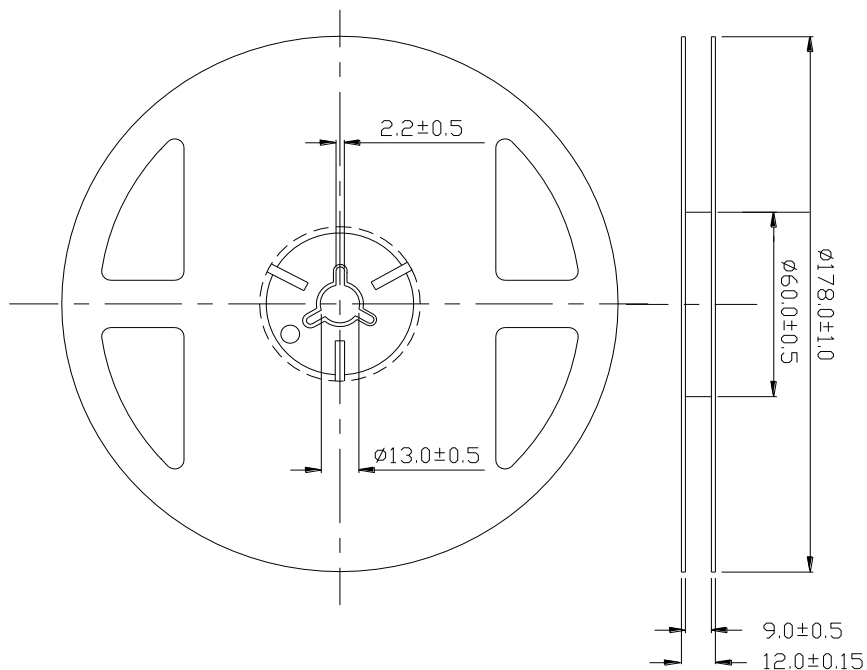

**Note:** Tolerance unless mentioned is  $\pm 0.1$ mm, unit = mm.

**Carrier Tape Dimensions: Loaded Quantity 2000 pcs. Per Reel**

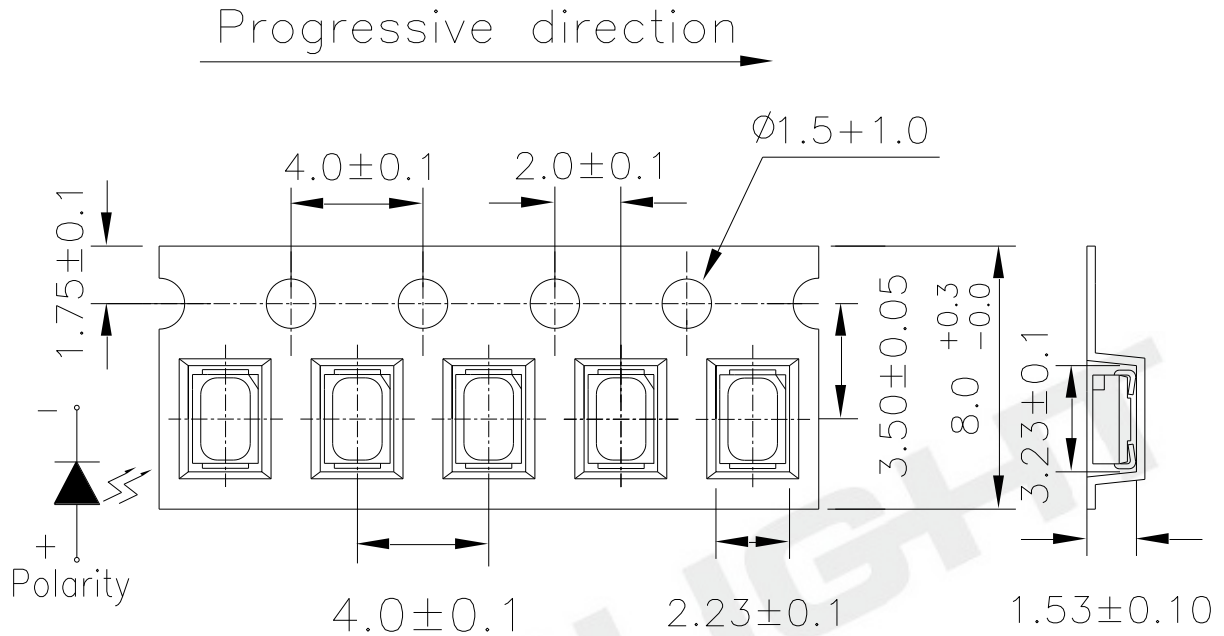

**Note:** Tolerance unless mentioned is  $\pm 0.1$ mm, unit = mm.

**Moisture Resistant Packaging**

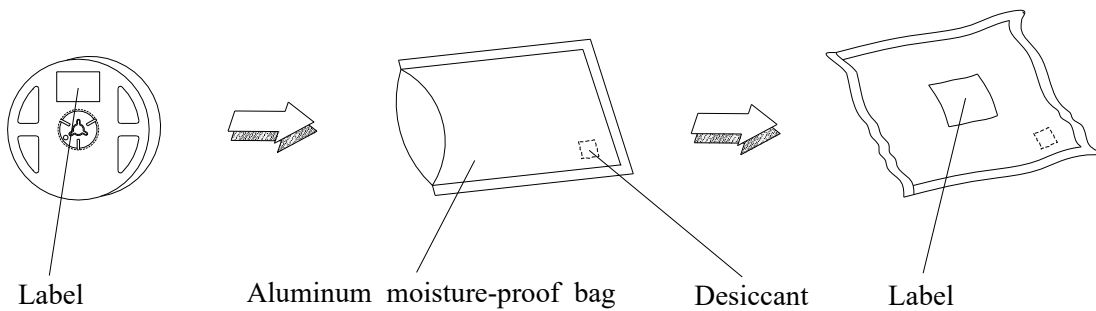



### Reliability Test Items and Conditions

The reliability of products shall be satisfied with items listed below.

Confidence level : 90%

LTPD : 10%

No.	Items	Test Condition	Test Hours/Cycles	Sample Size	Ac/Re
1	Reflow Soldering	Temp. : 260°C±5°C Max. 10sec.	6 Min.	22 pcs.	0/1
2	Temperature Cycle	H : +100°C 15min ↓ 5 min L : -40°C 15min	300 Cycles	22 pcs.	0/1
3	Thermal Shock	H : +100°C 5min ↓ 10 sec L : -10°C 5min	300 Cycles	22 pcs.	0/1
4	High Temperature Storage	Temp. : 100°C	1000 Hrs.	22 pcs.	0/1
5	Low Temperature Storage	Temp. : -40°C	1000 Hrs.	22 pcs.	0/1
6	DC Operating Life	I <sub>F</sub> = 20 mA/ 25°C	1000 Hrs.	22 pcs.	0/1
7	High Temperature / High Humidity	85°C/ 85%RH	1000 Hrs.	22 pcs.	0/1

## Precautions for Use

### 1. Over-current-proof

Customer must apply resistors for protection; otherwise slight voltage shift will cause big current change (Burn out will happen).

### 2. Storage

2.1 Do not open moisture proof bag before the products are ready to use.

2.2 Before opening the package: The LEDs should be used within one year and kept at 30°C or less and 70%RH or less.

2.3 After opening the package: We recommend that the LED should be soldered quickly (within 3 days). The soldering condition is 30°C or less and 60% RH or less. If unused LEDs remain, it should be stored in moisture proof packages.

2.4 If the moisture absorbent material (silica gel) has faded away or the LEDs have exceeded the storage time, baking treatment should be performed using the following conditions.

Baking treatment: 60±5°C for 24 hours.(One time only)

### 3. Soldering Condition

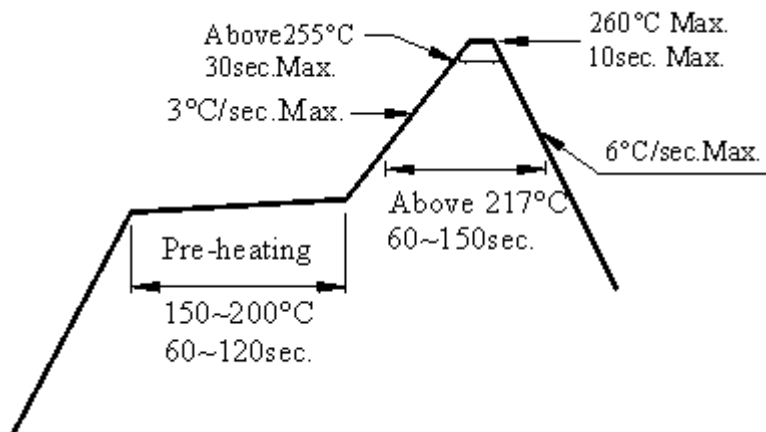

#### 3.1 Pb-free solder temperature profile

3.2 Reflow soldering should not be done more than two times.

3.3 When soldering, do not put stress on the LEDs during heating.

3.4 After soldering, do not warp the circuit board.

#### 4. Soldering Iron

Each terminal is to go to the tip of soldering iron temperature less than  $350^{\circ}\text{C}$  for 3 seconds within once in less than the soldering iron capacity 25W. Leave two seconds and more intervals, and do soldering of each terminal. Be careful because the damage of the product is often started at the time of the hand solder.

#### 5. Repairing

Repair should not be done after the LEDs have been soldered. When repairing is unavoidable, a double-head soldering iron should be used (as below figure). It should be confirmed beforehand whether the characteristics of the LEDs will or will not be damaged by repairing.

