

7PIN DIP PHOTO POWER TRIAC PHOTOCOUPLER ELRX223 Series

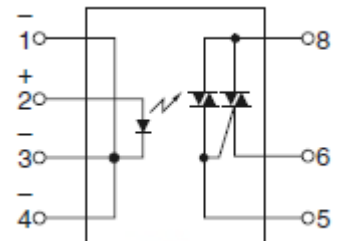
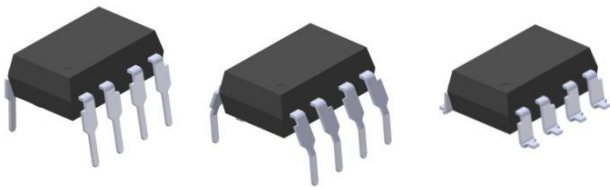

LED Anode	2
LED Cathode	1, 3, 4
Triac Gate	5
Triac T1	6
Triac T2,,	8

Features

- Low trigger current I_{FT} 10mA
- Peak off state voltage 600V
- Load current 0.3 · 0.6 · 0.9 · 1.2A
- Wide operating temperature range of -40°C to 85°C
- High isolation voltage between input and output (Viso=5000 Vrms)
- Pb free and RoHS compliant
- UL and cUL approved (No.E214129)
- VDE approved (No.40028391)
- NEMKO(approved)
- FIMKO(approved)

Description

The ELRX223 series of devices are each consist of a GaAs infrared emitting diode optically coupled to a monolithic silicon random phase photo triac and a main output triac. They are designed for interfacing between electronic controls and loads to control inductive for 115 to 240 VAC operations. They are packaged in 8pin DIP package and available in surface mount SMD option.

Applications

- Home appliances
- Industrial equipment
- Switching motors, fans, heaters, solenoids and valces.
- Power control such as lighting and temperature control

Absolute Maximum Ratings (Ta=25°C, unless otherwise specified)

Parameter		Symbol	Rating	Unit	
Input	Forward Current	I_F	60	mA	
	Reverse Voltage	V_R	6	V	
	Peak Forward Current* ¹	I_{FP}	1	A	
Output	Repetitive peak OFF-state Voltage* ²	V_{DRM}	600	V	
		ELR0223	0.3		
	ON-state	ELR1223	0.6		
	RMS current	ELR2223	$I_{T(RMS)}$	0.9	A
		ELR3223		1.2	
		ELR0223		3	
	Non-repetitive surge current* ³	ELR1223	I_{TSM}	6	A
		ELR2223		9	
		ELR3223		12	
	Isolation Voltage* ⁴	V_{iso}	5000	Vrms	
Storage Temperature	T_{STG}	-40 to 125	°C		
Operating Temperature	T_{OPR}	-40 to 85	°C		
Soldering Temperature* ⁵	T_{SOL}	260	°C		

Notes:

- *1 f =100Hz, Duty Cycle = 0.1%
- *2 Sine wave, 50 to 60Hz, $I_{FT}=0mA$.
- *3 f=60Hz, one cycle.
- *4 AC for 1 minute, R.H.= 40 ~ 60% R.H. In this test, pins 1, 2, 3, 4 are shorted together, and pins 5, 6, 7, 8 are shorted together.
- *5 For 10 seconds

Electro-Optical Characteristics (Ta=25°C)

	Parameter	Symbol	Condition	Min.	Typ.	Max.	Unit
Input	Forward Voltage	V_F	$I_F=20\text{mA}$	-	1.2	1.4	V
	Reverse Current	I_R	$V_R=6\text{V}$	-	-	10	μA
Output	Repetitive peak Off State Current	I_{DRM}	$I_F=0\text{mA}, V_{DRM}=600\text{V}$	-	-	100	μA
	On state Voltage	V_{TM}	$I_F = 10\text{mA}, I_{TM} = \text{MAX.}$	-	-	2.5	V
	Critical rate of rise of OFF state voltage	dV/dt	$V_{DRM}=600\text{V} \times 1/\sqrt{2}$	200	-	-	V/us
	Holding Current	I_H	-	-	-	25	mA
Transfer Characteristics	Minimum trigger Current	I_{FT}	$V_D=6\text{V}, R_L=100\Omega$	-	-	10	mA
	Turn On Time	T_{on}	$I_F = 20 \text{ mA}, V_D = 6\text{V}, R_L = 100\Omega$	-	-	10	μs
	Isolation Resistance	R_{I-O}	$V_{I-O}=500\text{V DC}, 40 \text{ to } 60\%RH$	-	5×10^{11}	-	Ω

EVERLIGHT

Typical Electro-Optical Characteristics Curves

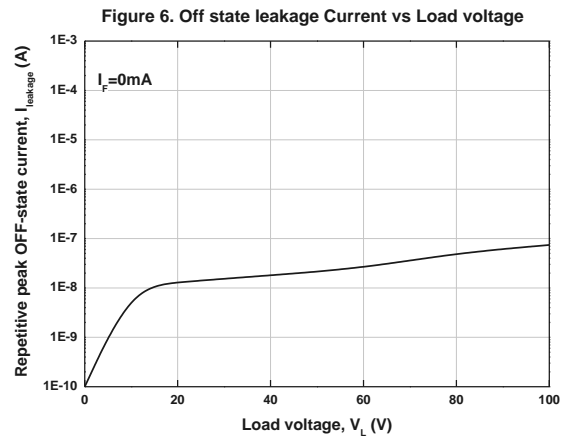
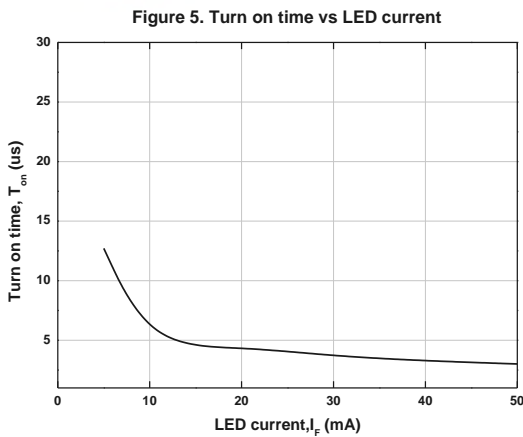
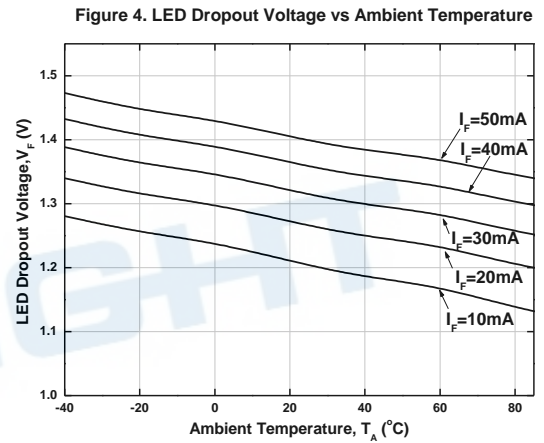
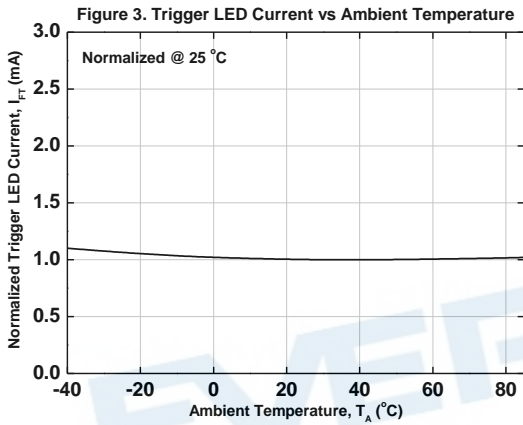
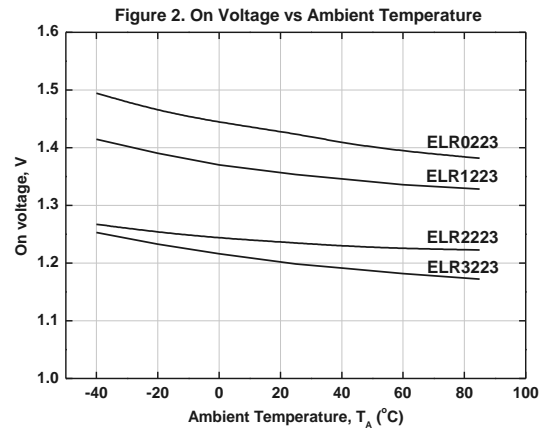
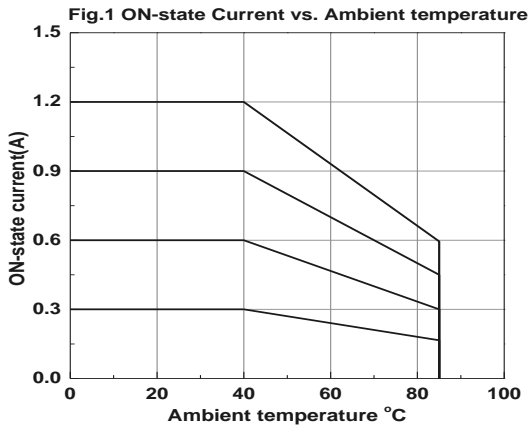

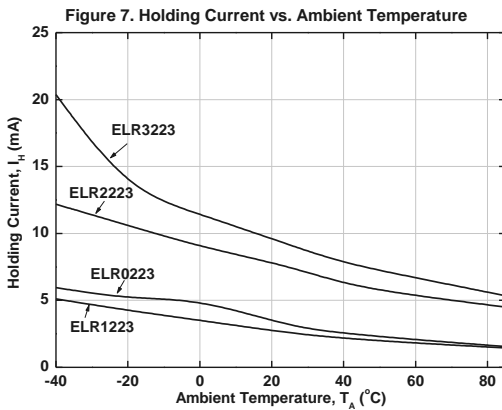

Order Information

Part Number

ELRX223Y(Z)-V

Note

- X = (0or 1 or 2 or 3) for ELX223 part no.
- Y = Lead form option (S, S1, M or none)
- Z = Tape and reel option (TA, TB or none).
- V = VDE (optional)

Option	Description	Packing quantity
None	Standard DIP-8	45 units per tube
M	Wide lead bend (0.4 inch spacing)	45 units per tube
S (TA)	Surface mount lead form + TA tape & reel option	1000 units per reel
S (TB)	Surface mount lead form + TB tape & reel option	1000 units per reel
S1 (TA)	Surface mount lead form (low profile) + TA tape & reel option	1000 units per reel
S1 (TB)	Surface mount lead form (low profile) + TB tape & reel option	1000 units per reel

Package Dimension
Standard DIP Type

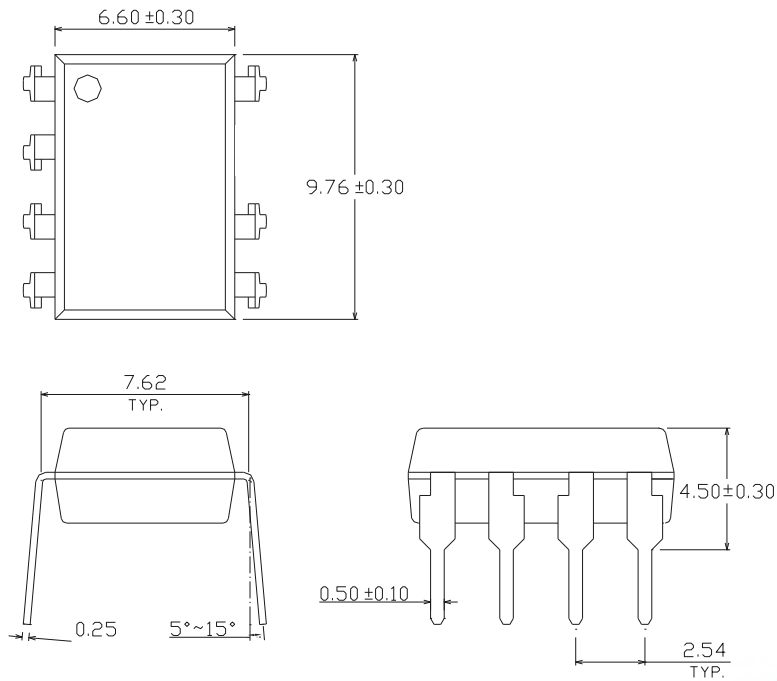

Option M Type

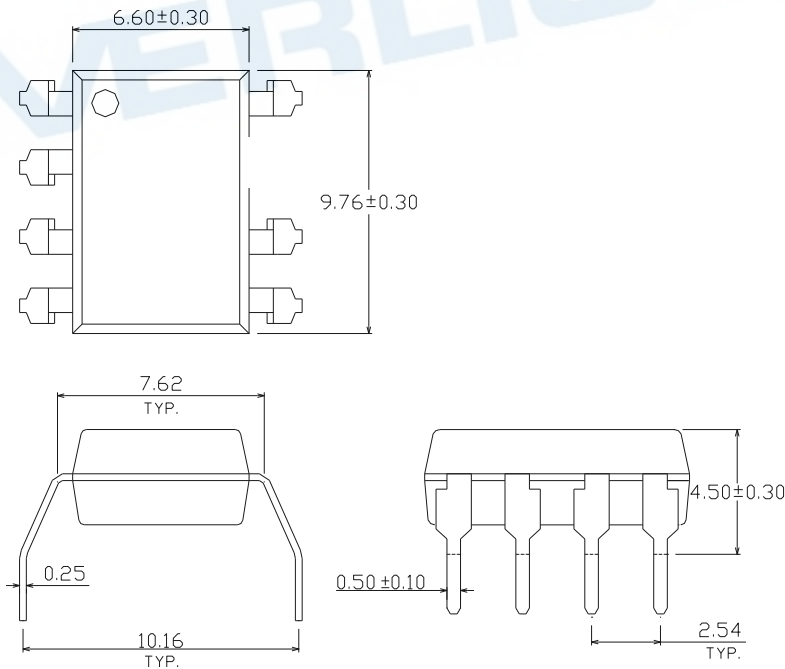

Option S Type

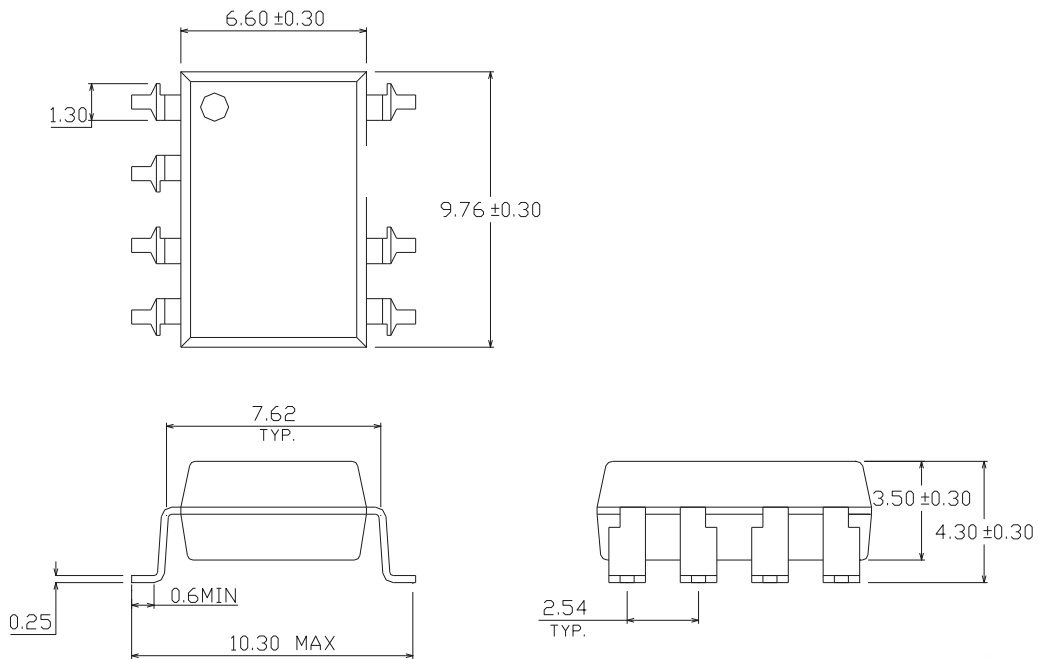

Option S1 Type

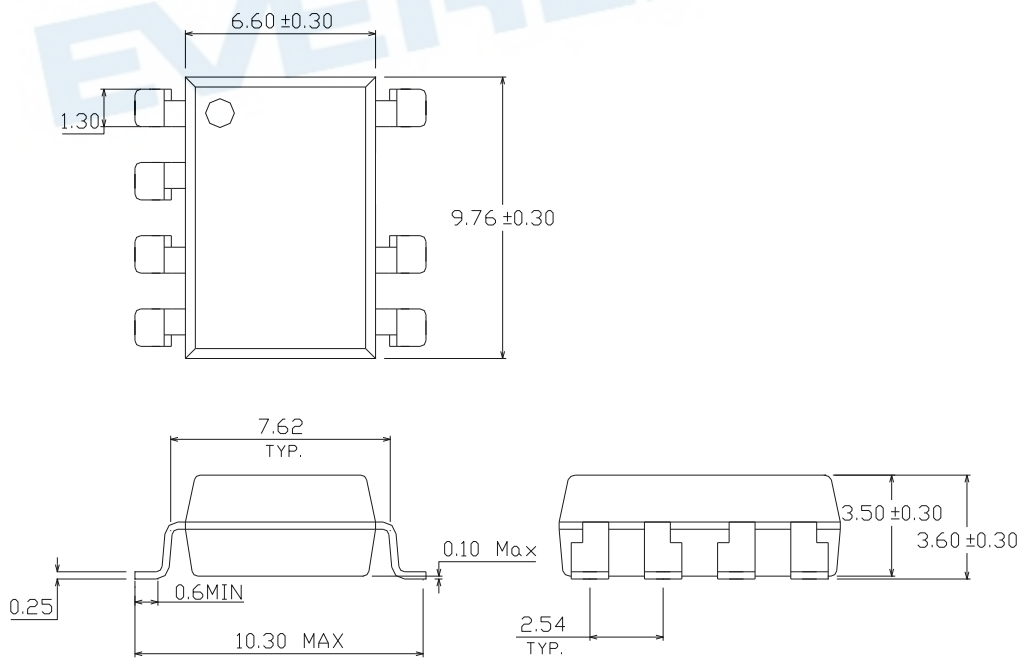

Recommended pad layout for surface mount leadform

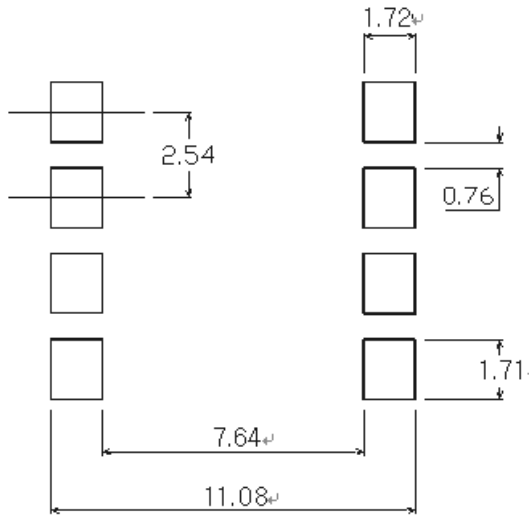

Device Marking

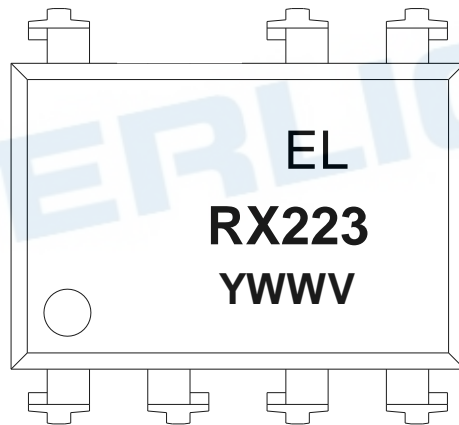

Notes

- EL denotes EVERLIGHT
- RX223 denotes Device Number(X = 0 or 1 or 2 or 3 for ELX223 part no.)
- Y denotes 1 digit Year code
- WW denotes 2 digit Week code
- V denotes VDE (optional)

Tape & Reel Packing Specifications

Option TA

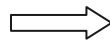
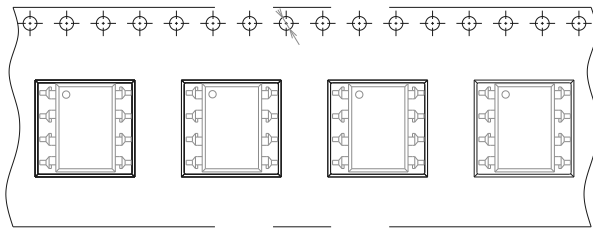

Direction of feed from reel

Option TB

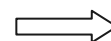
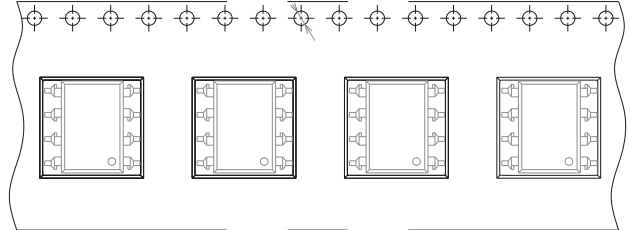

Direction of feed from reel

Tape dimension

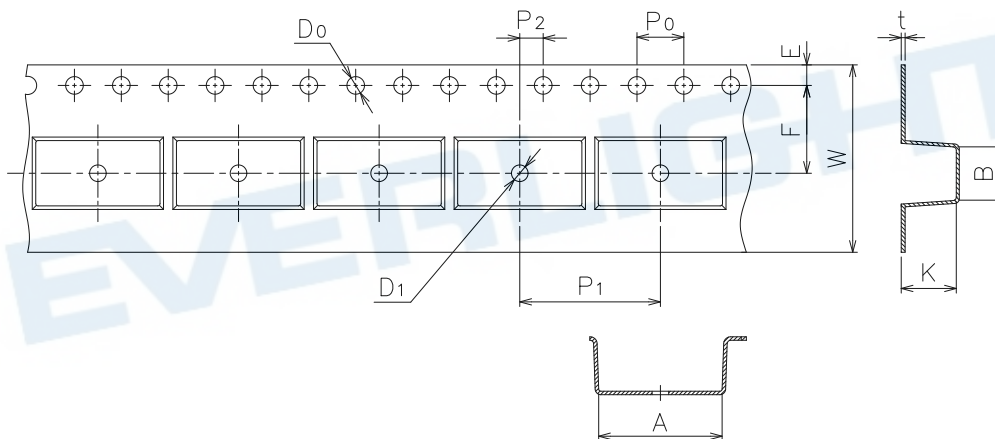

Dimension No.	A	B	Do	D1	E	F
Dimension(mm)	10.4±0.1	10.0±0.1	1.5+0.1/-0	1.5±0.25/-0	1.75±0.1	7.5±0.1
Dimension No.	Po	P1	P2	t	W	K
Dimension(mm)	4.0±0.1	12.0±0.1	2.0±0.05	0.4±0.05	16.0±0.3/	4.5±0.1

Precautions for Use

1. Soldering Condition

1.1 (A) Maximum Body Case Temperature Profile for evaluation of Reflow Profile

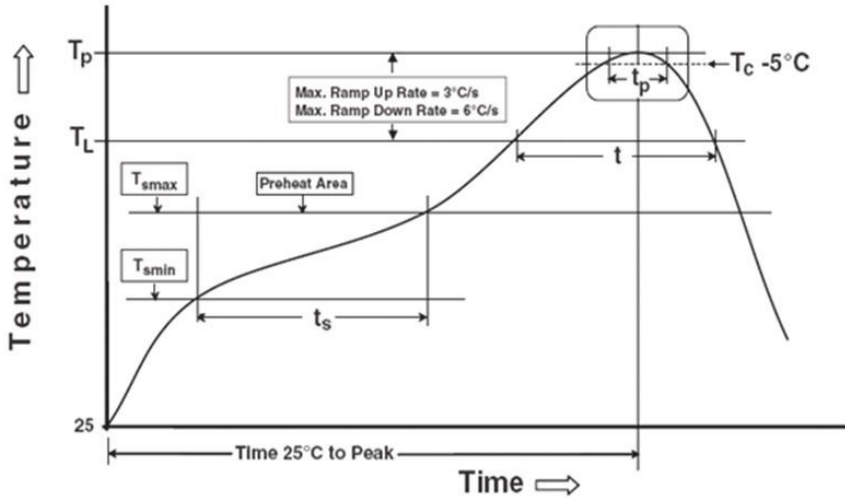

Note:

Reference: IPC/JEDEC J-STD-020D

Preheat

Temperature min (T_{smin})	150 °C
Temperature max (T_{smax})	200°C
Time (T_{smin} to T_{smax}) (t_s)	60-120 seconds
Average ramp-up rate (T_{smax} to T_p)	3 °C/second max

Other

Liquidus Temperature (T_L)	217 °C
Time above Liquidus Temperature (t_L)	60-100 sec
Peak Temperature (T_p)	260°C
Time within 5 °C of Actual Peak Temperature: $T_p - 5^\circ\text{C}$	30 s
Ramp- Down Rate from Peak Temperature	6°C /second max.
Time 25°C to peak temperature	8 minutes max.
Reflow times	3 times

DISCLAIMER

1. Above specification may be changed without notice. EVERLIGHT will reserve authority on material change for above specification.
2. The graphs shown in this datasheet are representing typical data only and do not show guaranteed values.
3. When using this product, please observe the absolute maximum ratings and the instructions for use outlined in these specification sheets. EVERLIGHT assumes no responsibility for any damage resulting from use of the product which does not comply with the absolute maximum ratings and the instructions included in these specification sheets.
4. These specification sheets include materials protected under copyright of EVERLIGHT. Reproduction in any form is prohibited without the specific consent of EVERLIGHT.
5. This product is not intended to be used for military, aircraft, automotive, medical, life sustaining or life saving applications or any other application which can result in human injury or death. Please contact authorized Everlight sales agent for special application request.
6. Statements regarding the suitability of products for certain types of applications are based on Everlight's knowledge of typical requirements that are often placed on Everlight products in generic applications. Such statements are not binding statements about the suitability of products for a particular application. It is the customer's responsibility to validate that a particular product with the properties described in the product specification is suitable for use in a particular application. Parameters provided in datasheets and/or specifications may vary in different applications and performance may vary over time. All operating parameters, including typical parameters, must be validated for each customer application by the customer's technical experts. Product specifications do not expand or otherwise modify Everlight's terms and conditions of purchase, including but not limited to the warranty expressed therein.