

## SMD ■ MID POWER LED

62-227ET/RK6D-MXXXXXXXXX2530U6/2T/EU

**Features**

- PLCC-2 Package
- Top view white LED
- High luminous flux output
- High current capability
- High Efficiency
- Wide viewing angle
- Pb-free
- RoHS compliant
- ANSI Binning
- High CRI

**Description**

The Everlight 62-227ET package has high efficacy, high CRI, low power consumption, wide viewing angle a compact form factor. These features make this package an ideal LED for all lighting application.

**Applications**

- Decorative and Entertainment Lighting
- Light pipe application
- Indicator and backlight in office and family equipment
- General use

**Product Number Explanation**

**62-227ET / R K 6 D – M XX XX XX XX XXXXU6/ 2T**

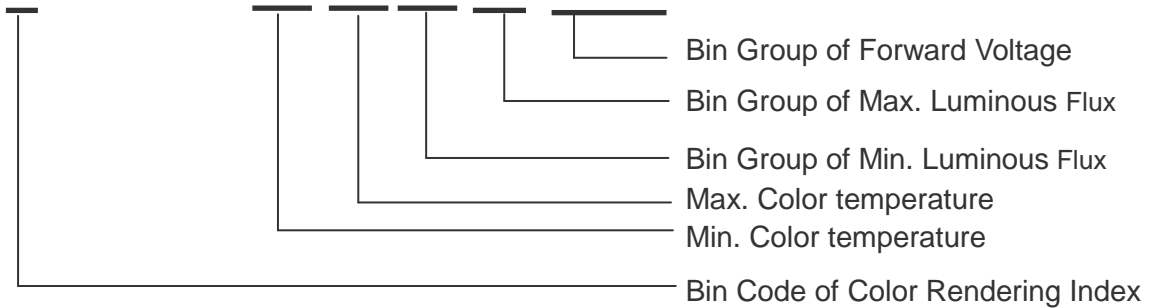

**Table of Color Rendering Index**

Symbol	Description
M	CRI(Min.) : 60
N	CRI(Min.) : 65
L	CRI(Min.) : 70
Q	CRI(Min.) : 75
K	CRI(Min.) : 80
H	CRI(Min.) : 90

Note:  
 Tolerance of Color Rendering Index: ±2

Example:

62-227ET/RK6D-M4040V7X72530U6/2T/EU

CRI	90(Min.)
CCT	4000K
Flux	27~37lm
V <sub>F</sub>	2.5~3.0V
I <sub>F</sub>	65mA

Mass Production List for CRI>90

Product	CRI Min. (1)	CCT(K)	Φ(lm) Min. (2)	Φ(lm) Max. (2)
62-227ET/RK6D-M2727V5X52530U6/2T/EU	90	2700K	25	35
62-227ET/RK6D-M3030V6X62530U6/2T/EU	90	3000K	26	36
62-227ET/RK6D-M3535V6X62530U6/2T/EU	90	3500K	26	36
62-227ET/RK6D-M4040V7X72530U6/2T/EU	90	4000K	27	37
62-227ET/RK6D-M5050V8X82530U6/2T/EU	90	5000K	28	38
62-227ET/RK6D-M5757V8X892530U6/2T/EU	90	5700K	28	38
62-227ET/RK6D-M6565V7X72530U6/2T/EU	90	6500K	27	37

Note:

1. Tolerance of Color Rendering Index:  $\pm 2$
2. Tolerance of Luminous flux:  $\pm 11\%$ .

EVERLIGHT

## Device Selection Guide

Chip Materials	Emitted Color	Resin Color
InGaN	Cool White	Water Clear
	Neutral White	
	Warm White	

## Absolute Maximum Ratings ( $T_{\text{Soldering}}=25^{\circ}\text{C}$ )

Parameter	Symbol	Rating	Unit
Forward Current	$I_F$	180	mA
Peak Forward Current (Duty 1/10 @10ms)	$I_{FP}$	300	mA
Power Dissipation	$P_d$	540	mW
Operating Temperature	$T_{opr}$	-40 ~ +85	$^{\circ}\text{C}$
Storage Temperature	$T_{stg}$	-40 ~ +100	$^{\circ}\text{C}$
Thermal Resistance (Junction / Soldering point)	$R_{th\ J-S}$	21	$^{\circ}\text{C/W}$
Junction Temperature	$T_j$	115	$^{\circ}\text{C}$
Soldering Temperature	$T_{sol}$	Reflow Soldering : 260 $^{\circ}\text{C}$ for 10 sec. Hand Soldering : 350 $^{\circ}\text{C}$ for 3 sec.	

## Electro-Optical Characteristics ( $T_{\text{Soldering}}=25^{\circ}\text{C}$ )

Parameter	Symbol	Min.	Typ.	Max.	Unit	Condition
Luminous Flux <sub>(1)</sub>	$\Phi$	25	-----	38	lm	$I_F=65\text{mA}$
Forward Voltage <sub>(2)</sub>	$V_F$	2.5	-----	3.0	V	$I_F=65\text{mA}$
Color Rendering Index <sub>(3)</sub>	Ra	90	-----	-----	-----	$I_F=65\text{mA}$
	R9	50	-----	-----	-----	$I_F=65\text{mA}$
Viewing Angle	$2\theta_{1/2}$	-----	120	-----	deg	$I_F=65\text{mA}$

Notes:

1. Tolerance of Luminous flux:  $\pm 11\%$ .
2. Tolerance of Forward Voltage:  $\pm 0.1\text{V}$ .
3. Tolerance of Color Rendering Index:  $\pm 2$

**Bin Range of Luminous Flux**

**2700K----62-227ET/RK6D-M2727V5X52530U6/2T/EU**

Bin Code	Min.	Max.	Unit	Condition
T1	25	27	lm	I <sub>F</sub> =65mA
T2	27	29		
T3	29	31		
T4	31	33		
T5	33	35		

**3000K----62-227ET/RK6D-M3030V6X62530U6/2T/EU**

Bin Code	Min.	Max.	Unit	Condition
T1	26	28	lm	I <sub>F</sub> =65mA
T2	28	30		
T3	30	32		
T4	32	34		
T5	34	36		

**3500K----62-227ET/RK6D-M3535V6X62530U6/2T/EU**

Bin Code	Min.	Max.	Unit	Condition
T1	26	28	lm	I <sub>F</sub> =65mA
T2	28	30		
T3	30	32		
T4	32	34		
T5	34	36		

**4000K----62-227ET/RK6D-M4040V7X72530U6/2T/EU**

Bin Code	Min.	Max.	Unit	Condition
T1	27	29	lm	I <sub>F</sub> =65mA
T2	29	31		
T3	31	33		
T4	33	35		
T5	35	37		

**5000K----62-227ET/RK6D-M5050V8X82530U6/2T/EU**

Bin Code	Min.	Max.	Unit	Condition
T1	28	30	lm	I <sub>F</sub> =65mA
T2	30	32		
T3	32	34		
T4	34	36		
T5	36	38		

**5700K----62-227ET/RK6D-M5757V8X82530U6/2T/EU**

Bin Code	Min.	Max.	Unit	Condition
T1	28	30	lm	I <sub>F</sub> =65mA
T2	30	32		
T3	32	34		
T4	34	36		
T5	36	38		

**6500K----62-227ET/RK6D-M6565V7X72530U6/2T/EU**

Bin Code	Min.	Max.	Unit	Condition
T1	27	29	lm	I <sub>F</sub> =65mA
T2	29	31		
T3	31	33		
T4	33	35		
T5	35	37		

Notes:

Tolerance of Luminous flux: ±11%

**Bin Range of Forward Voltage**

Group	Bin Code	Min.	Max.	Unit	Condition
2530	32	2.5	2.6	V	I <sub>F</sub> =65mA
	33	2.6	2.7		
	34	2.7	2.8		
	35	2.8	2.9		
	36	2.9	3.0		

Notes:

Tolerance of Forward Voltage : ±0.1V.

**Bin Code of Macadam 3 step**

Step	CCT	Cx	Cy	a	b	theta
3	2700	0.4583	0.4104	0.00810	0.00420	49.70
	3000	0.4345	0.4033	0.00834	0.00408	50.22
	3500	0.4080	0.3919	0.00927	0.00414	51.00
	4000	0.3827	0.3803	0.00939	0.00402	54.80
	5000	0.3451	0.3559	0.00822	0.00354	64.12
	5700	0.3293	0.3423	0.00747	0.00321	66.51
	6500	0.3131	0.3290	0.00669	0.00285	64.57

Step	CCT	Cx	Cy	a	b	theta
5	2700	0.4583	0.4104	0.01350	0.00700	49.70
	3000	0.4345	0.4033	0.01390	0.00680	50.22
	3500	0.4080	0.3919	0.01545	0.00690	51.00
	4000	0.3827	0.3803	0.01565	0.00670	54.80
	5000	0.3451	0.3559	0.01370	0.00590	64.12
	5700	0.3293	0.3423	0.01245	0.00535	66.51
	6500	0.3131	0.3290	0.01115	0.00475	64.57

The C.I.E. 1931 Chromaticity Diagram

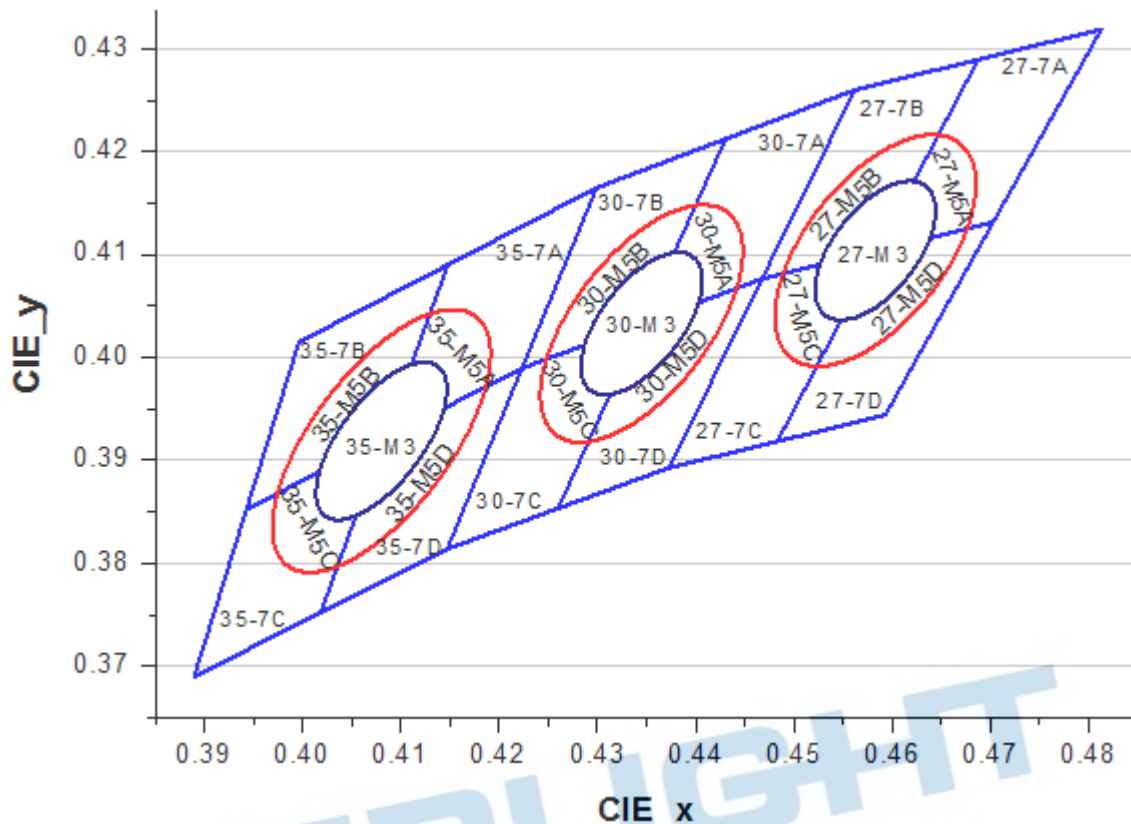

Bin Range of Chromaticity Coordinates

CCT	Bin Code	CIE_x	CIE_y	Bin Code	CIE_x	CIE_y	
2700K	27-7A	0.4813	0.4319	27-7D	0.4700	0.4126	
		0.4687	0.4289		0.4627	0.4109	
		0.4621	0.4169		0.4588	0.4041	
		0.4667	0.4180		0.4544	0.4030	
		0.4627	0.4109		0.4483	0.3919	
		0.4700	0.4126		0.4593	0.3944	
	Reference Range:2580K~2700K						
	27-7B	0.4687	0.4289	27-7C	0.4465	0.4071	
		0.4562	0.4260		0.4373	0.3893	
		0.4465	0.4071		0.4483	0.3919	
		0.4539	0.4088		0.4544	0.4030	
		0.4576	0.4158		0.4502	0.4020	
0.4621		0.4169	0.4539		0.4088		
Reference Range:2700K~2870K							



CCT	Bin Code	CIE_x	CIE_y	Bin Code	CIE_x	CIE_y	
3000K	30-7A	0.4562	0.4260	30-7D	0.4465	0.4071	
		0.4430	0.4212		0.4388	0.4043	
		0.4375	0.4096		0.4355	0.3977	
		0.4422	0.4113		0.4311	0.3962	
		0.4388	0.4043		0.4259	0.3853	
		0.4465	0.4071		0.4373	0.3893	
	Reference Range:2870K~3000K						
	30-7B	0.4430	0.4212	30-7C	0.4221	0.3984	
		0.4299	0.4165		0.4147	0.3814	
		0.4221	0.3984		0.4259	0.3853	
		0.4297	0.4011		0.4311	0.3962	
		0.4328	0.4079		0.4267	0.3946	
0.4375		0.4096	0.4297		0.4011		
Reference Range:3000K~3220K							

CCT	Bin Code	CIE_x	CIE_y	Bin Code	CIE_x	CIE_y	
3500K	35-7A	0.4299	0.4165	35-7D	0.4221	0.3984	
		0.4148	0.4090		0.4134	0.3943	
		0.4106	0.3981		0.4108	0.3878	
		0.4159	0.4007		0.4057	0.3853	
		0.4134	0.3943		0.4018	0.3752	
		0.4221	0.3984		0.4147	0.3814	
	Reference Range: 3220K~3500K						
	35-7B	0.4148	0.4090	35-7C	0.3943	0.3853	
		0.3996	0.4015		0.3889	0.3690	
		0.3943	0.3853		0.4018	0.3752	
		0.4029	0.3893		0.4057	0.3853	
		0.4051	0.3954		0.4006	0.3829	
0.4106		0.3981	0.4029		0.3893		
Reference Range:3360K~3550K							

The C.I.E. 1931 Chromaticity Diagram

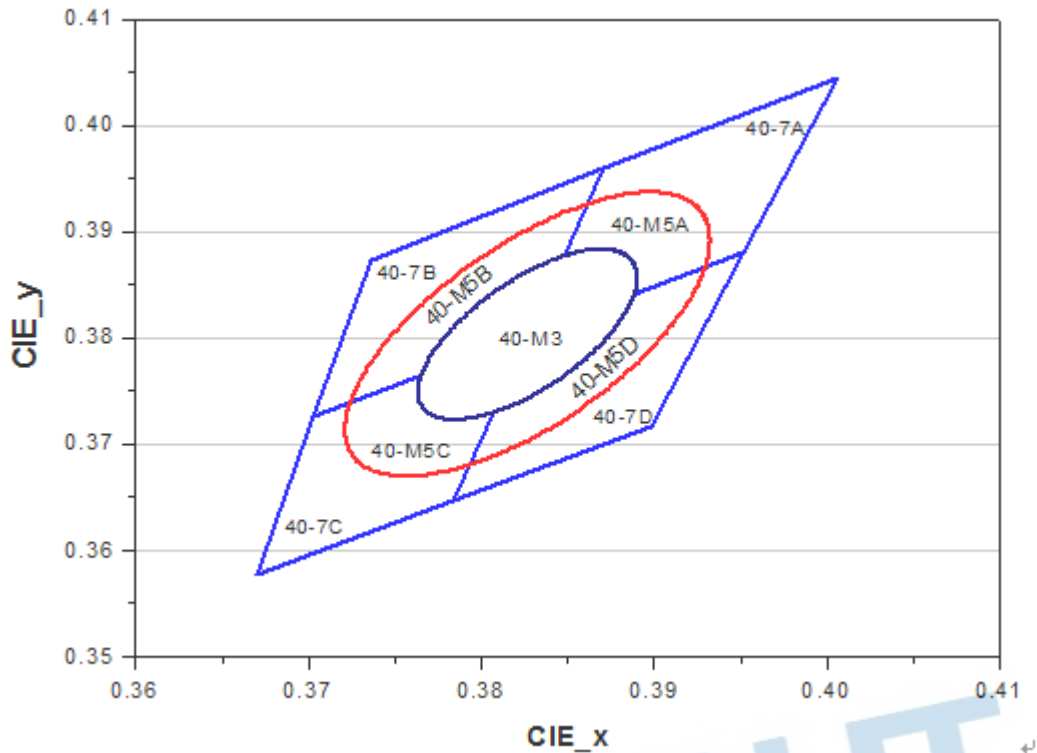

Bin Range of Chromaticity Coordinates

CCT	Bin Code	CIE_x	CIE_y	Bin Code	CIE_x	CIE_y	
4000K	40-7A	0.4006	0.4044	40-7D	0.3952	0.3880	
		0.3871	0.3959		0.3873	0.3831	
		0.3843	0.3858		0.3854	0.3768	
		0.3890	0.3887		0.3810	0.3741	
		0.3873	0.3831		0.3784	0.3647	
		0.3952	0.3880		0.3898	0.3716	
	Reference Range:3700K~3970K						
	40-7B	0.3871	0.3959	40-7C	0.3703	0.3726	
		0.3736	0.3874		0.3670	0.3578	
		0.3703	0.3726		0.3784	0.3647	
		0.3779	0.3773		0.3810	0.3741	
		0.3793	0.3828		0.3764	0.3713	
0.3843		0.3858	0.3779		0.3773		
Reference Range:3970K~4270K							

The C.I.E. 1931 Chromaticity Diagram

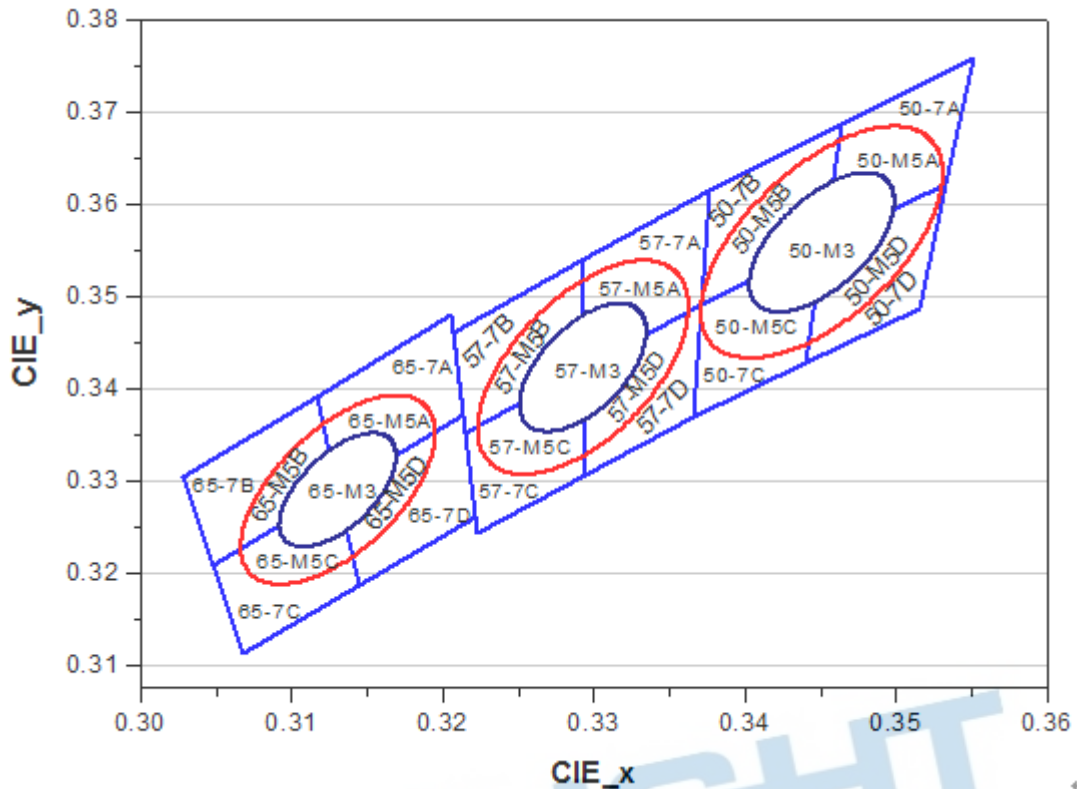

Bin Range of Chromaticity Coordinates

CCT	Bin Code	CIE_x	CIE_y	Bin Code	CIE_x	CIE_y	
5000K	50-7A	0.3551	0.3760	50-7D	0.3533	0.3624	
		0.3464	0.3688		0.3482	0.3583	
		0.3456	0.3604		0.3477	0.3530	
		0.3487	0.3629		0.3448	0.3507	
		0.3482	0.3583		0.3441	0.3428	
		0.3533	0.3624		0.3515	0.3487	
	Reference Range:4745K~5000K						
	50-7B	0.3464	0.3688	50-7C	0.3371	0.3493	
		0.3376	0.3616		0.3366	0.3369	
		0.3371	0.3493		0.3441	0.3428	
		0.3422	0.3533		0.3448	0.3507	
		0.3425	0.3579		0.3418	0.3483	
0.3456		0.3604	0.3422		0.3533		
Reference Range:5000K~5310K							

CCT	Bin Code	CIE_x	CIE_y	Bin Code	CIE_x	CIE_y	
5700K	57-7A	0.3376	0.3616	57-7D	0.3371	0.3493	
		0.3292	0.3539		0.3321	0.3447	
		0.3292	0.3464		0.3320	0.3401	
		0.3321	0.3490		0.3293	0.3377	
		0.3321	0.3447		0.3294	0.3306	
		0.3371	0.3493		0.3366	0.3369	
	Reference Range:5310K~5700K						
	57-7B	0.3292	0.3539	57-7C	0.3215	0.3353	
		0.3207	0.3462		0.3222	0.3243	
		0.3215	0.3353		0.3294	0.3306	
		0.3262	0.3395		0.3293	0.3377	
		0.3261	0.3436		0.3263	0.335	
		0.3292	0.3464		0.3262	0.3395	
	Reference Range:5700K~6020K						

CCT	Bin Code	CIE_x	CIE_y	Bin Code	CIE_x	CIE_y	
6500K	65-7A	0.3205	0.3481	65-7D	0.3213	0.3371	
		0.3117	0.3393		0.3161	0.3320	
		0.3125	0.3328		0.3166	0.3281	
		0.3157	0.3360		0.3136	0.3251	
		0.3161	0.3320		0.3145	0.3187	
		0.3213	0.3371		0.3221	0.3261	
	Reference Range:6020K~6500K						
	65-7B	0.3117	0.3393	65-7C	0.3048	0.3209	
		0.3028	0.3304		0.3068	0.3113	
		0.3048	0.3209		0.3145	0.3187	
		0.3100	0.3259		0.3136	0.3251	
		0.3093	0.3297		0.3106	0.3222	
		0.3125	0.3328		0.31	0.3259	
	Reference Range:6500K~7050K						

Notes:

1. The value is based on driving current by 65mA.
2. Tolerance of Chromaticity Coordinates:  $\pm 0.01$ .

Spectrum Distribution

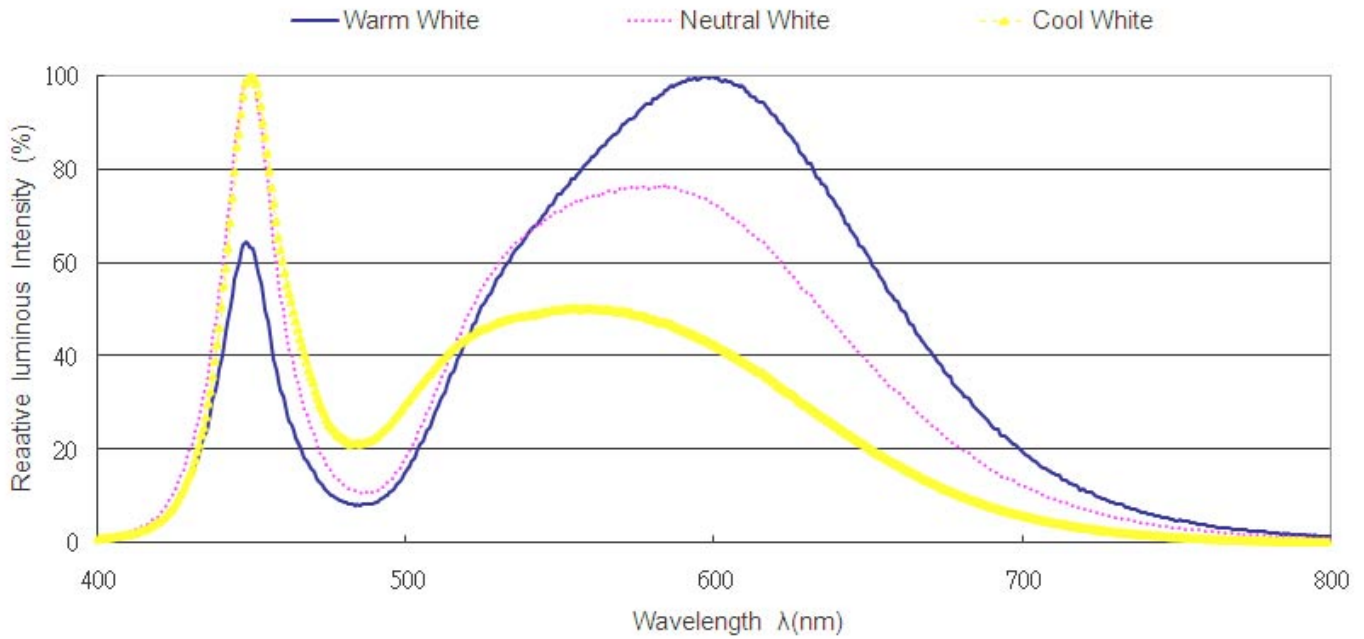

Typical Electro-Optical Characteristics Curves

Fig.1 – Forward Voltage Shift vs. Junction Temperature

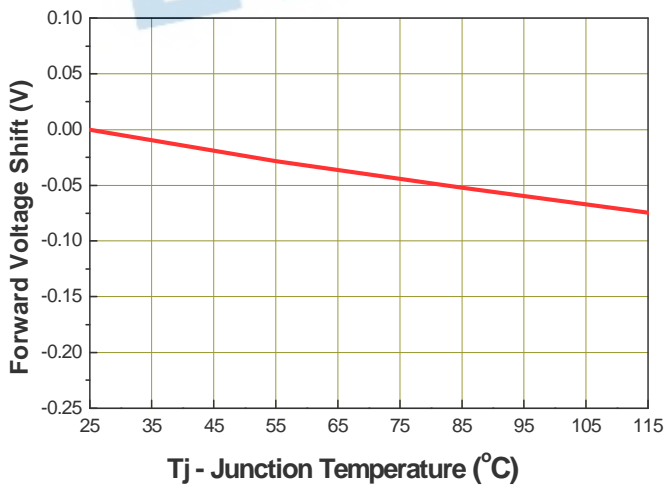
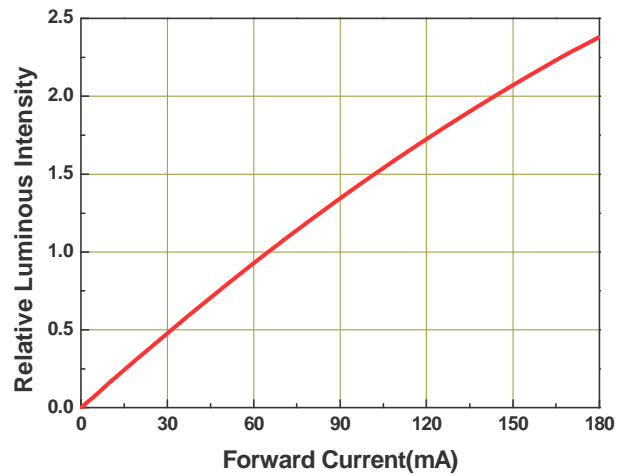

Fig.2 - Relative Luminous Intensity vs. Forward Current



Typical Electro-Optical Characteristics Curves

Fig.3 - Relative Luminous Intensity vs. Junction Temperature

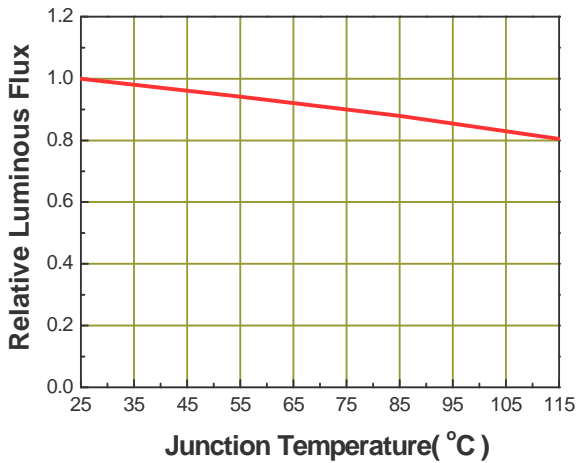

Fig.4 - Forward Current vs. Forward Voltage

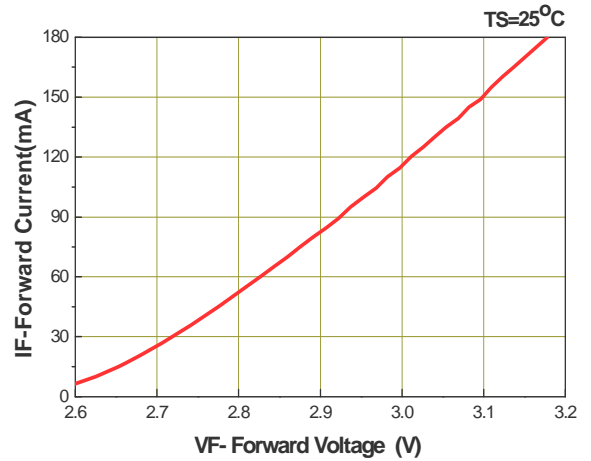

Fig.5 – Max. Driving Forward Current vs. Soldering Temperature

$R_{th\ j-s}=21\ ^\circ\text{C/W}$

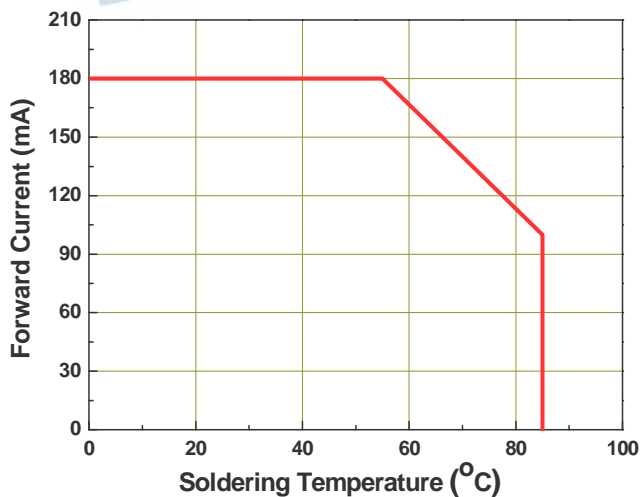
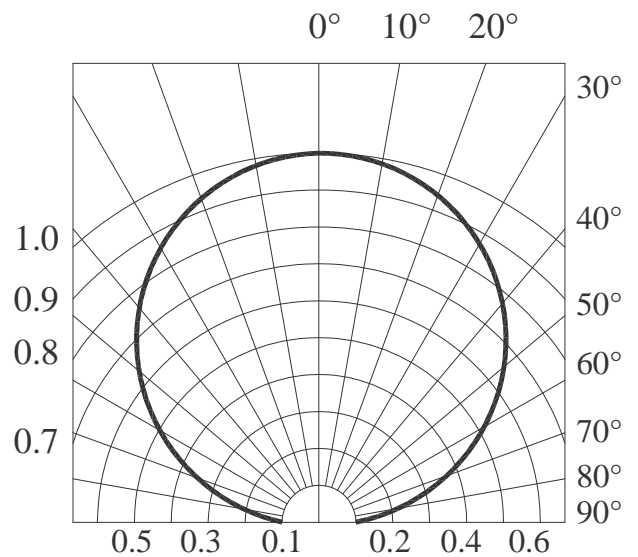
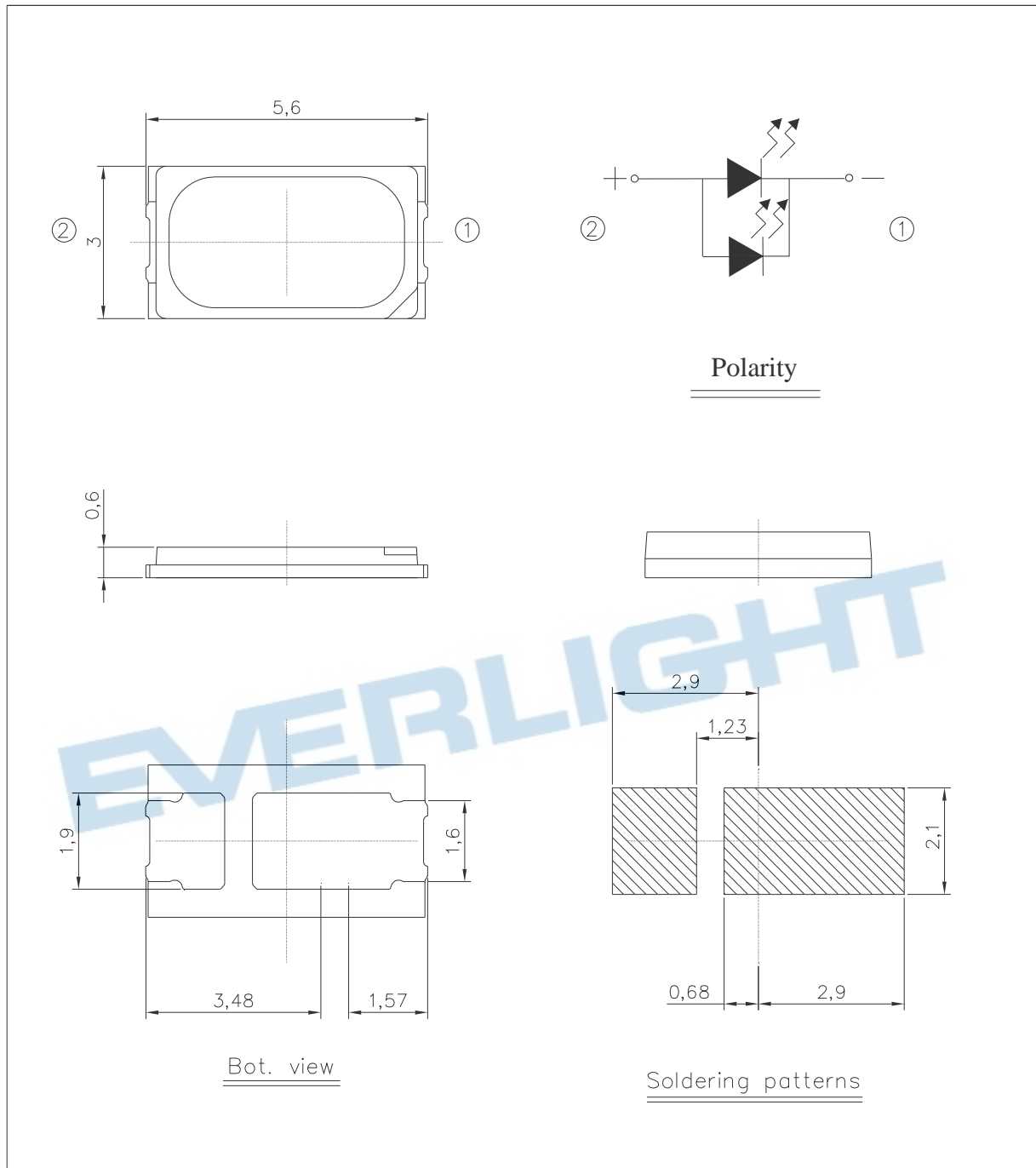

Fig.6 – Radiation Diagram



Package Dimension



Note:

Tolerance unless mentioned is  $\pm 0.1$ mm; Unit = mm

**Moisture Resistant Packing Materials**

**Label Explanation**

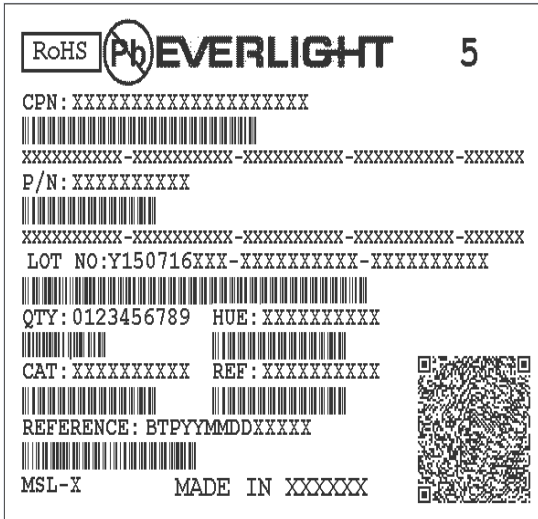

- CPN: Customer's Product Number
- P/N: Product Number
- QTY: Packing Quantity
- CAT: Luminous Intensity Rank
- HUE: Dom. Wavelength Rank
- REF: Forward Voltage Rank
- LOT No: Lot Number

**Reel Dimensions**

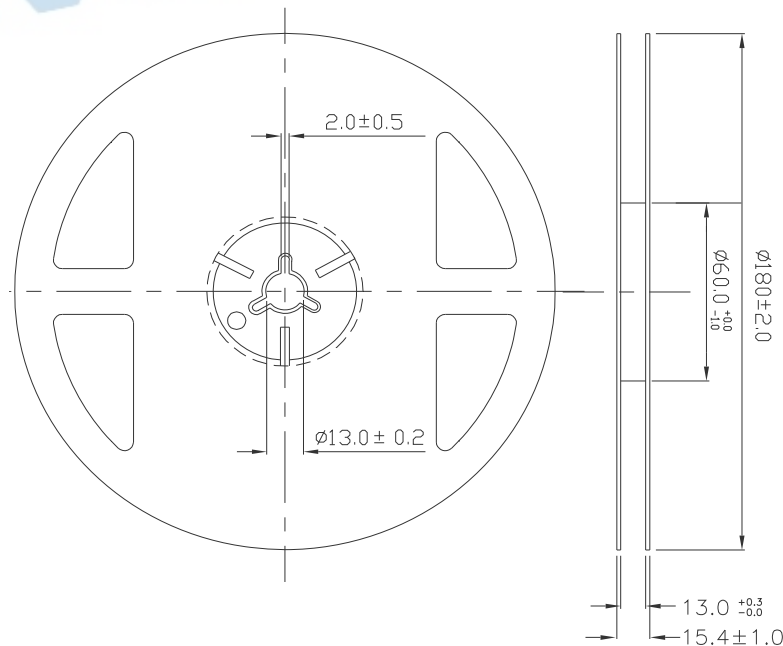

Note:  
 Tolerances unless mentioned  $\pm 0.1$ mm. Unit = mm



**Carrier Tape Dimensions: Loaded Quantity 2000 pcs. Per Reel**

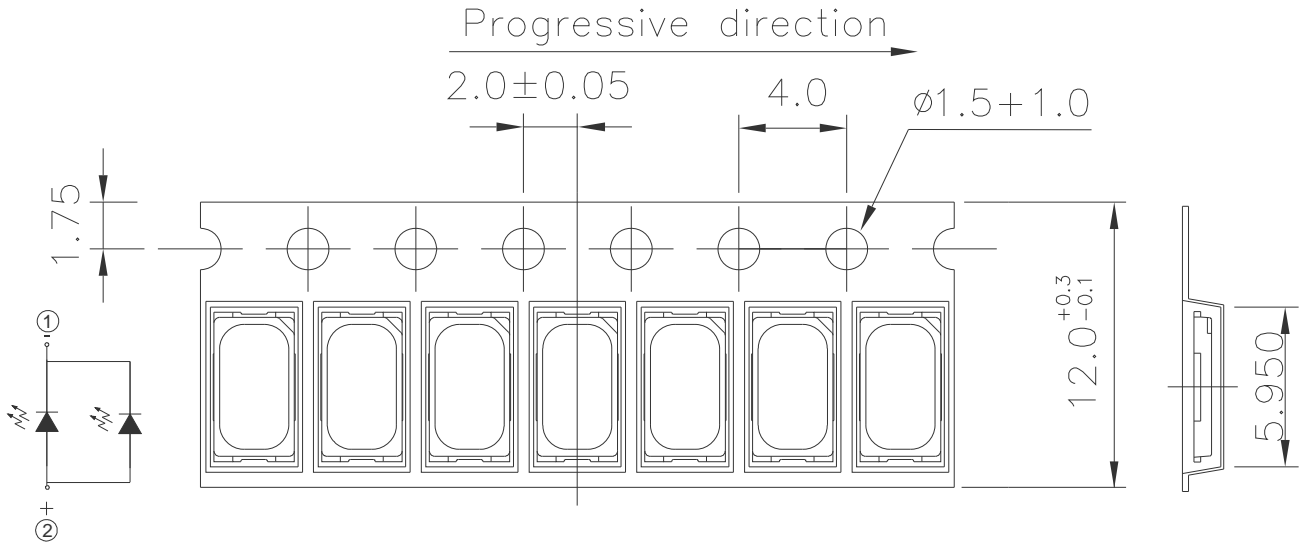

**Polarity**

Note:

Tolerance unless mentioned is  $\pm 0.1$  mm; Unit = mm

**Moisture Resistant Packing Process**

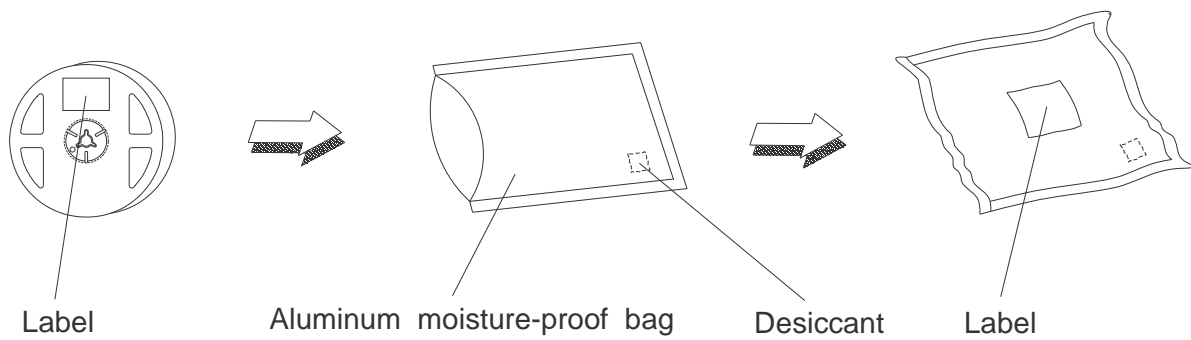

## Reliability Test Items and Conditions

The reliability of products shall be satisfied with items listed below.  
 Confidence level : 90%  
 LTPD : 10%

No.	Items	Test Condition	Test Hours/Cycles	Sample Size	Ac/Re
1	Reflow Soldering	Temp. : 260°C/10sec.	6 Min.	22 PCS.	0/1
2	Thermal Shock	H : +100°C 20min ∫ 10 sec L : -10°C 20min	200 Cycles	22 PCS.	0/1
3	Temperature Cycle	H : +100°C 30min ∫ 5 min L : -40°C 30min	200 Cycles	22 PCS.	0/1
4	High Temperature/Humidity Storage	Ta=85°C,85%RH	1000 Hrs.	22 PCS.	0/1
5	High Temperature/Humidity Operation	Ta=85°C,85%RH, I <sub>F</sub> = 100 mA	1000 Hrs.	22 PCS.	0/1
6	Low Temperature Storage	Ta=-40°C	1000 Hrs.	22 PCS.	0/1
7	High Temperature Storage	Ta=85°C	1000 Hrs.	22 PCS.	0/1
8	Low Temperature Operation Life	Ta=-40°C, I <sub>F</sub> = 150 mA	1000 Hrs.	22 PCS.	0/1
9	High Temperature Operation/ Life#1	Ta=25°C, I <sub>F</sub> = 150 mA	1000 Hrs.	22 PCS.	0/1
10	High Temperature Operation/ Life#2	Ta=55°C, I <sub>F</sub> =150 mA	1000 Hrs.	22 PCS.	0/1
11	High Temperature Operation/ Life#3	Ta=85°C, I <sub>F</sub> = 100 mA	1000 Hrs.	22 PCS.	0/1

## Precautions for Use

### 1. Over-current-proof

Customer must apply resistors for protection; otherwise slight voltage shift will cause big current change (Burn out will happen).

### 2. Storage

2.1 Do not open moisture proof bag before the products are ready to use.

2.2 Before opening the package: The LEDs should be kept at 30°C or less and 90%RH or less.

2.3 After opening the package: The LED's floor life is 168 Hrs under 30°C or less and 60% RH or less. If unused LEDs remain, it should be stored in moisture proof packages.

2.4 If the moisture absorbent material (silica gel) has faded away or the LEDs have exceeded the storage time, baking treatment should be performed using the following conditions.

Baking treatment: 60±5°C for 24 hours.

### 3. Soldering Condition

#### 3.1 Pb-free solder temperature profile

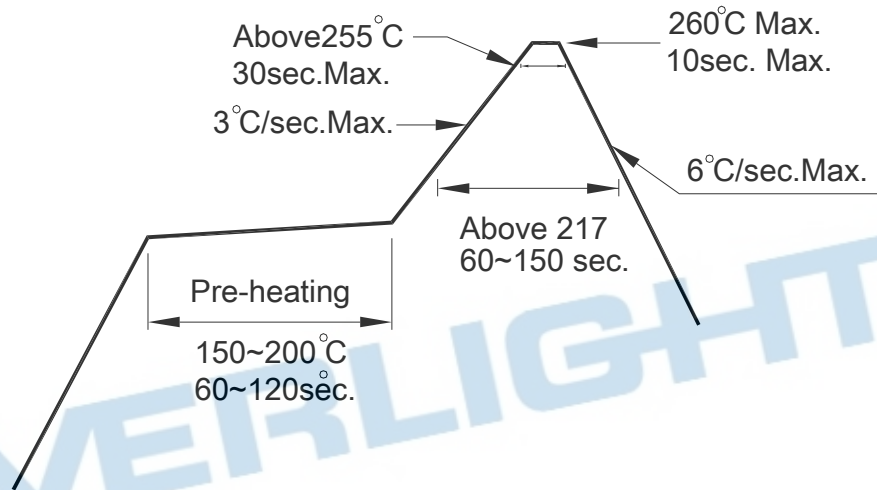

3.2 Reflow soldering should not be done more than two times.

3.3 When soldering, do not put stress on the LEDs during heating.

3.4 After soldering, do not warp the circuit board.

### 4. Soldering Iron

Each terminal is to go to the tip of soldering iron temperature less than 350°C for 3 seconds within once in less than the soldering iron capacity 25W. Leave two seconds and more intervals, and do soldering of each terminal. Be careful because the damage of the product is often started at the time of the hand solder.

### 5. Repairing

Repair should not be done after the LEDs have been soldered. When repairing is unavoidable, a double-head soldering iron should be used (as below figure). It should be confirmed beforehand whether the characteristics of the LEDs will or will not be damaged by repairing.

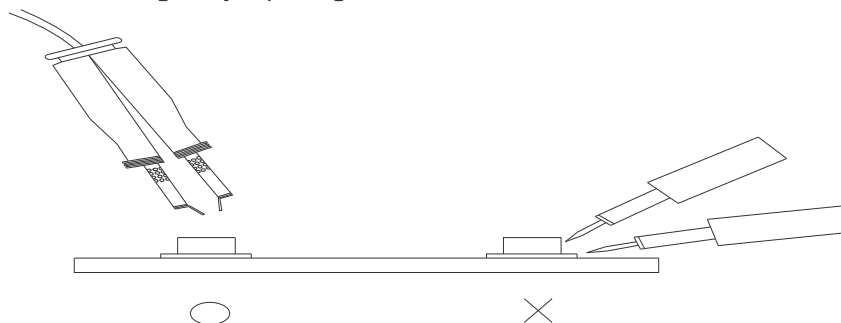

## DISCLAIMER

1. EVERLIGHT reserves the right(s) on the adjustment of product material mix for the specification.
2. The product meets EVERLIGHT published specification for a period of twelve (12) months from date of shipment.
3. The graphs shown in this datasheet are representing typical data only and do not show guaranteed values.
4. When using this product, please observe the absolute maximum ratings and the instructions for using outlined in these specification sheets. EVERLIGHT assumes no responsibility for any damage resulting from the use of the product which does not comply with the absolute maximum ratings and the instructions included in these specification sheets.
5. These specification sheets include materials protected under copyright of EVERLIGHT. Reproduction in any form is prohibited without obtaining EVERLIGHT's prior consent.
6. This product is not intended to be used for military, aircraft, automotive, medical,

EVERLIGHT