

SMD ■ MID POWER LED

62-227ET/KK6D-3MXXXXXXXXX2530U6/2T/EU



Features

- PLCC-2 Package
- Top view white LED
- High luminous flux output
- High current capability
- High Efficiency
- Wide viewing angle
- Pb-free
- RoHS compliant
- ANSI Binning

Description

The Everlight 62-227ET package has high efficacy, high CRI, low power consumption, wide viewing angle and a compact form factor. These features make this package an ideal LED for all lighting application.

Applications

- Decorative and Entertainment Lighting
- Light pipe application
- Indicator and backlight in office and family equipment
- General use

Product Number Explanation

62-227ET / KK 6 D – 3M XX XX XX XX XXXXU6/ 2T /EU

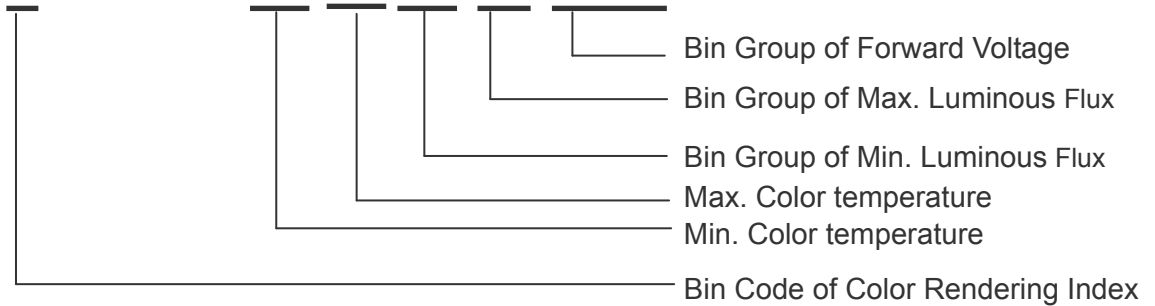

Table of Color Rendering Index

Symbol	Description
M	CRI(Min.) : 60
N	CRI(Min.) : 65
L	CRI(Min.) : 70
Q	CRI(Min.) : 75
K	CRI(Min.) : 80
H	CRI(Min.) : 90

Note:
 Tolerance of Color Rendering Index: ±2

Example:

62-227ET/KK6D-3M4040X4Y42530U6/2T/EU

CRI	80(Min.)
CCT	4000K
Flux	34~44lm
V _F	2.5~3.0V
I _F	65mA

Mass Production List for CRI>80

Product	CRI Min. (1)	CCT(K)	Φ(lm) Min. (2)	Φ(lm) Max. (2)
62-227ET/KK6D-3M2222V6X62530U6/2T/EU	80	2200K	26	36
62-227ET/KK6D-3M2727X1Y12530U6/2T/EU	80	2700K	31	41
62-227ET/KK6D-3M3030X2Y22530U6/2T/EU	80	3000K	32	42
62-227ET/KK6D-3M3535X2Y22530U6/2T/EU	80	3500K	32	42
62-227ET/KK6D-3M4040X4Y42530U6/2T/EU	80	4000K	34	44
62-227ET/KK6D-3M5050X5Y52530U6/2T/EU	80	5000K	35	45
62-227ET/KK6D-3M5757X5Y52530U6/2T/EU	80	5700K	35	45
62-227ET/KK6D-3M6565X4Y42530U6/2T/EU	80	6500K	34	44

Note:

1. Tolerance of Color Rendering Index: ± 2
2. Tolerance of Luminous flux: $\pm 11\%$.

EVERLIGHT

Device Selection Guide

Chip Materials	Emitted Color	Resin Color
InGaN	Cool White	Water Clear
	Neutral White	
	Warm White	

Absolute Maximum Ratings ($T_{\text{Soldering}}=25^{\circ}\text{C}$)

Parameter	Symbol	Rating	Unit
Forward Current	I_F	180	mA
Peak Forward Current (Duty 1/10 @10ms)	I_{FP}	300	mA
Power Dissipation	P_d	540	mW
Operating Temperature	T_{opr}	-40 ~ +85	$^{\circ}\text{C}$
Storage Temperature	T_{stg}	-40 ~ +100	$^{\circ}\text{C}$
Thermal Resistance (Junction / Soldering point)	$R_{th\ J-S}$	11	$^{\circ}\text{C/W}$
Junction Temperature	T_j	115	$^{\circ}\text{C}$
Soldering Temperature	T_{sol}	Reflow Soldering : 260 $^{\circ}\text{C}$ for 10 sec. Hand Soldering : 350 $^{\circ}\text{C}$ for 3 sec.	

Electro-Optical Characteristics ($T_{\text{Soldering}}=25^{\circ}\text{C}$)

Parameter	Symbol	Min.	Typ.	Max.	Unit	Condition
Luminous Flux ₍₁₎	Φ	26	-----	45	lm	$I_F=65\text{mA}$
Forward Voltage ₍₂₎	V_F	2.5	-----	3.0	V	$I_F=65\text{mA}$
Color Rendering Index ₍₃₎	Ra	80	-----	-----	-----	$I_F=65\text{mA}$
Viewing Angle	$2\theta_{1/2}$	-----	120	-----	deg	$I_F=65\text{mA}$

Notes:

1. Tolerance of Luminous flux: $\pm 11\%$.
2. Tolerance of Forward Voltage: $\pm 0.1\text{V}$.
3. Tolerance of Color Rendering Index: ± 2

Bin Range of Luminous Flux

2200K----62-227ET/KK6D-3M2222V6X62530U6/2T

Bin Code	Min.	Max.	Unit	Condition
T1	26	28	lm	I _F =65mA
T2	28	30		
T3	30	32		

2700K----62-227ET/KK6D-3M2727X1Y12530U6/2T

Bin Code	Min.	Max.	Unit	Condition
T1	31	33	lm	I _F =65mA
T2	33	35		
T3	35	37		

3000K----62-227ET/KK6D-3M3030X2Y22530U6/2T

Bin Code	Min.	Max.	Unit	Condition
T1	32	34	lm	I _F =65mA
T2	34	36		
T3	36	38		

3500K----62-227ET/KK6D-3M3535X2Y22530U6/2T

Bin Code	Min.	Max.	Unit	Condition
T1	32	34	lm	I _F =65mA
T2	34	36		
T3	36	38		

4000K----62-227ET/KK6D-3M4040X4Y42530U6/2T

Bin Code	Min.	Max.	Unit	Condition
T1	34	36	lm	I _F =65mA
T2	36	38		
T3	38	40		

5000K----62-227ET/KK6D-3M5050X5Y52530U6/2T

Bin Code	Min.	Max.	Unit	Condition
T1	35	37	lm	I _F =65mA
T2	37	39		
T3	39	41		

5700K----62-227ET/KK6D-3M5757X5Y52530U6/2T

Bin Code	Min.	Max.	Unit	Condition
T1	35	37	lm	I _F =65mA
T2	37	39		
T3	39	41		

6500K----62-227ET/KK6D-3M6565X4Y42530U6/2T

Bin Code	Min.	Max.	Unit	Condition
T1	34	36	lm	I _F =65mA
T2	36	38		
T3	38	40		

Notes:
 Tolerance of Luminous flux: ±11%

Bin Range of Forward Voltage

Group	Bin Code	Min.	Max.	Unit	Condition
2530	32	2.5	2.6	V	I _F =65mA
	33	2.6	2.7		
	34	2.7	2.8		
	35	2.8	2.9		
	36	2.9	3.0		

Notes:
 Tolerance of Forward Voltage : ±0.1V.

Bin Code of Macadam 3 step

Step	CCT	Cx	Cy	a	b	theta
3	2200	0.5059	0.4139	0.00927	0.00435	40.00
	2700	0.4583	0.4104	0.00810	0.00420	49.70
	3000	0.4345	0.4033	0.00834	0.00408	50.22
	3500	0.4080	0.3919	0.00927	0.00414	51.00
	4000	0.3827	0.3803	0.00939	0.00402	54.80
	5000	0.3451	0.3559	0.00822	0.00354	64.12
	5700	0.3293	0.3423	0.00747	0.00321	66.51
	6500	0.3131	0.3290	0.00669	0.00285	64.57

EVERLIGHT

The C.I.E. 1931 Chromaticity Diagram

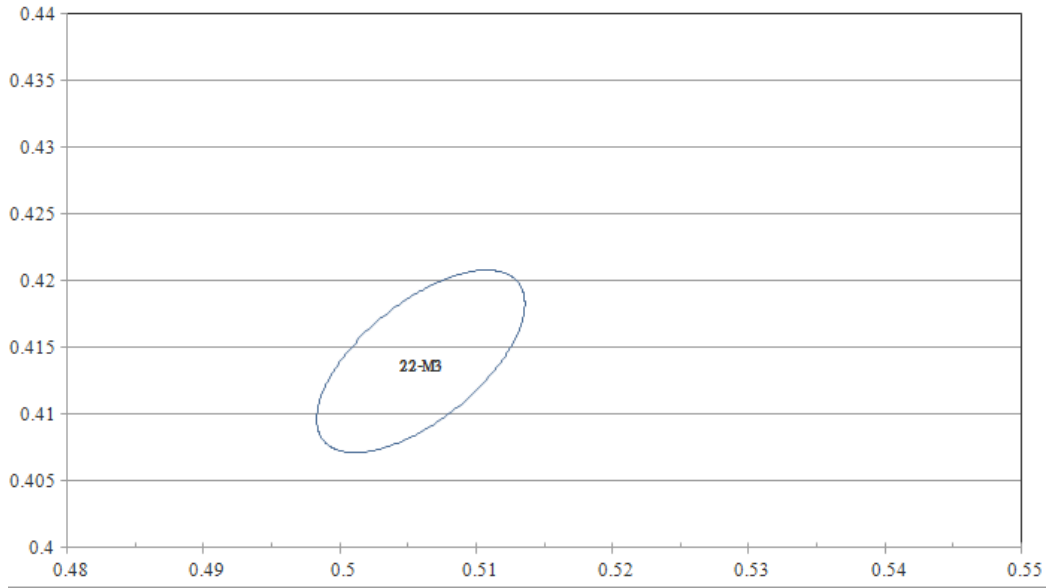

The C.I.E. 1931 Chromaticity Diagram

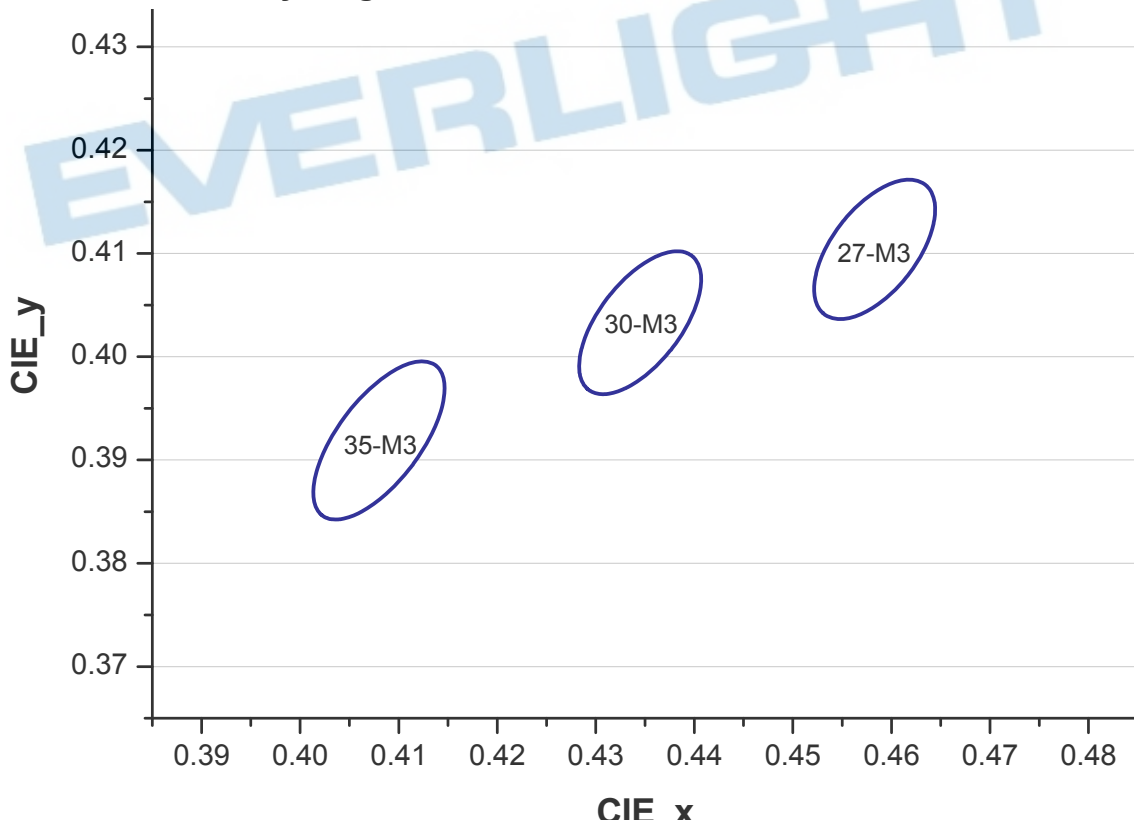

The C.I.E. 1931 Chromaticity Diagram

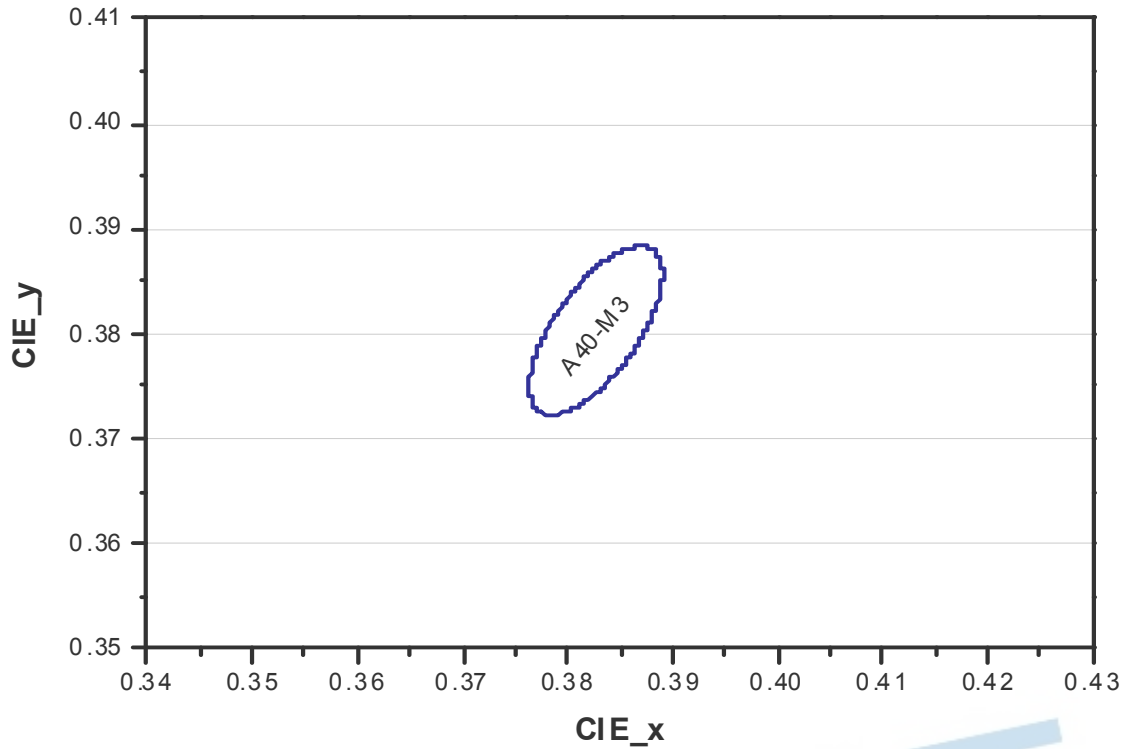

The C.I.E. 1931 Chromaticity Diagram

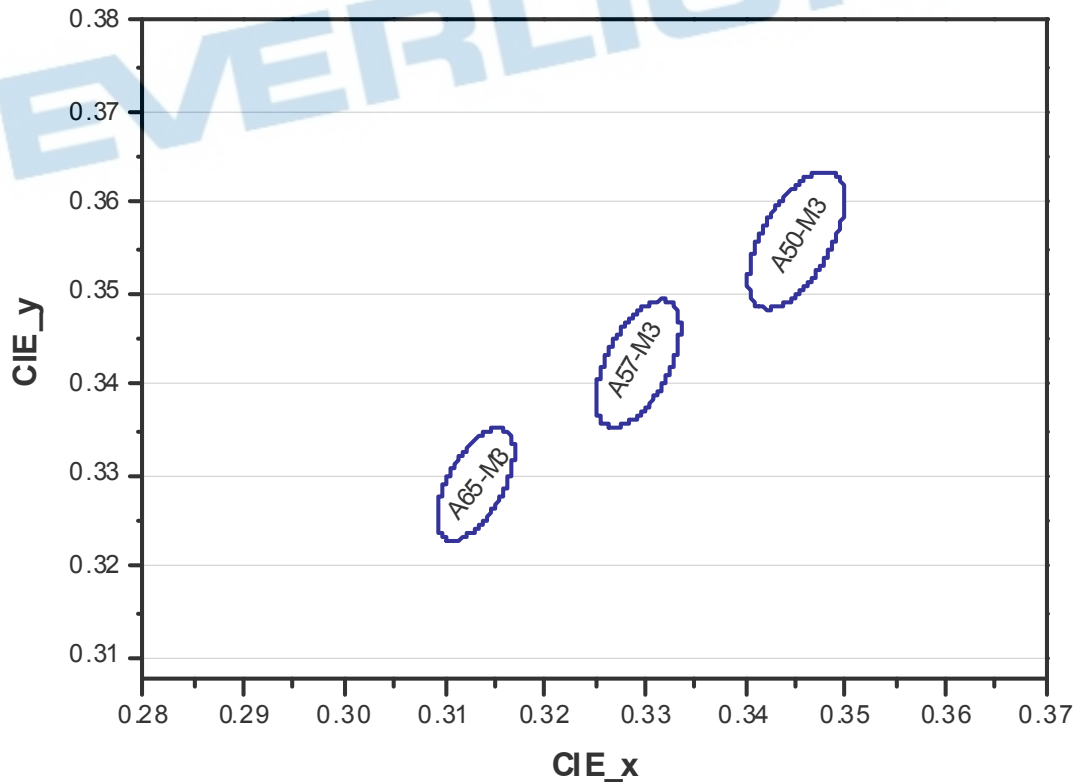

Notes:

1. The value is based on driving current by 65mA.
2. Tolerance of Chromaticity Coordinates: ± 0.01 .

Spectrum Distribution

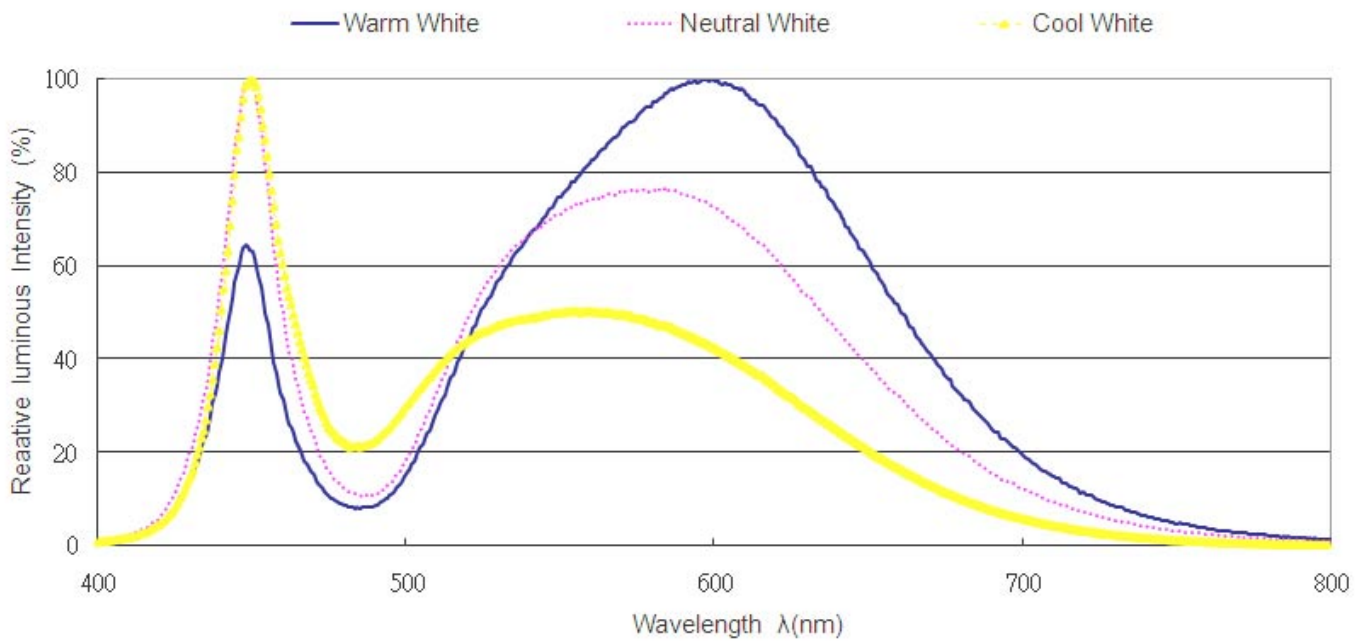

Typical Electro-Optical Characteristics Curves

Fig.1 – Forward Voltage Shift vs. Junction Temperature

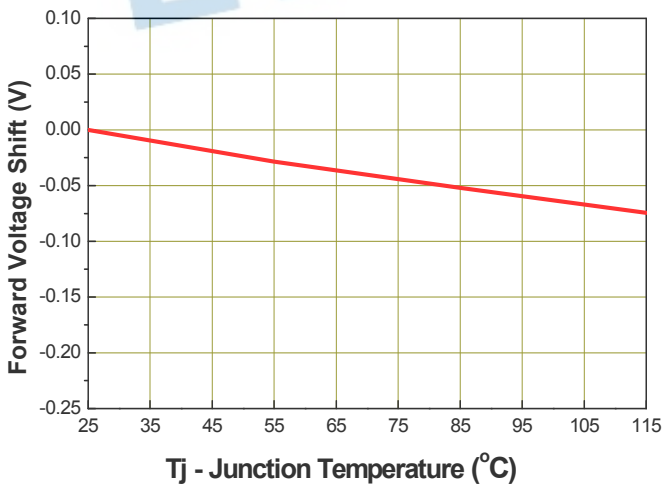
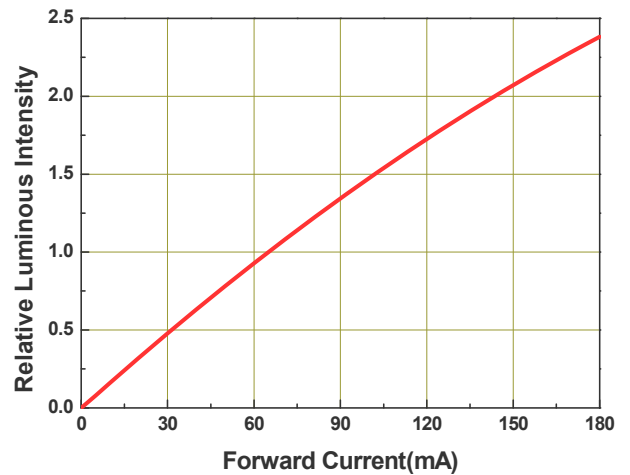

Fig.2 - Relative Luminous Intensity vs. Forward Current



Typical Electro-Optical Characteristics Curves

Fig.3 - Relative Luminous Intensity vs. Junction Temperature

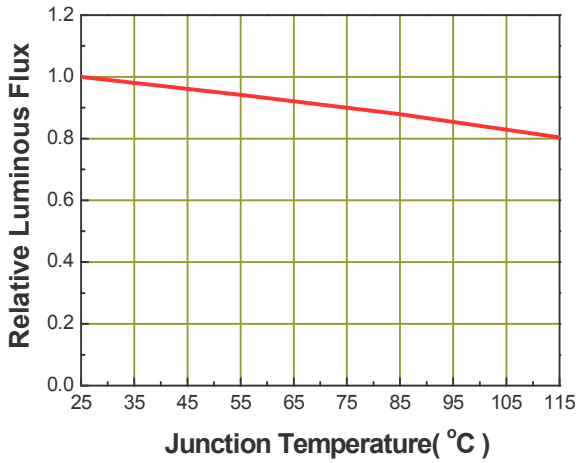

Fig.4 - Forward Current vs. Forward Voltage

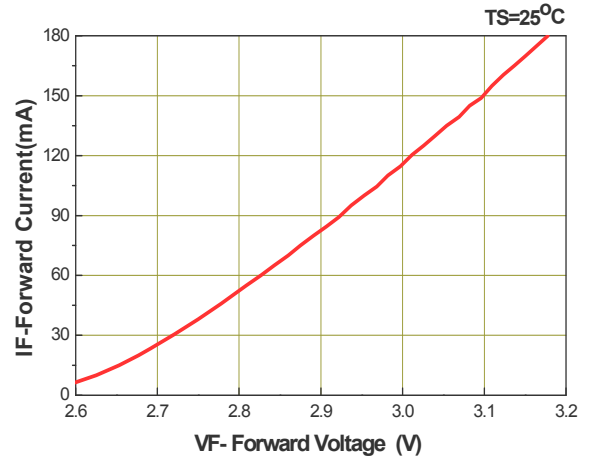

Fig.5 – Max. Driving Forward Current vs. Soldering Temperature

$R_{th\ j-s}=11\ ^\circ\text{C/W}$

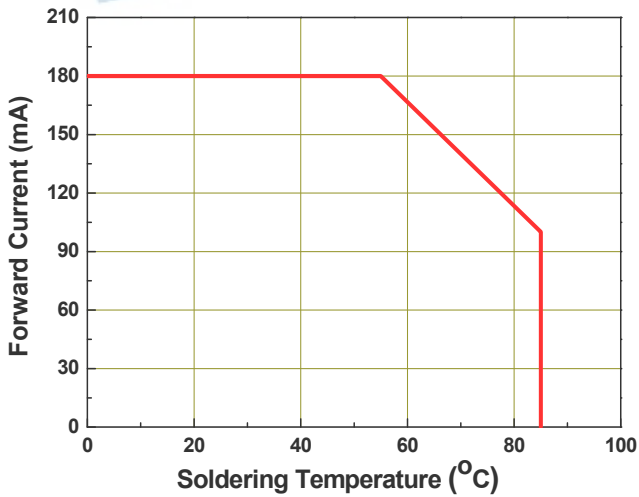
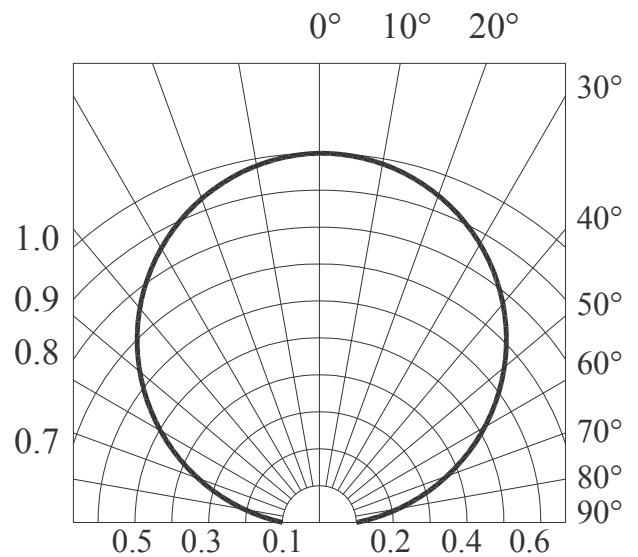
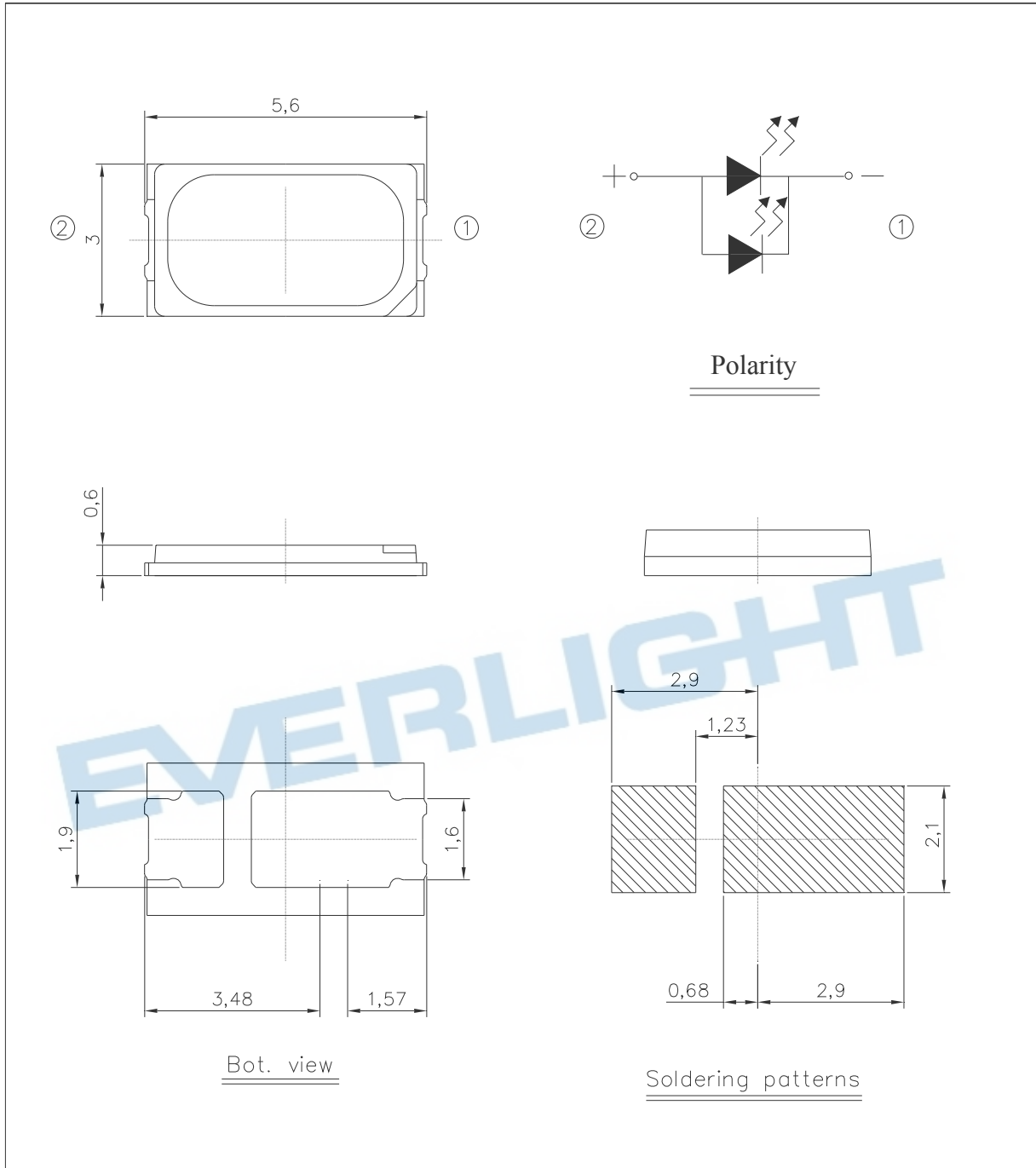

Fig.6 – Radiation Diagram



Package Dimension



Note:

Tolerance unless mentioned is $\pm 0.1\text{mm}$; Unit = mm

Moisture Resistant Packing Materials

Label Explanation

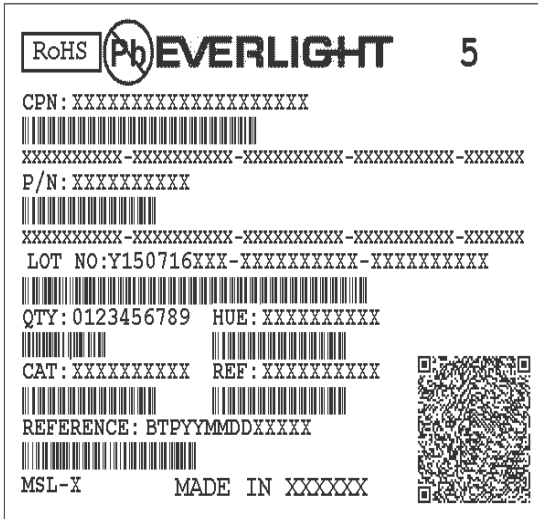

- CPN: Customer's Product Number
- P/N: Product Number
- QTY: Packing Quantity
- CAT: Luminous Intensity Rank
- HUE: Dom. Wavelength Rank
- REF: Forward Voltage Rank
- LOT No: Lot Number

Reel Dimensions

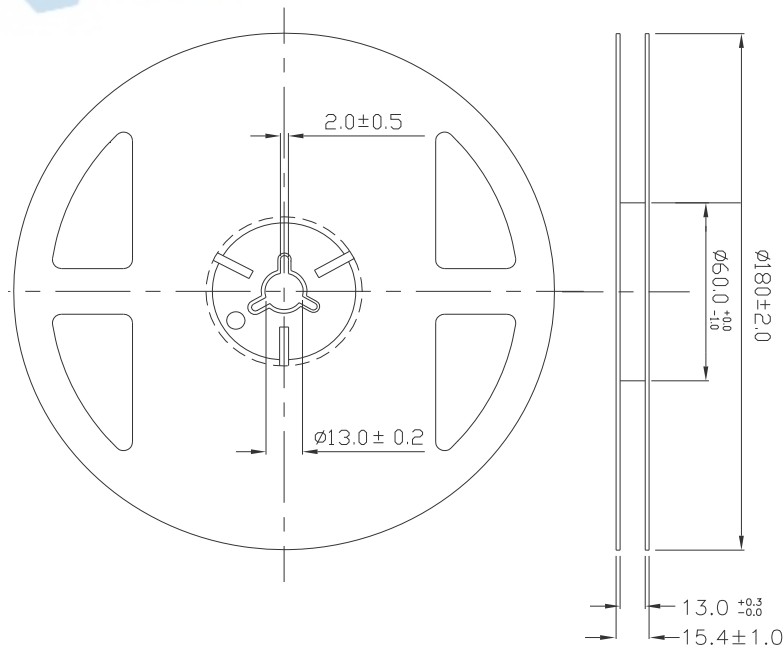

Note:
 Tolerances unless mentioned ±0.1mm. Unit = mm

Carrier Tape Dimensions: Loaded Quantity 2000 pcs. Per Reel

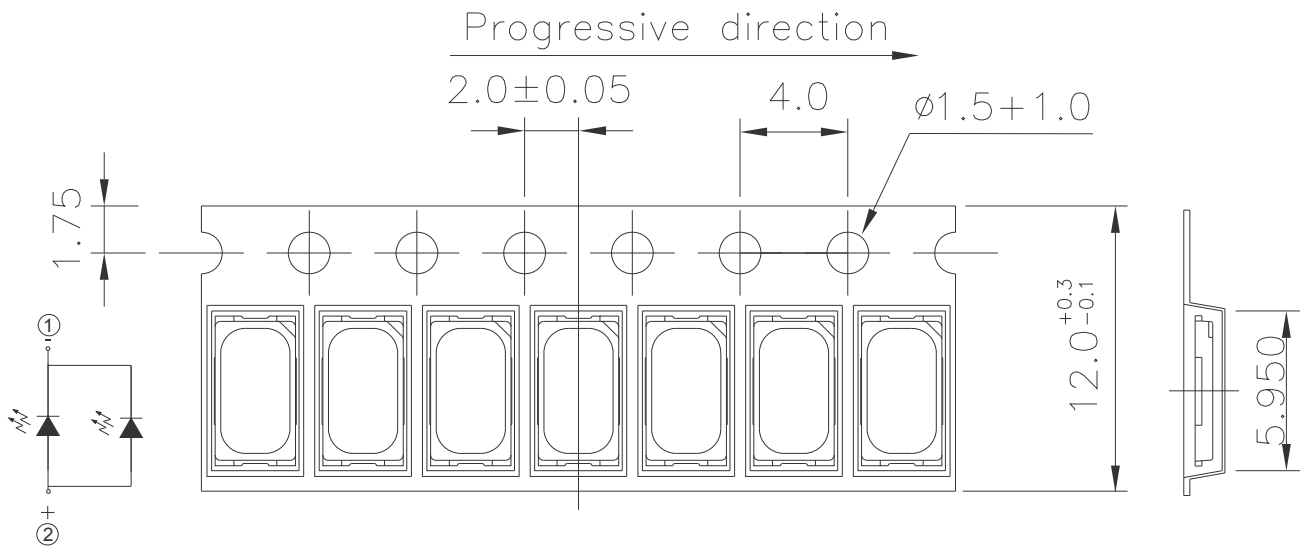

Polarity

Note:

Tolerance unless mentioned is ± 0.1 mm; Unit = mm

Moisture Resistant Packing Process

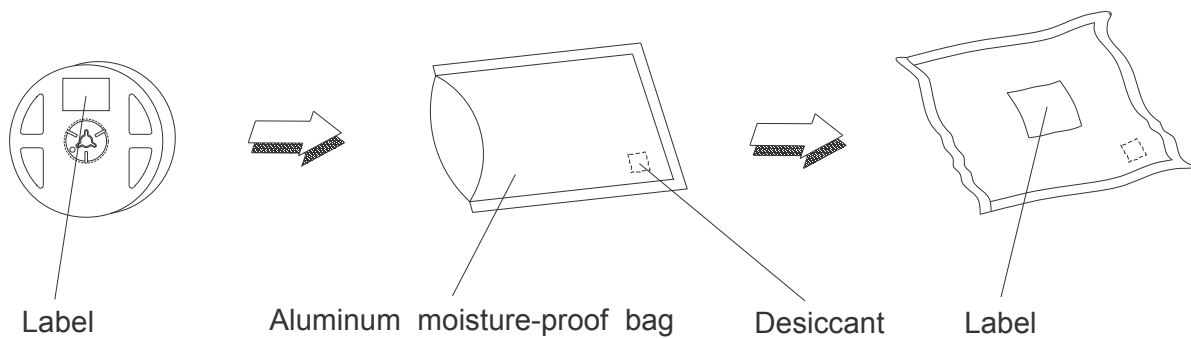

Reliability Test Items and Conditions

The reliability of products shall be satisfied with items listed below.
 Confidence level : 90%
 LTPD : 10%

No.	Items	Test Condition	Test Hours/Cycles	Sample Size	Ac/Re
1	Reflow Soldering	Temp. : 260°C/10sec.	6 Min.	22 PCS.	0/1
2	Thermal Shock	H : +100°C 20min ∫ 10 sec L : -10°C 20min	200 Cycles	22 PCS.	0/1
3	Temperature Cycle	H : +100°C 30min ∫ 5 min L : -40°C 30min	200 Cycles	22 PCS.	0/1
4	High Temperature/Humidity Storage	Ta=85°C,85%RH	1000 Hrs.	22 PCS.	0/1
5	High Temperature/Humidity Operation	Ta=85°C,85%RH, I _F = 100 mA	1000 Hrs.	22 PCS.	0/1
6	Low Temperature Storage	Ta=-40°C	1000 Hrs.	22 PCS.	0/1
7	High Temperature Storage	Ta=85°C	1000 Hrs.	22 PCS.	0/1
8	Low Temperature Operation Life	Ta=-40°C, I _F = 150 mA	1000 Hrs.	22 PCS.	0/1
9	High Temperature Operation/ Life#1	Ta=25°C, I _F = 150 mA	1000 Hrs.	22 PCS.	0/1
10	High Temperature Operation/ Life#2	Ta=55°C, I _F =150 mA	1000 Hrs.	22 PCS.	0/1
11	High Temperature Operation/ Life#3	Ta=85°C, I _F = 100 mA	1000 Hrs.	22 PCS.	0/1

Precautions for Use

1. Over-current-proof

Customer must apply resistors for protection; otherwise slight voltage shift will cause big current change (Burn out will happen).

2. Storage

2.1 Do not open moisture proof bag before the products are ready to use.

2.2 Before opening the package: The LEDs should be kept at 30°C or less and 90%RH or less.

2.3 After opening the package: The LED's floor life is 168 Hrs under 30°C or less and 60% RH or less. If unused LEDs remain, it should be stored in moisture proof packages.

2.4 If the moisture absorbent material (silica gel) has faded away or the LEDs have exceeded the storage time, baking treatment should be performed using the following conditions.

Baking treatment: 60±5°C for 24 hours.

3. Soldering Condition

3.1 Pb-free solder temperature profile

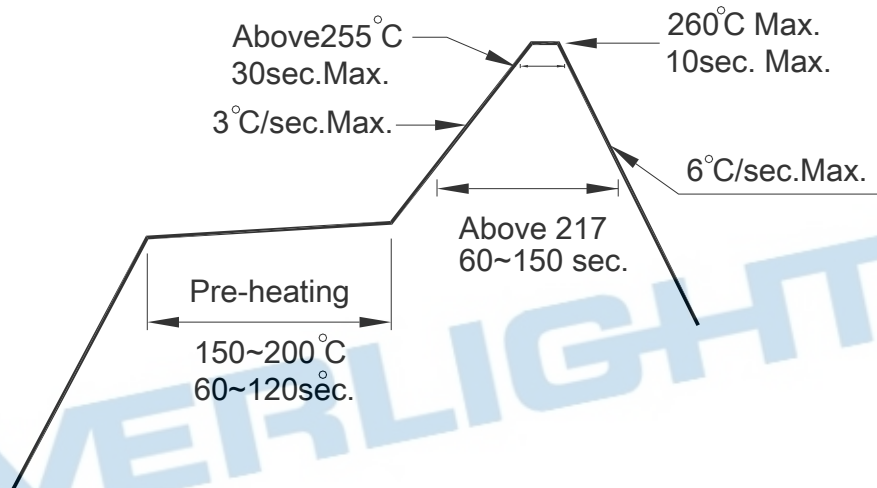

3.2 Reflow soldering should not be done more than two times.

3.3 When soldering, do not put stress on the LEDs during heating.

3.4 After soldering, do not warp the circuit board.

4. Soldering Iron

Each terminal is to go to the tip of soldering iron temperature less than 350°C for 3 seconds within once in less than the soldering iron capacity 25W. Leave two seconds and more intervals, and do soldering of each terminal. Be careful because the damage of the product is often started at the time of the hand solder.

5. Repairing

Repair should not be done after the LEDs have been soldered. When repairing is unavoidable, a double-head soldering iron should be used (as below figure). It should be confirmed beforehand whether the characteristics of the LEDs will or will not be damaged by repairing.

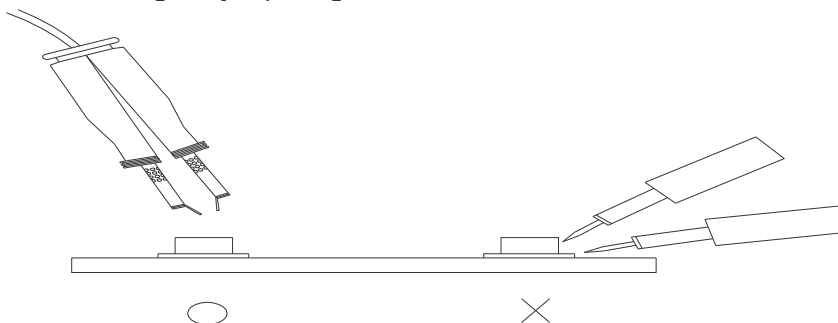

DISCLAIMER

1. EVERLIGHT reserves the right(s) on the adjustment of product material mix for the specification.
2. The product meets EVERLIGHT published specification for a period of twelve (12) months from date of shipment.
3. The graphs shown in this datasheet are representing typical data only and do not show guaranteed values.
4. When using this product, please observe the absolute maximum ratings and the instructions for using outlined in these specification sheets. EVERLIGHT assumes no responsibility for any damage resulting from the use of the product which does not comply with the absolute maximum ratings and the instructions included in these specification sheets.
5. These specification sheets include materials protected under copyright of EVERLIGHT. Reproduction in any form is prohibited without obtaining EVERLIGHT's prior consent.
6. This product is not intended to be used for military, aircraft, automotive, medical,