

LAMP EALP05RDHRA4

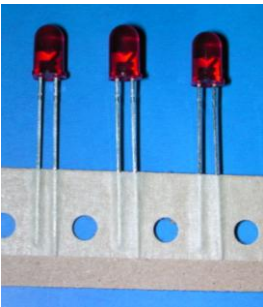

Features

- Long life feature.
- Low power consumption.
- High emitting efficiency.
- Most radial lead plastic LED lamp available packed in tape and reel.
- Reel package simplifies handling and test.
- The product itself will remain within RoHS compliant version
- Compliance with EU REACH
- Compliance Halogen Free .(Br <900 ppm ,Cl <900 ppm , Br+Cl < 1500 ppm)

Description

- The ELA lamps are made with AlGaInP diodes which emit Deep - Red.
- Automatically insertable with radial lead insertion equipment.

Applications

- Audio equipment
- Monitor
- Sign board
- Computer peripheral
- Air condition
- Home appliance
- Satellite receiver
- Burglar alarm
- Stop light

Device Selection Guide

PART NO.	Chip Materials	Emitted Color	Resin Color
EALP05RDHRA4	AlGaInP	Deep - Red	Red Diffused

Absolute Maximum Ratings (Ta=25°C)

Parameter	Symbol	Rating	Unit
Continuous Forward Current	I_F	25	mA
Peak Forward Current (Duty 1/10 @ 1KHZ)	I_{FP}	60	mA
Reverse Voltage	V_R	5	V
Power Dissipation	P_d	60	mW
Operating Temperature	T_{opr}	-40 ~ +85	°C
Storage Temperature	T_{stg}	-40 ~ +100	°C
Soldering Temperature	T_{sol}	260 °C for 5 sec.	

Electro-Optical Characteristics (Ta=25°C)

Parameter	Symbol	Min.	Typ.	Max.	Unit	Condition
Luminous Intensity	I_v	160.0	320.0	-----	mcd	$I_F=20mA$
Viewing Angle	$2\theta_{1/2}$	-----	30	-----	deg	$I_F=20mA$
Peak Wavelength	λ_p	-----	650	-----	nm	$I_F=20mA$
Dominant Wavelength	λ_d	-----	639	-----	nm	$I_F=20mA$
Spectrum Radiation Bandwidth	$\Delta\lambda$	-----	20	-----	nm	$I_F=20mA$
Forward Voltage	V_F	1.7	2.0	2.4	V	$I_F=20mA$
Reverse Current	I_R	-----	-----	10	μA	$V_R=5V$

Typical Electro-Optical Characteristics Curves

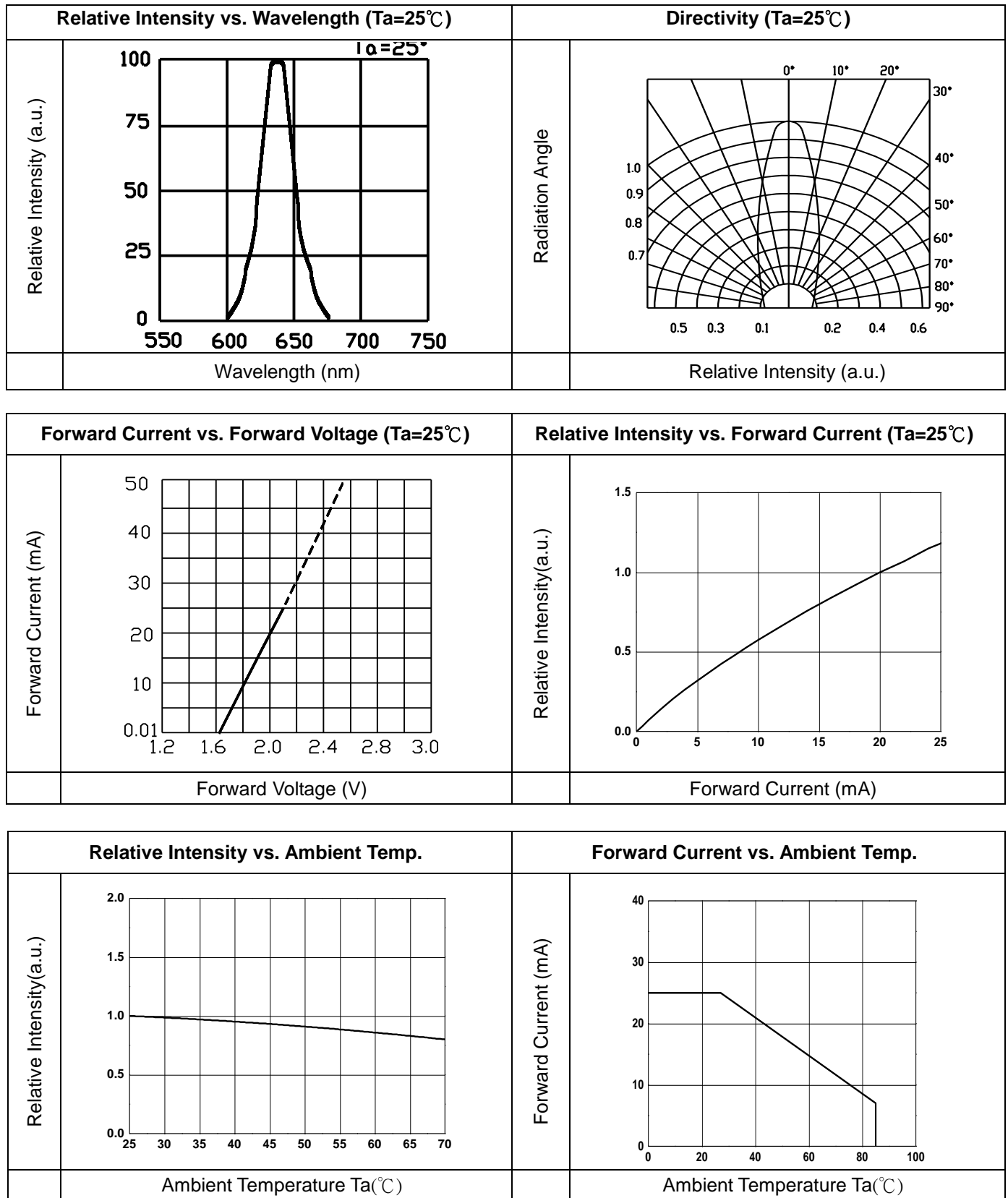

Package Dimension

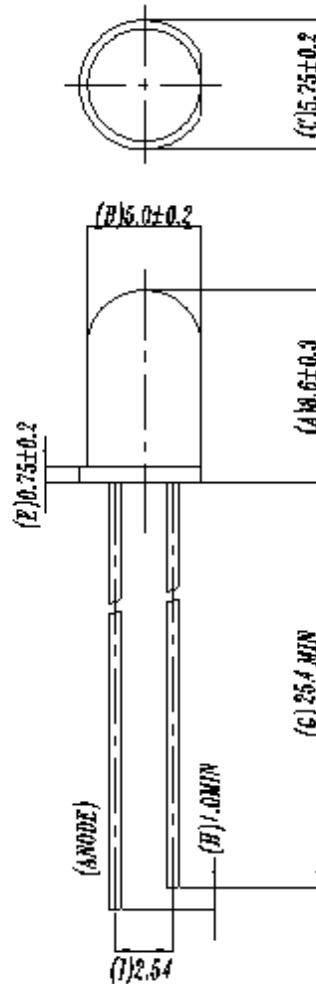

Notes:

1. All dimensions are in millimeters, tolerance is $\pm 0.25\text{mm}$ except being specified
2. Lead spacing is measured where the lead emerge from the package
3. Protruded resin under flange is 1.5 mm(0.059") Max LED.
4. The single LED picture which is after taping.

Carrier Tape Dimensions:

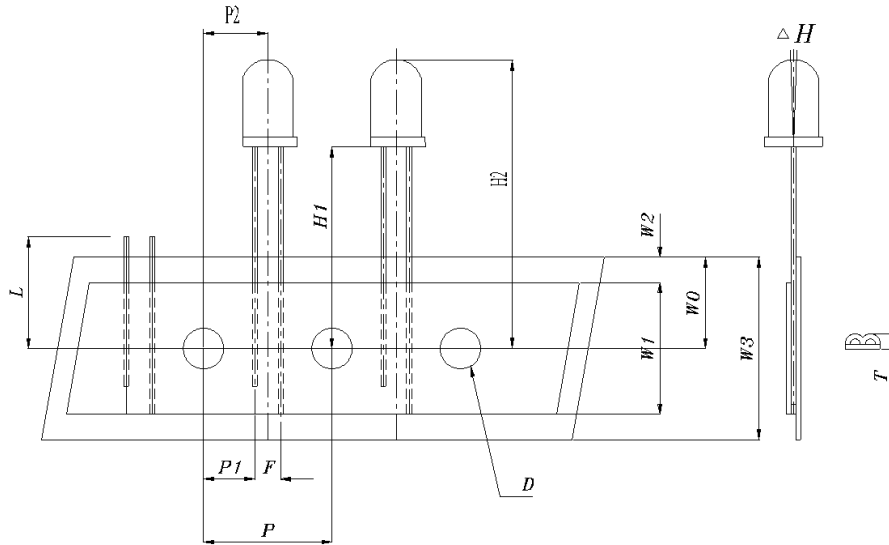

Notes:

- 1.All dimensions are in millimeters, tolerance is $\pm 0.25\text{mm}$ except being specified
- 2.Lead spacing is measured where the lead emerge from the package

Taping Sizes

Symbol Items	Symbol	Specifications		
		Avg.		Tolerance (mm)
		mm	Inch	
Tape Feed Hole Diameter	D	4.0	0.157	± 0.2
Component Lead Pitch	F	2.54	0.100	$+0.8/-0.2$
Front-to-Read Deflection	ΔH	0°	0	$\pm 5^\circ$
Feed Hole to Button of Component	H1	21.50	0.846	± 1.0
Feed Hole to Overall Component Height	H2	30.10	1.185	± 1.0
Lead Length after Component Removal	L	11.00	0.433	MAX
Feed Hole Pitch	P	12.70	0.500	± 0.3
Lead Location	P1	5.08	0.200	± 0.7
Center of Component Location	P2	6.35	0.250	± 1.2
Overall Taped Package Thickness	T	1.42	0.056	MAX
Feed Hole Location	W0	9.00	0.354	± 0.5
Adhesive Tape Width	W1	13.00	0.512	± 0.5
Adhesive Tape Position	W2	2.00	0.079	MAX
Tape Width	W3	18.00	0.709	± 0.75

Note: Tolerances unless mentioned $\pm 0.1\text{mm}$. Unit = mm

Moisture Resistant Packing Materials

Label Explanation

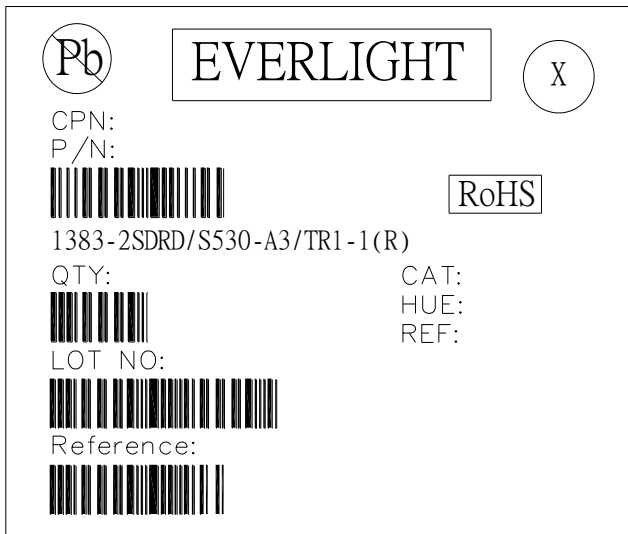

CPN: Customer's Production Number

P/N : Production Number

QTY: Packing Quantity

CAT: Ranks of Luminous Intensity

HUE: Ranks of Color Rank

REF: Ranks of Forward Voltage

LOT No: Lot Number

Packing Specification

■ Tape

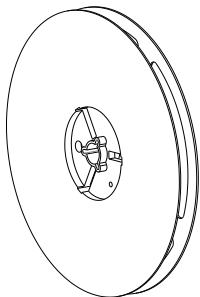

■ Inner Carton

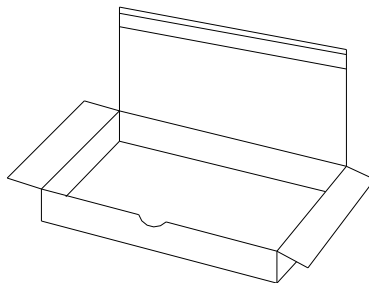

■ Outside Carton

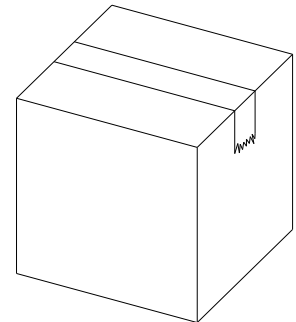

■ Packing Quantity

1. 1000 PCS/Tape, 2 Tapes/Inner Carton
2. 5 Inner Cartons/Outer box

Notes

1. Lead Forming
 - During lead formation, the leads should be bent at a point at least 3mm from the base of the epoxy bulb.
 - Lead forming should be done before soldering.
 - Avoid stressing the LED package during leads forming. The stress to the base may damage the LED's characteristics or it may break the LEDs.
 - Cut the LED lead frames at room temperature. Cutting the lead frames at high temperatures may cause failure of the LEDs.
 - When mounting the LEDs onto a PCB, the PCB holes must be aligned exactly with the lead position of the LED. If the LEDs are mounted with stress at the leads, it causes deterioration of the epoxy resin and this will degrade the LEDs.
2. Storage
 - The LEDs should be stored at 30°C or less and 70%RH or less after being shipped from Everlight Americas and the storage life limits are 3 months. If the LEDs are stored for 3 months or more, they can be stored for a year in a sealed container with a nitrogen atmosphere and moisture absorbent material.
 - Please avoid rapid transitions in ambient temperature, especially, in high humidity environments where condensation can occur.
3. Soldering
 - Careful attention should be paid during soldering. When soldering, leave more than 3mm from solder joint to epoxy bulb, and soldering beyond the base of the tie bar is recommended.

Recommended soldering conditions:

Hand Soldering		DIP Soldering	
Temp. at tip of iron	300°C Max. (30W Max.)	Preheat temp.	100°C Max. (60 sec Max.)
Soldering time	3 sec Max.	Bath temp. & time	260 Max., 5 sec Max
Distance	3mm Min. (From solder joint to epoxy bulb)	Distance	3mm Min. (From solder joint to epoxy bulb)

- Recommended soldering profile

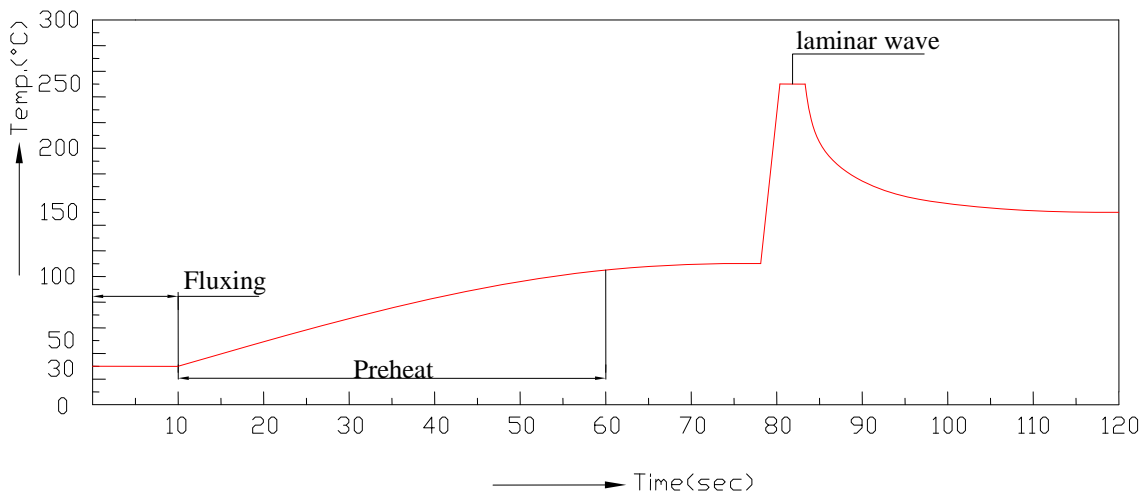

- Avoiding applying any stress to the lead frame while the LEDs are at high temperature particularly when soldering.
- Dip and hand soldering should not be done more than one time
- After soldering the LEDs, the epoxy bulb should be protected from mechanical shock or vibration until the LEDs return to room temperature.
- A rapid-rate process is not recommended for cooling the LEDs down from the peak temperature.

- Although the recommended soldering conditions are specified in the above table, dip or hand soldering at the lowest possible temperature is desirable for the LEDs.
 - Wave soldering parameter must be set and maintain according to recommended temperature and dwell time in the solder wave.
4. Cleaning
- When necessary, cleaning should occur only with isopropyl alcohol at room temperature for a duration of no more than one minute. Dry at room temperature before use.
 - Do not clean the LEDs by the ultrasonic. When it is absolutely necessary, the influence of ultrasonic cleaning on the LEDs depends on factors such as ultrasonic power and the assembled condition. Ultrasonic cleaning shall be pre-qualified to ensure this will not cause damage to the LED
5. Heat Management
- Heat management of LEDs must be taken into consideration during the design stage of LED application. The current should be de-rated appropriately by referring to the de-rating curve found in each product specification.
 - The temperature surrounding the LED in the application should be controlled. Please refer to the data sheet de-rating curve.
6. ESD (Electrostatic Discharge)
- The products are sensitive to static electricity or surge voltage. ESD can damage a die and its reliability. When handling the products, the following measures against electrostatic discharge are strongly recommended:
 - Eliminating the charge
 - Grounded wrist strap, ESD footwear, clothes, and floors
 - Grounded workstation equipment and tools
 - ESD table/shelf mat made of conductive materials
 - Proper grounding is required for all devices, equipment, and machinery used in product assembly. Surge protection should be considered when designing of commercial products.
 - If tools or equipment contain insulating materials such as glass or plastic, the following measures against electrostatic discharge are strongly recommended:
 - Dissipating static charge with conductive materials
 - Preventing charge generation with moisture
 - Neutralizing the charge with ionizers
7. Directions for use
- The LEDs should be operated with forward bias. The driving circuit must be designed so that the LEDs are not subjected to forward or reverse voltage while it is off. If reverse voltage is continuously applied to the LEDs, it may cause migration resulting in LED damage.
8. Other
- Above specification may be changed without notice. EVERLIGHT AMERICAS will reserve authority on material change for above specification.
 - When using this product, please observe the absolute maximum ratings and the instructions for using outlined in these specification sheets. EVERLIGHT AMERICAS assumes no responsibility for any damage resulting from use of the product which does not comply with the absolute maximum ratings and the instructions included in these specification sheets.

- These specification sheets include materials protected under copyright of EVERLIGHT AMERICAS corporation. Please don't reproduce or cause anyone to reproduce them without EVERLIGHT's AMERICAS's consent.