

Technical Data Sheet

High Power Infrared LED

EAILP03SXCA0

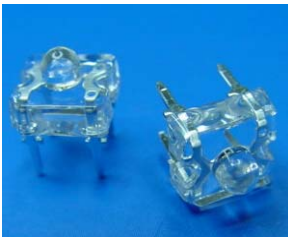

Features

- High reliability
- 2.54mm lead spacing
- Low forward voltage
- Good spectral matching to Si photodetector
- High radiant intensity
- Pb free
- The product itself will remain within RoHS compliant version.

Description

- Everlight Americas Infrared Emitting Diode(EAILP03SXCA0) is a high intensity diode , molded in a water clear plastic package.
- The device is spectrally matched with phototransistor , photodiode and infrared receiver module.

Applications

- CCTV
- Infrared applied system

Device Selection Guide

LED Part No.	Chip Material	Lens Color
EAILP03SXCA0	GaAIAs	Water clear

Absolute Maximum Ratings (Ta=25°C)

Parameter	Symbol	Rating	Unit
Continuous Forward Current	I_F	100	mA
Peak Forward Current	I_{FP}	1.0	A
Reverse Voltage	V_R	5	V
Operating Temperature	T_{opr}	-40~ +85	°C
Storage Temperature	T_{stg}	-40 ~ +100	°C
Soldering Temperature	T_{sol}	260	°C
Power Dissipation at(or below) 25°C Free Air Temperature	P_d	200	mW

Notes: *1: I_{FP} Conditions--Pulse Width $\leq 100\mu s$ and Duty $\leq 1\%$.

*2:Soldering time ≤ 5 seconds.

Electro-Optical Characteristics (Ta=25°C)

Parameter	Symbol	Min.	Typ.	Max.	Unit	Condition
Radiant Intensity	I_E	7.8	17	--	mWsr	$I_F=20mA$
		--	85	--		$I_F=100mA$
Peak Wavelength	λ_p	--	850	--	nm	$I_F=20mA$
Spectral Bandwidth	$\Delta\lambda$	--	50	--	nm	$I_F=20mA$
Forward Voltage	V_F	--	1.45	1.65	V	$I_F=20mA$
		--	1.80	2.40		$I_F=100mA$
Reverse Current	I_R	--	--	10	μA	$V_R=5V$
View Angle	$2\theta_{1/2}$	--	30	--	deg	$I_F=20mA$

Rank

Condition: $I_F=20mA$

Unit : mW/sr

Bin number	M	N	P	Q
Min	7.8	11.0	15.0	21.0
Max	12.5	17.6	24.0	34.0

Fig.1 Forward Current vs. Ambient Temperature

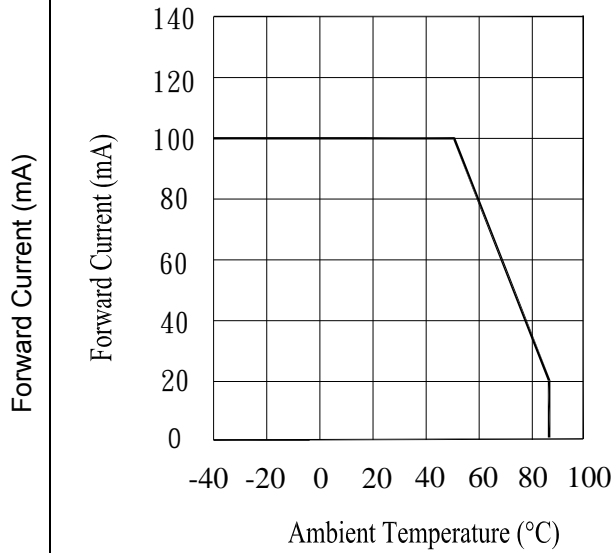
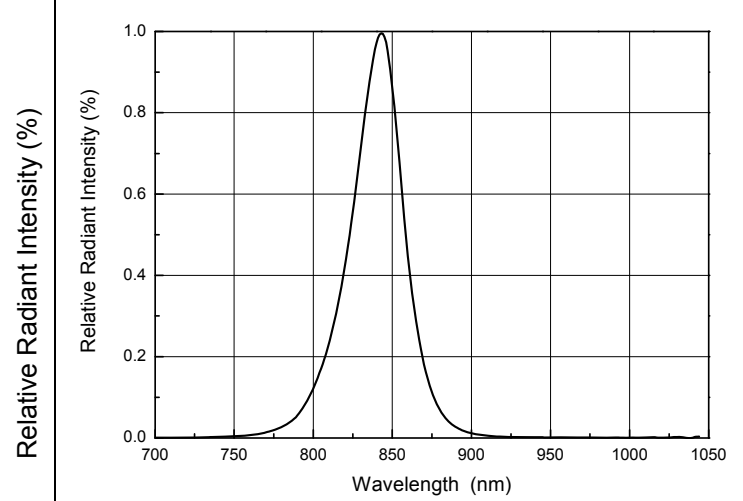

Fig.2 Spectral Distribution



Ambient Temperature(°C)

Wavelength λ (nm)

Fig.3 Radiant Intensity vs. Forward Current

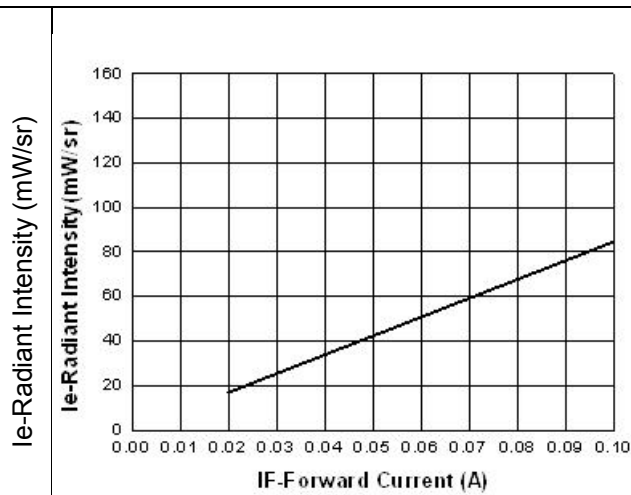
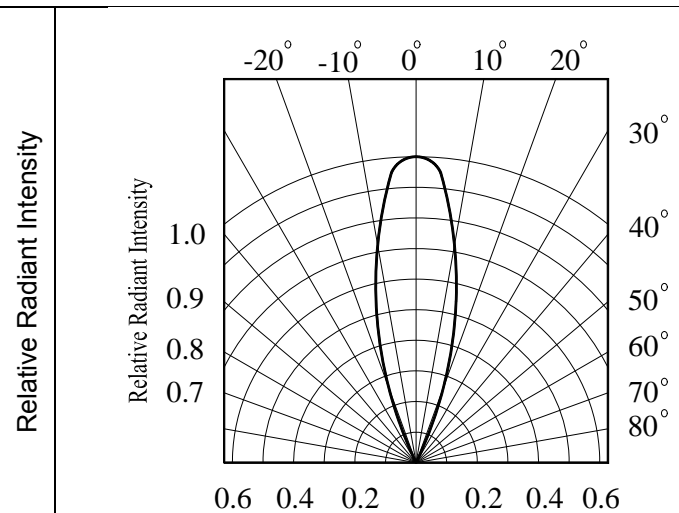
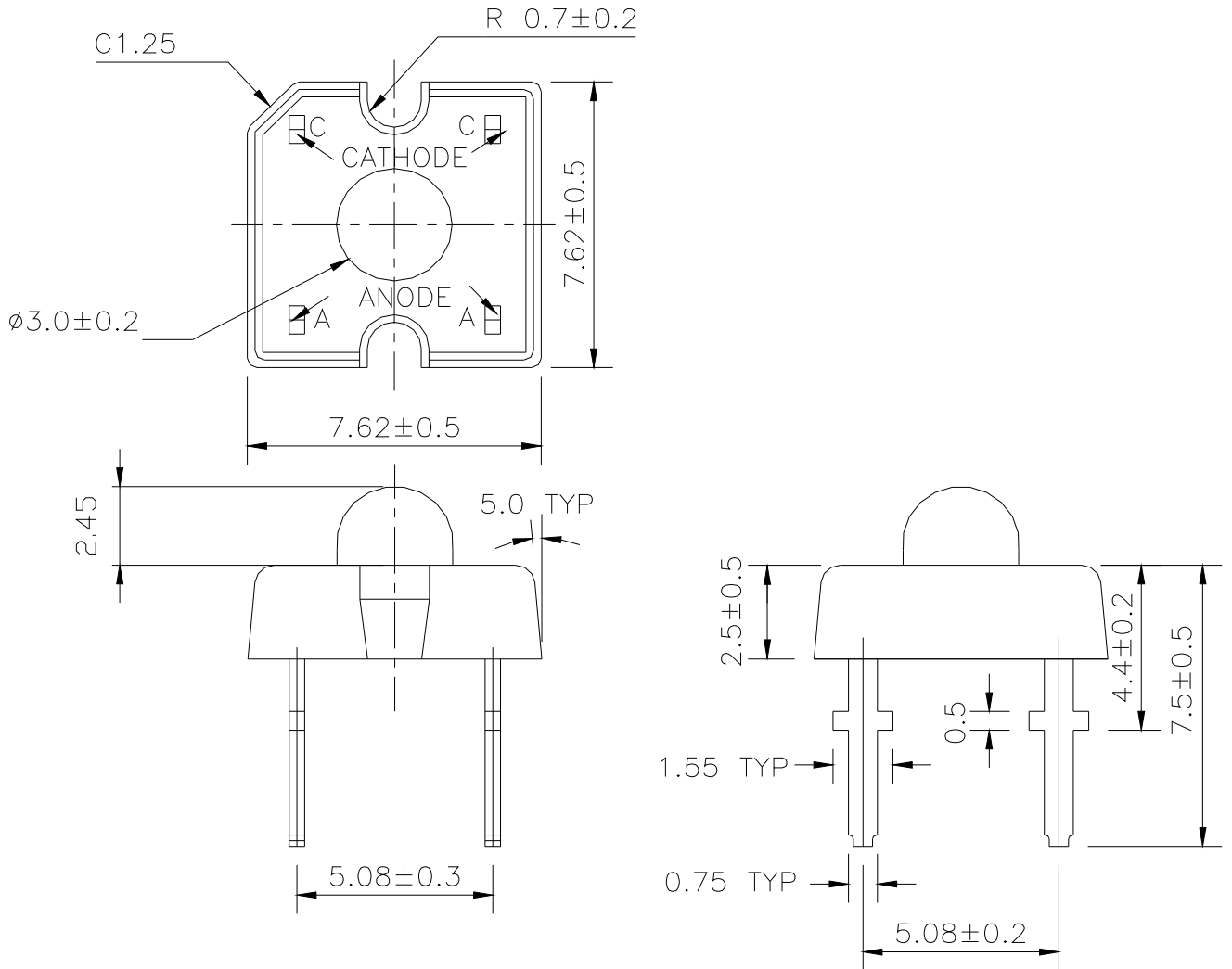

Fig.4 Relative Radiant Intensity vs. Angular Displacement



Package Dimension



- Notes: 1. All dimensions are in millimeters
2. Tolerances unless dimensions ± 0.25 mm

Moisture Resistant Packing Materials

Label Form Specification

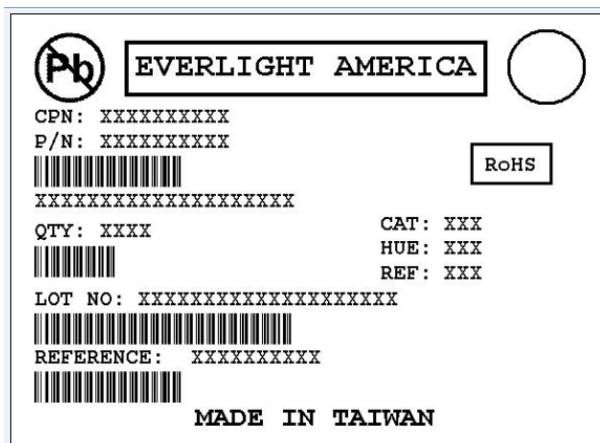

CPN: Customer's Production Number

P/N : Production Number

QTY: Packing Quantity

CAT: Ranks

HUE: Peak Wavelength

REF: Reference

LOT No: Lot Number

MADE IN TAIWAN: Production Place

Notes

1. Above specification may be changed without notice. Everlight Americas will reserve authority on material change for above specification.
2. When using this product, please observe the absolute maximum ratings and the instructions for using outlined in these specification sheets. Everlight Americas assumes no responsibility for any damage resulting from use of the product which does not comply with the absolute maximum ratings and the instructions included in these specification sheets.
3. These specification sheets include materials protected under copyright of Everlight Americas corporation. Please don't reproduce or cause anyone to reproduce them without Everlight Americas's consent