

### SMD ■ REFLECTOR EAPL3527WA6

PRELIMINARY



#### Features

- Fluorescence Type
- High Luminous Intensity
- High Efficiency
- Emission Color:x=0.29,y=0.30
- Pb free
- The product itself will remain within RoHS compliant version.
- ESD protection.

#### Applications

- OA Equipment
- Backlighting of Full Color LCD
- Automotive Equipment
- Replacement of Conventional Light
- Bulbs and Fluorescent Lamps

## Device Selection Guide

Chip Materials	Emitted Color	Resin Color
InGaN	White	Water Clear

## Absolute Maximum Ratings (Ta=25°C)

Parameter	Symbol	Rating	Unit
Reverse Voltage	VR	5	V
Forward Current	IF	25	mA
Operating Temperature	Topr	-40 ~ +85	°C
Storage Temperature	Tstg	-40 ~ +90	°C
Electrostatic Discharge(HBM)	ESD	2000	V
Power Dissipation	Pd	110	mW
Peak Forward Current (Duty 1/10 @1KHz)	IFP	100	mA
Soldering Temperature	Tsol	Reflow Soldering : 260 °C for 10 sec. Hand Soldering : 350 °C for 3 sec.	

### Electro-Optical Characteristics (Ta=25°C)

Parameter	Symbol	Min.	Typ.	Max.	Units	Condition
Luminous Intensity	I <sub>v</sub>	715	-----	1800	mcd	I <sub>F</sub> =20mA
Forward Voltage	V <sub>F</sub>	2.70	-----	3.50	V	I <sub>F</sub> =20mA
Viewing Angle	2θ1/2	--	120	--	deg	I <sub>F</sub> =20mA

Note:

1. Tolerance of Luminous Intensity: ±11%
2. Tolerance of Dominant Wavelength: ±1nm
3. Tolerance of Forward Voltage: ±0.1V

### Bin Range of Luminous Intensity

Bin Code	Min.	Max.	Unit	Condition
V1	715	900	mcd	I <sub>F</sub> =20mA
V2	900	1120		
W1	1120	1420		
W2	1420	1800		

Note:

Tolerance of Luminous Intensity: ±11%

### Bin Range of Forward Voltage

Group	Bin Code	Min.	Max.	Unit	Condition
N	10	2.70	2.90	V	I <sub>f</sub> =20mA
	11	2.90	3.10		
	12	3.10	3.30		
	13	3.30	3.50		
	14	3.50	3.70		

Note: Tolerance of Forward Voltage: ±0.1V

### Bin Range of Chromaticity Coordinates

Group	Bin Code	CIE_x	CIE_y	Bin Code	CIE_x	CIE_y
F	B3	0.287	0.295	B4	0.307	0.315
		0.283	0.305		0.304	0.33
		0.304	0.330		0.33	0.36
		0.307	0.315		0.33	0.339
	B5	0.296	0.276	B6	0.311	0.294
		0.287	0.295		0.307	0.315
		0.307	0.315		0.330	0.339
		0.311	0.294		0.330	0.318

Note:

Tolerance of Chromaticity Coordinates: ±0.01

The C.I.E. 1931 chromaticity diagram.

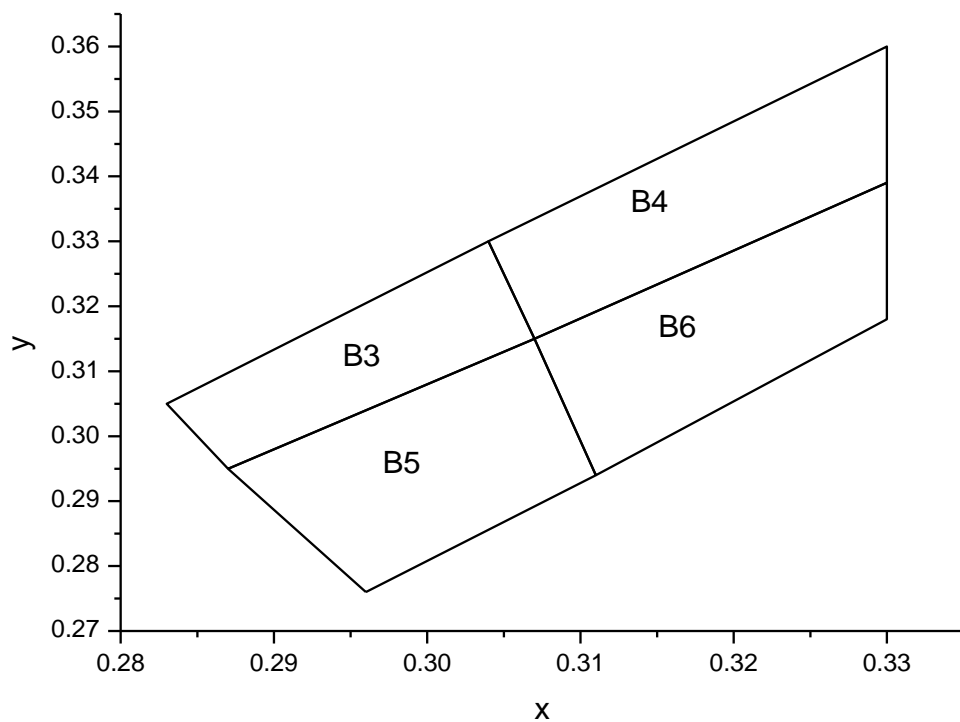

### Typical Electro-Optical Characteristics Curves

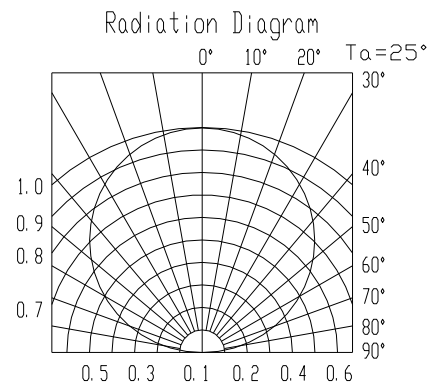
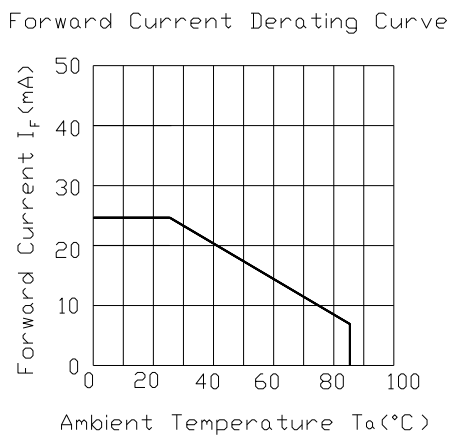
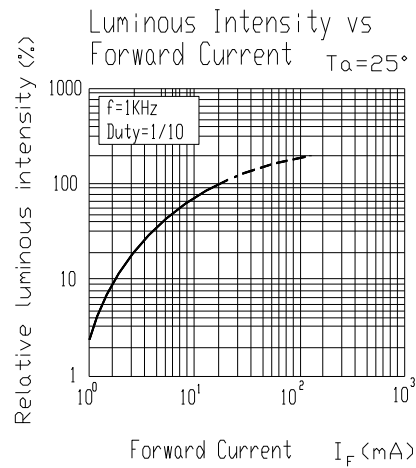
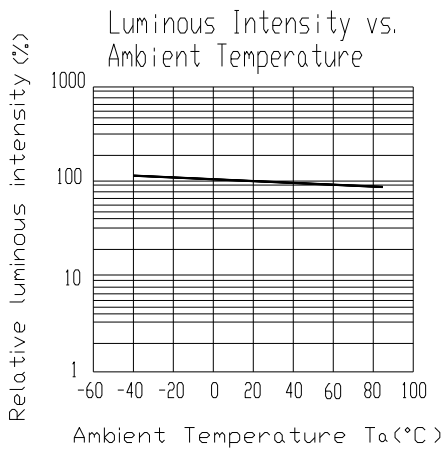
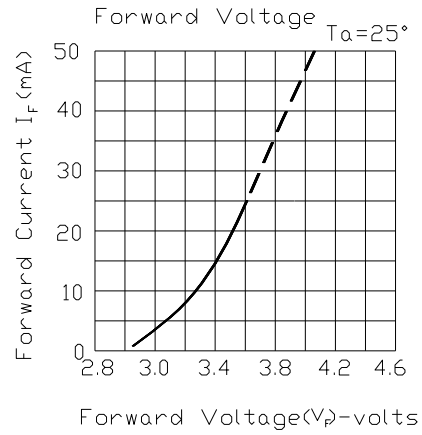
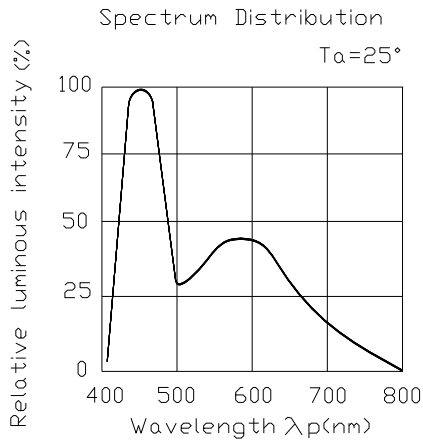

**Package Dimension**

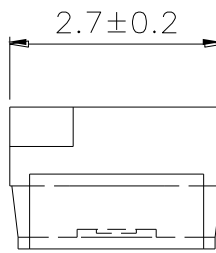
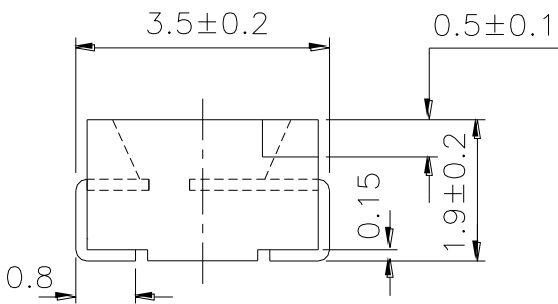
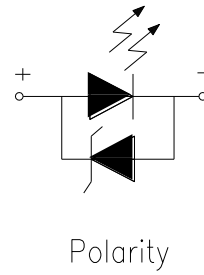
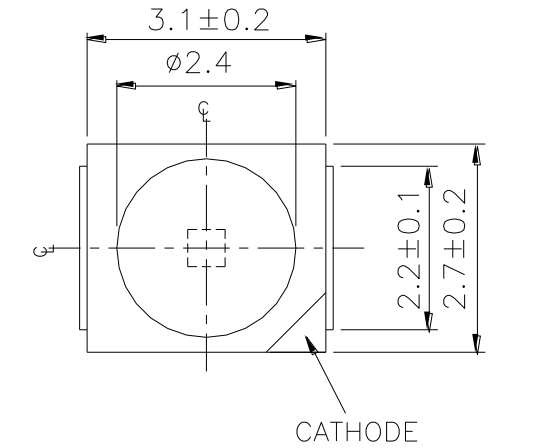

For reflow soldering (Proposal)

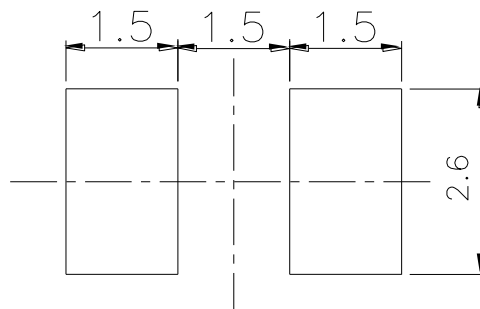
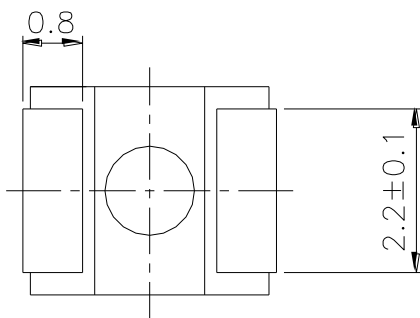

Note: Tolerances unless mentioned ±0.1mm. Unit = mm

## Moisture Resistant Packing Materials

### Label Explanation

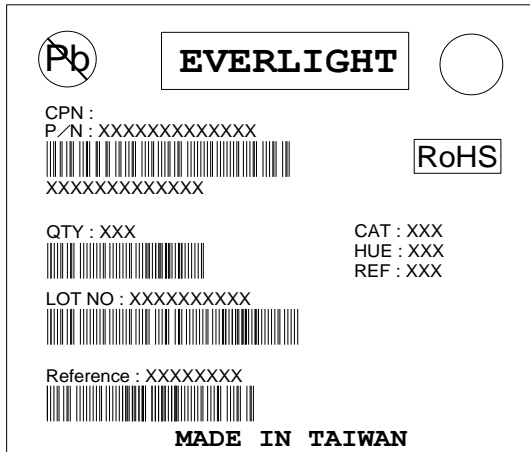

CAT: Luminous Intensity Rank

HUE: Dom. Wavelength Rank

REF: Forward Voltage Rank

### Reel Dimensions

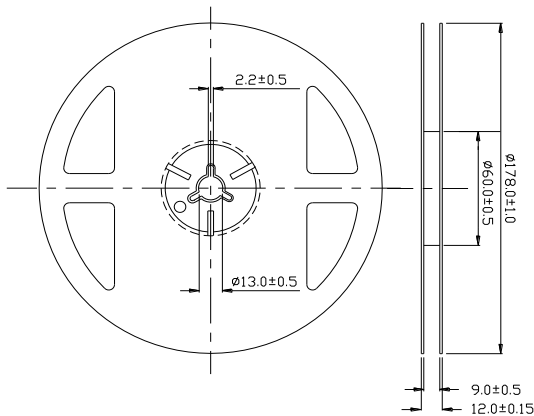

### Carrier Tape Dimensions: Loaded Quantity 2000 pcs Per Reel

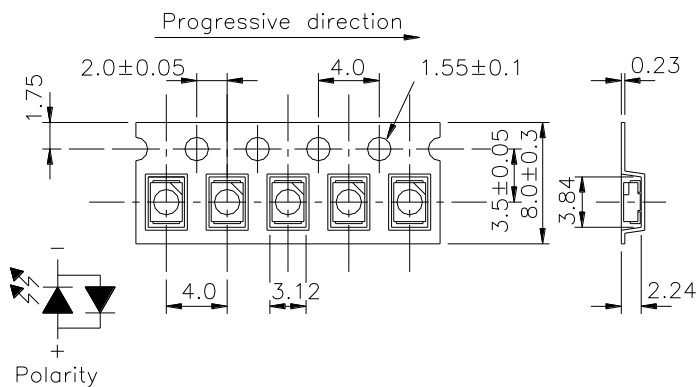

Note: Tolerances unless mentioned  $\pm 0.1$ mm. Unit = mm



### Moisture Resistant Packing Process

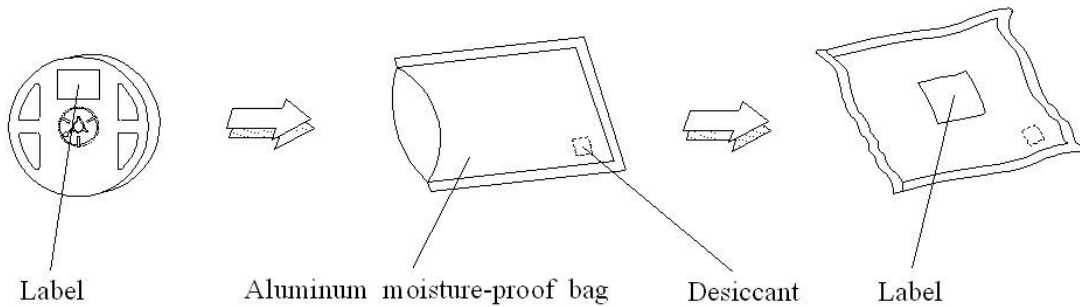

Note: Tolerances unless mentioned  $\pm 0.1\text{mm}$ . Unit = mm

### Reliability Test Items and Conditions

The reliability of products shall be satisfied with items listed below.

Confidence level : 90%

LTPD : 10%

No.	Items	Test Condition	Test Hours/Cycles	Sample Size	Ac/Re
1	Reflow Soldering	Temp. : $260^{\circ}\text{C} \pm 5^{\circ}\text{C}$ Min. 5sec.	6 min	22 PCS.	0/1
2	Temperature Cycle	H : $+100^{\circ}\text{C}$ 15min $\int$ 5 min L : $-40^{\circ}\text{C}$ 15min	300 Cycles	22 PCS.	0/1
3	Thermal Shock	H : $+100^{\circ}\text{C}$ 5min $\int$ 10 sec L : $-10^{\circ}\text{C}$ 5min	300 Cycles	22 PCS.	0/1
4	High Temperature Storage	Temp. : $100^{\circ}\text{C}$	1000 Hrs.	22 PCS.	0/1
5	Low Temperature Storage	Temp. : $-40^{\circ}\text{C}$	1000 Hrs.	22 PCS.	0/1
6	DC Operating Life	IF = 20 mA	1000 Hrs.	22 PCS.	0/1
7	High Temperature / High Humidity	$85^{\circ}\text{C} / 85\% \text{RH}$	1000 Hrs.	22 PCS.	0/1

## Precautions For Use

### 1. Over-current-proof

Customer must apply resistors for protection, otherwise slight voltage shift will cause big current change ( Burn out will happen ).

### 2. Storage

2.1 Do not open moisture proof bag before the products are ready to use.

2.2 Before opening the package: The LEDs should be kept at 30°C or less and 90%RH or less.

2.3 After opening the package: The LED's floor life is 48 hours under 30°C or less and 60% RH or less. If unused LEDs remain, should be stored in moisture proof packages.

2.4 If the moisture absorbent material (silica gel) has faded away or the LEDs have exceeded the storage time, baking treatment should be performed using the following conditions.

Baking treatment : 60±5°C for 24 hours.

### 3. Soldering Condition

#### 3.1 Pb-free solder temperature profile

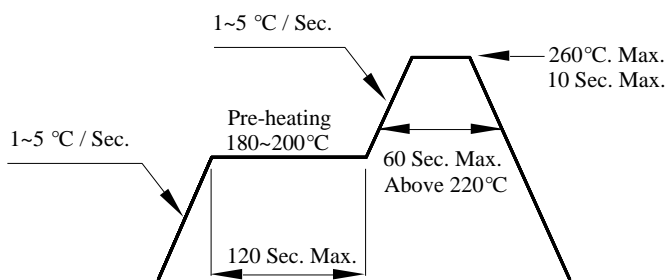

3.2 Reflow soldering should not be done more than two times.

3.3 When soldering, do not put stress on the LEDs during heating.

3.4 After soldering, do not warp the circuit board.

### 4. Soldering Iron

Each terminal is to go to the tip of soldering iron temperature less than 350°C for 3 seconds within once in less than the soldering iron capacity 25W. Leave two seconds and more intervals, and do soldering of each terminal. Be careful because the damage of the product is often started at the time of the hand solder.

### 5. Repairing

Repair should not be done after the LEDs have been soldered. When repairing is unavoidable, a double-head soldering iron should be used (as below figure). It should be confirmed beforehand whether the characteristics of the LEDs will or will not be damaged by repairing.

