

Technical Data Sheet

Side View LED (0.6mm)

99-216/R6C-AQ2S1B/2C

Features

- Side view LED.
- Lead frame package with individual 2 pins.
- Wide viewing angle.
- Soldering methods: IR reflow soldering.
- Pb-free.
- The product itself will remain within RoHS compliant version.



Descriptions

- The 99-216 series is available in soft orange, green, blue and yellow. Due to the package design, the LED has wide viewing angle and optimized light coupling by inter reflector. This feature makes the LED ideal for light guide application.

Applications

- LCD Back Light.
- Mobile phones .
- Indicators.
- Illuminations.
- Switch Lights.

Device Selection Guide

Chip		Resin Color
Material	Emitted Color	
AlGaInP	Brilliant Red	Water Clear

Technical Data Sheet

Side View LED (0.6mm)

99-216/R6C-AQ2S1B/2C

Package Outline Dimensions

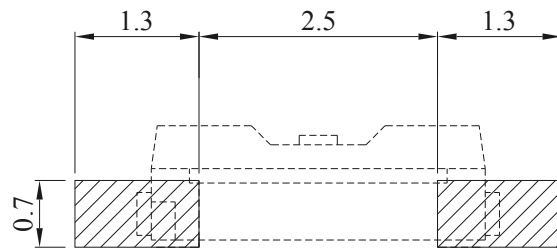
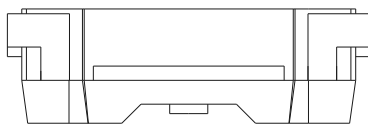
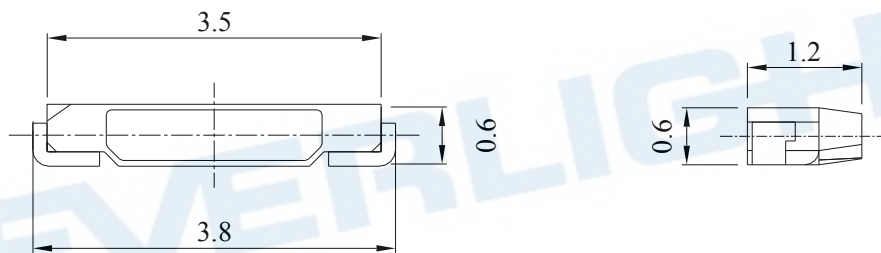
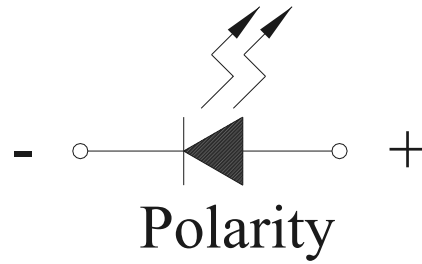
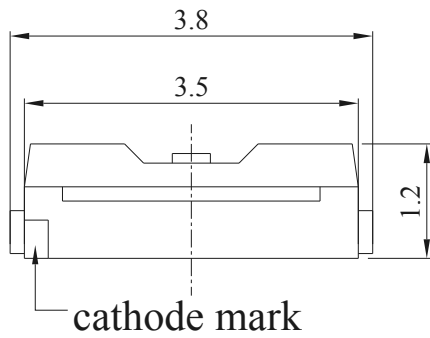

Recommended soldering pad design

Note: The tolerance unless mentioned is $\pm 0.1\text{mm}$, Unit = mm.

Technical Data Sheet**Side View LED (0.6mm)****99-216/R6C-AQ2S1B/2C****Absolute Maximum Ratings (Ta=25°C)**

Parameter	Symbol	Rating	Unit
Reverse Voltage	V_R	5	V
Forward Current	I_F	25	mA
Peak Forward Current (Duty 1/10 @10ms)	I_{FP}	60	mA
Power Dissipation	P_d	60	mW
Electrostatic Discharge(HBM)* ¹	ESD	2000	V
Operating Temperature	T_{opr}	-40 ~ +85	°C
Storage Temperature	T_{stg}	-40 ~ +90	°C
Soldering Temperature	T_{sol}	Reflow Soldering : 260 °C for 10 sec. Hand Soldering : 350 °C for 3 sec.	

Electro-Optical Characteristics (Ta=25°C)

Parameter	Symbol	Min.	Typ.	Max.	Unit	Condition
Luminous Intensity	I_V	90	---	225	mcd	$I_F=20mA$
Viewing Angle	2θ _{1/2}	-----	110	-----	deg	$I_F=20mA$
Peak Wavelength	λ_p	617.5	-----	633.5	nm	$I_F=20mA$
Dominant Wavelength	λ_d	-----	624	-----	nm	$I_F=20mA$
Spectrum Radiation Bandwidth	$\Delta \lambda$	-----	20	-----	nm	$I_F=20mA$
Forward Voltage	V_F	1.75	-----	2.35	V	$I_F=20mA$
Reverse Current	I_R	-----	-----	10	μA	$V_R=5V$

Notes:

- 1.Tolerance of Luminous Intensity : ±11%
- 2.Tolerance of Dominant Wavelength : ±1nm
- 3.Tolerance of Forward Voltage : ±0.1V

Technical Data Sheet**Side View LED (0.6mm)****99-216/R6C-AQ2S1B/2C****Bin Range of Luminous Intensity**

Bin	Min	Max	Unit	Condition
Q2	90	112	mcd	I _F =20mA
R1	112	140		
R2	140	180		
S1	180	225		

Bin Range of Dominant Wavelength

Group	Bin Code	Min.	Max.	Unit	Condition
A	E4	617.5	621.5	nm	I _F =20mA
	E5	621.5	625.5		
	E6	625.5	629.5		
	E7	629.5	633.5		

Bin Range of Forward Voltage

Group	Bin Code	Min.	Max.	Unit	Condition
B	0	1.75	1.95	V	I _F =20mA
	1	1.95	2.15		
	2	2.15	2.35		

Notes:

- 1.Tolerance of Luminous Intensity : ±11%
- 2.Tolerance of Dominant Wavelength : ±1nm
- 3.Tolerance of Forward Voltage : ±0.1V

Technical Data Sheet

Side View LED (0.6mm)

99-216/R6C-AQ2S1B/2C

Typical Electro-Optical Characteristics Curves

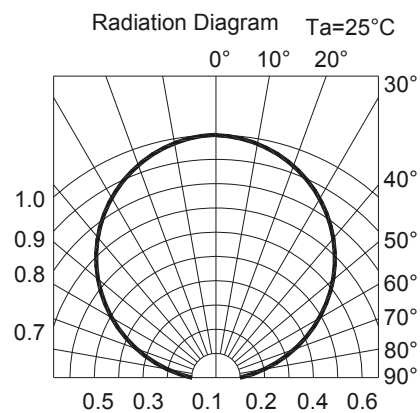
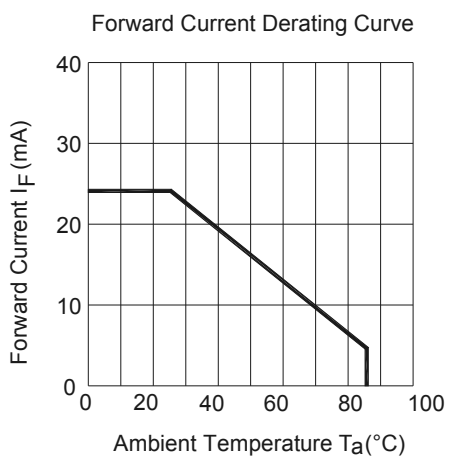
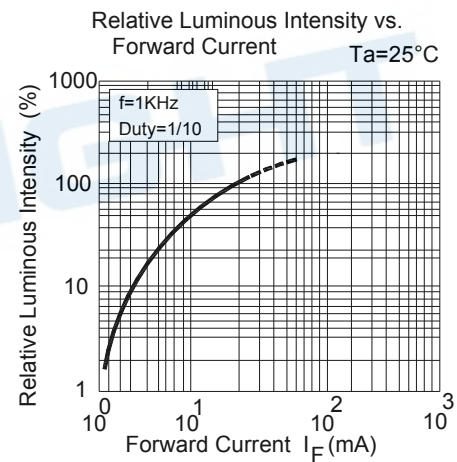
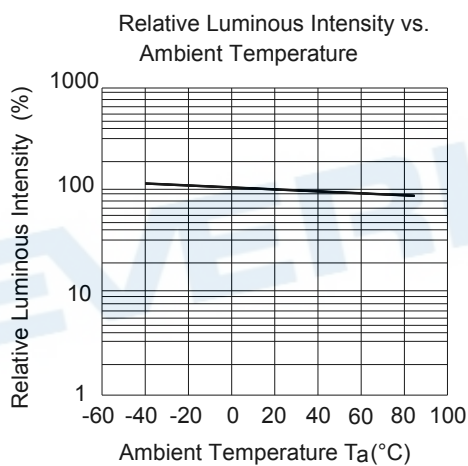
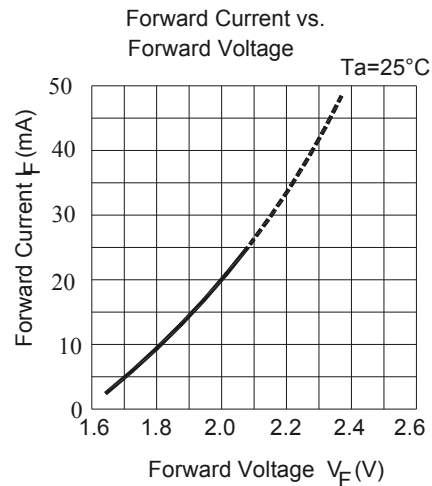
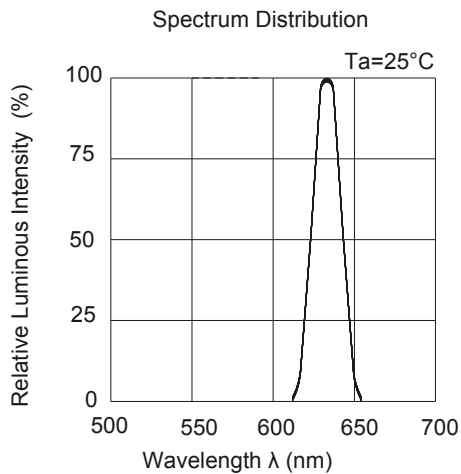

Technical Data Sheet

Side View LED (0.6mm)

99-216/R6C-AQ2S1B/2C

Label Explanation

CAT: Luminous Intensity Rank

HUE: Dom. Wavelength Rank

REF: Forward Voltage Rank

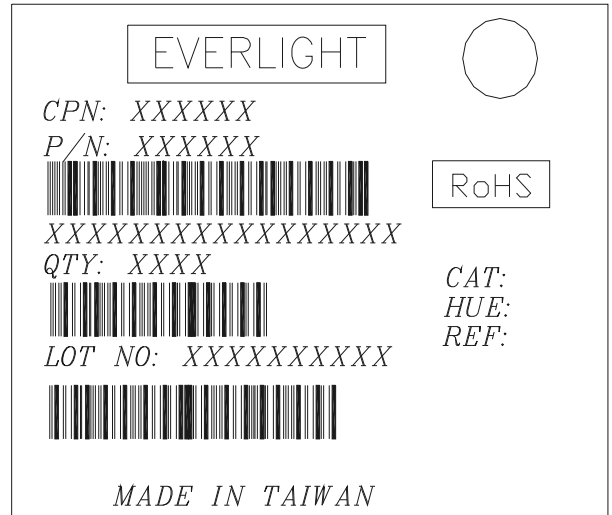

Reel Dimensions

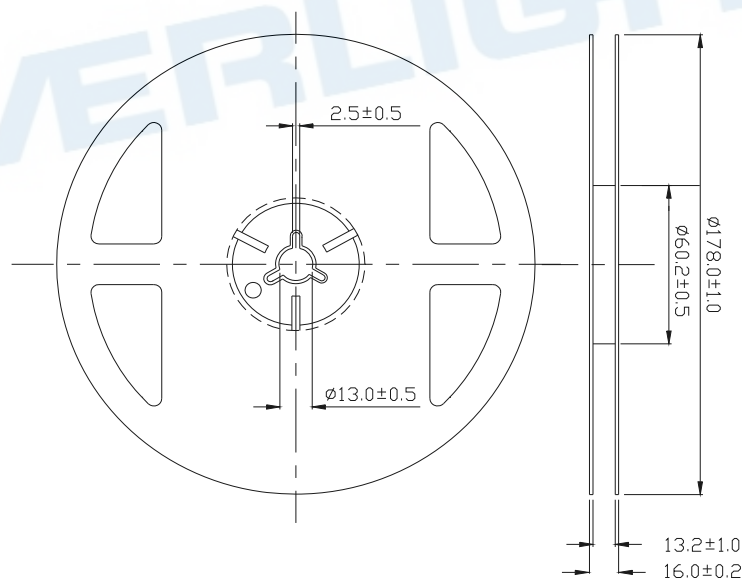

Note: The tolerance unless mentioned is ±0.1mm , Unit = mm

Technical Data Sheet

Side View LED (0.6mm)

99-216/R6C-AQ2S1B/2C

Carrier Tape Dimensions: Loaded Quantity 2000 pcs Per Reel

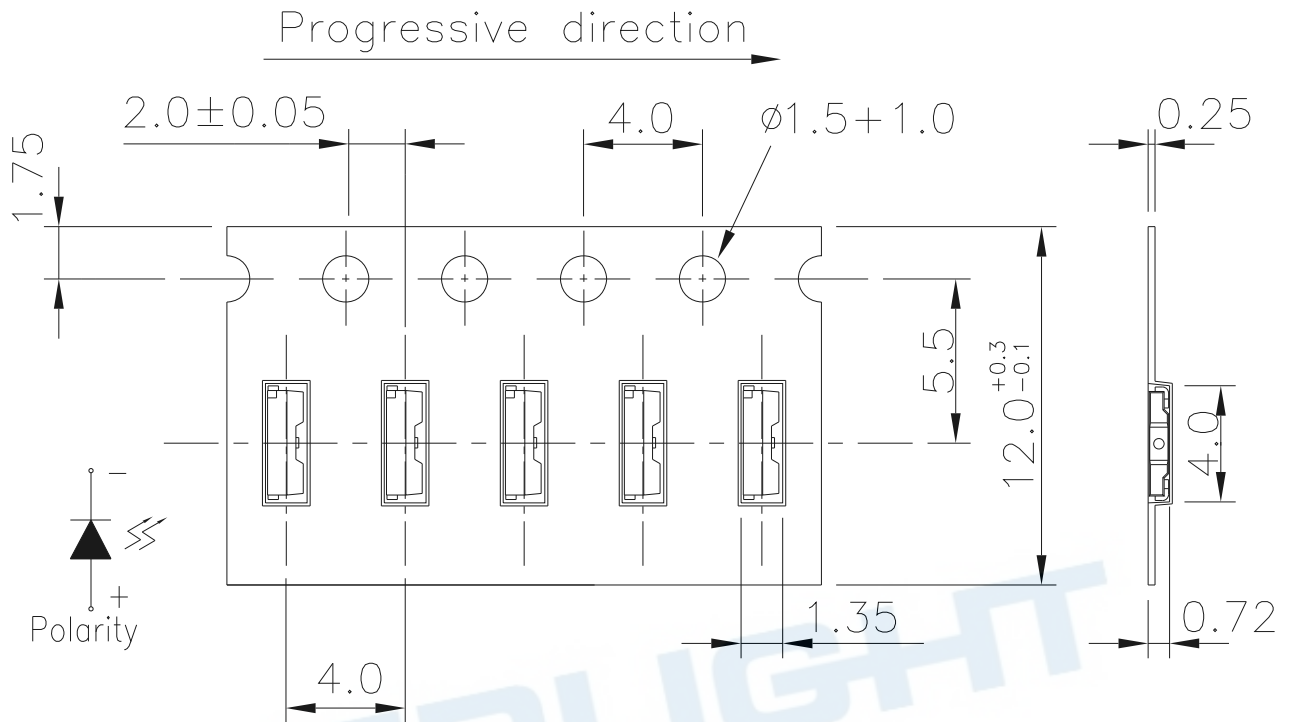

Note: The tolerance unless mentioned is $\pm 0.1\text{mm}$, Unit = mm

Moisture Resistant Packaging

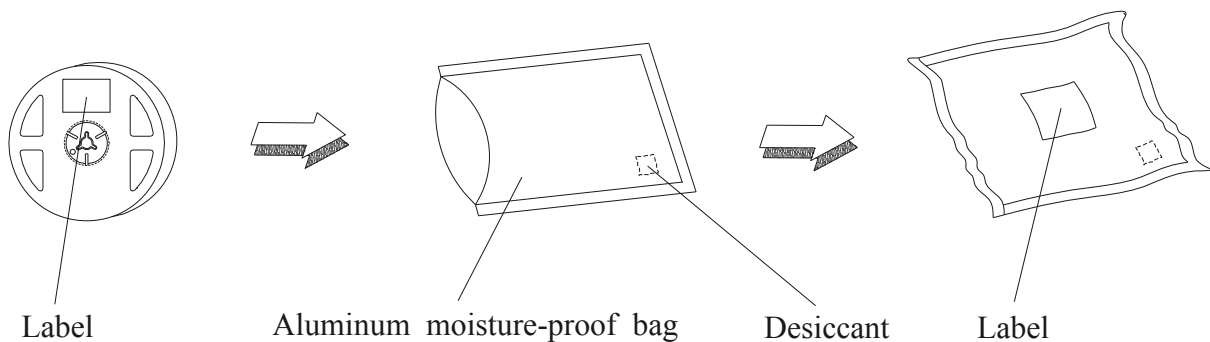

Technical Data Sheet**Side View LED (0.6mm)****99-216/R6C-AQ2S1B/2C****Reliability Test Items And Conditions**

The reliability of products shall be satisfied with items listed below.

Confidence level : 90%

LTPD : 10%

No.	Items	Test Condition	Test Hours/Cycles	Sample Size	Ac/Re
1	Reflow Soldering	Temp. : 260°C±5°C Max. 10 sec.	6 Min.	22 PCS	0/1
2	Temperature Cycle	H : +100°C 15min ∫ 5 min L : -40°C 15min	300 Cycles	22 PCS.	0/1
3	Thermal Shock	H : +100°C 5min ∫ 10 sec L : -10°C 5min	300 Cycles	22 PCS.	0/1
4	High Temperature Storage	Temp. : 100°C	1000 Hrs.	22 PCS.	0/1
5	Low Temperature Storage	Temp. : -40°C	1000 Hrs.	22 PCS.	0/1
6	DC Operating Life	I _F = 20 mA / 25°C	1000 Hrs.	22 PCS.	0/1
7	High Temperature / High Humidity	85°C/85%RH	1000 Hrs.	22 PCS.	0/1

Technical Data Sheet

Side View LED (0.6mm)

99-216/R6C-AQ2S1B/2C

Precautions For Use

1. Over-current-proof

Customer must apply resistors for protection, otherwise slight voltage shift will cause big current change (Burn out will happen).

2. Storage

- 2.1 Do not open moisture proof bag before the products are ready to use.
- 2.2 Before opening the package: The LEDs should be kept at 30°C or less and 90%RH or less.
- 2.3 After opening the package: The LED's floor life is 1 year under 30°C or less and 60% RH or less. If unused LEDs remain, it should be stored in moisture proof packages.
- 2.4 If the moisture absorbent material (silica gel) has faded away or the LEDs have exceeded the storage time, baking treatment should be performed using the following conditions.
Baking treatment : 60±5°C for 24 hours.

3. Soldering Condition

3.1 Pb-free solder temperature profile

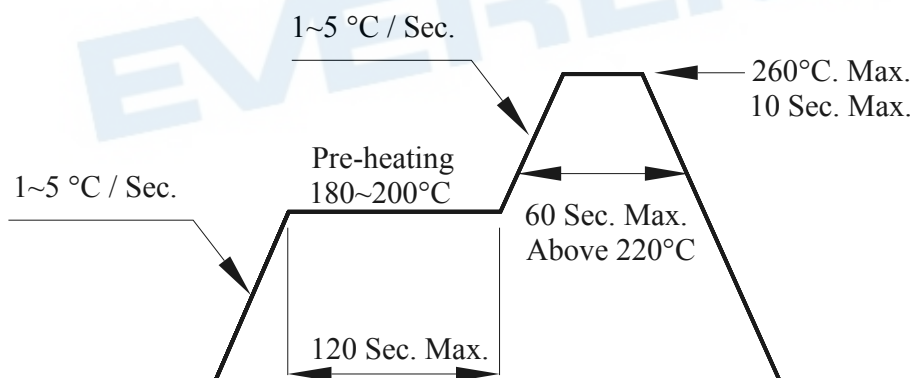

- 3.2 Reflow soldering should not be done more than two times.
- 3.3 When soldering, do not put stress on the LEDs during heating.
- 3.4 After soldering, do not warp the circuit board.

Technical Data Sheet

Side View LED (0.6mm)

99-216/R6C-AQ2S1B/2C

4. Soldering Iron

Each terminal is to go to the tip of soldering iron temperature less than 350°C for 3 seconds within once in less than the soldering iron capacity 25W. Leave two seconds and more intervals, and do soldering of each terminal. Be careful because the damage of the product is often started at the time of the hand solder.

5. Repairing

Repair should not be done after the LEDs have been soldered. When repairing is unavoidable, a double-head soldering iron should be used (as below figure). It should be confirmed beforehand whether the characteristics of the LEDs will or will not be damaged by repairing.

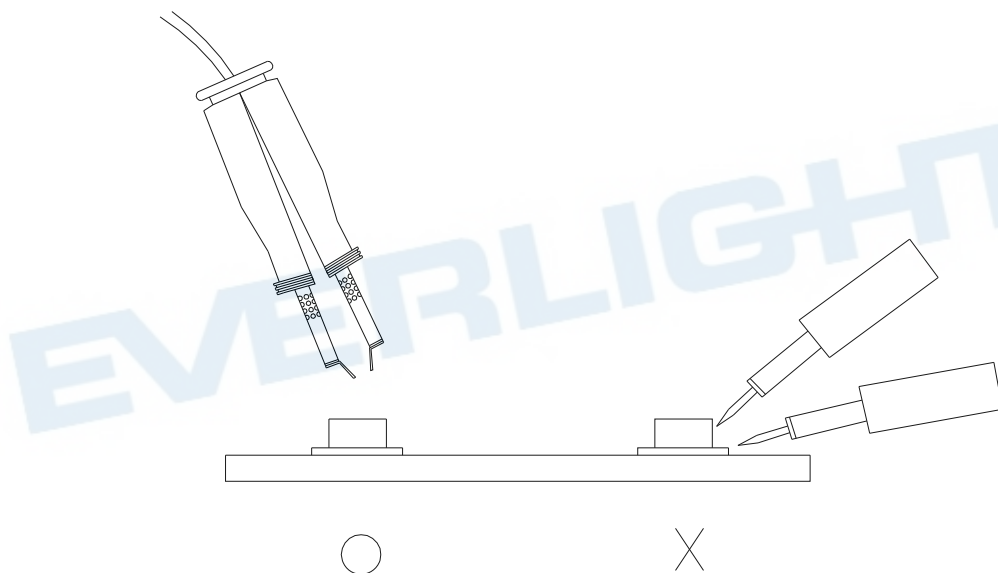

6. Handling Indications

During processing, mechanical stress on the surface should be minimized as much as possible. Sharp objects of all types should not be used to pierce the sealing compound

Technical Data Sheet

Side View LED (0.6mm)

99-216/R6C-AQ2S1B/2C

DISCLAIMER

1. EVERLIGHT reserves the right(s) on the adjustment of product material mix for the specification.
2. The product meets EVERLIGHT published specification for a period of twelve (12) months from date of shipment.
3. The graphs shown in this datasheet are representing typical data only and do not show guaranteed values.
4. When using this product, please observe the absolute maximum ratings and the instructions for using outlined in these specification sheets. EVERLIGHT assumes no responsibility for any damage resulting from the use of the product which does not comply with the absolute maximum ratings and the instructions included in these specification sheets.
5. These specification sheets include materials protected under copyright of EVERLIGHT. Reproduction in any form is prohibited without obtaining EVERLIGHT's prior consent.
6. This product is not intended to be used for military, aircraft, automotive, medical, life sustaining or life saving applications or any other application which can result in human injury or death. Please contact authorized Everlight sales agent for special application request.

EVERLIGHT ELECTRONICS CO., LTD.

Office: No 25, Lane 76, Sec 3, Chung Yang Rd,
Tucheng, Taipei 236, Taiwan, R.O.C

Tel: 886-2-2267-2000, 2267-9936

Fax: 886-2267-6244, 2267-6189, 2267-6306

<http://www.everlight.com>