

SMD ■ TOP View LEDs EAPL3527GA2



Features

- P-LCC-2 package.
- White package.
- Optical indicator.
- Colorless clear window.
- Wide viewing angle.
- Suitable for vapor-phase reflow, Infrared reflow and wave solder processes.
- Computable with automatic placement equipment.
- Available on tape and reel (8mm Tape).
- Pb-free
- The product itself will remain within RoHS compliant version.

Description

The 67-21 series is available in soft orange, green, blue and yellow. Due to the package design, the LED has wide viewing angle and optimized light coupling by inter reflector. This feature makes ideal for light pipe application. The low current requirement makes this device ideal for portable equipment or any other application where power is at a premium.

Applications

- Automotive: backlighting in dashboard and switch.
- Telecommunication: indicator and backlighting in telephone and fax.
- Flat backlight for LCD, switch and symbol.
- Light pipe application.
- General use.

Device Selection Guide

Chip Materials	Emitted Color	Resin Color
InGaN	Brilliant Green	Water Clear

Absolute Maximum Ratings (Ta=25°C)

Parameter	Symbol	Rating	Unit
Reverse Voltage	V_R	5	V
Forward Current	I_F	30	mA
Peak Forward Current (Duty 1/10 @1KHz)	I_{FP}	100	mA
Power Dissipation	P_d	110	mW
Junction Temperature	T_j	115	°C
Operating Temperature	T_{opr}	-40 ~ +85	°C
Storage Temperature	T_{stg}	-40 ~ +90	°C
Thermal Resistance	$R_{th\ J-A}$	500	K/W
	$R_{th\ J-S}$	300	K/W
ESD (Classification acc. AEC Q101)	ESD_{HBM}	2000	V
	ESD_{MM}	200	V
Soldering Temperature	T_{sol}	Reflow Soldering : 260 °C for 10 sec. Hand Soldering : 350 °C for 3 sec.	

Electro-Optical Characteristics (Ta=25°C)

Parameter	Symbol	Min.	Typ.	Max.	Unit	Condition
Luminous Intensity	I _v	900	-----	1800	mcd	I _F =20mA
Viewing Angle	2θ _{1/2}	-----	120	-----	deg	I _F =20mA
Peak Wavelength	λ _p	-----	518	-----	nm	I _F =20mA
Dominant Wavelength	λ _d	520	----	535	nm	I _F =20mA
Spectrum Radiation Bandwidth	Δλ	-----	35	-----	nm	I _F =20mA
Forward Voltage	V _F	2.7	----	3.7	V	I _F =20mA
Reverse Current	I _R	-----	-----	50	μA	V _R =5V

Note:

1. Tolerance of Luminous Intensity: ±11%
2. Tolerance of Dominant Wavelength: ±1nm
3. Tolerance of Forward Voltage: ±0.1V

EVERLIGHT

Bin Range of Luminous Intensity

Bin Code	Min.	Max.	Unit	Condition
V2	900	1120	mcd	I _F =20mA
W1	1120	1420		
W2	1420	1800		

Note:
Tolerance of Luminous Intensity: ±11%

Bin Range of Dominant Wavelength

Bin Code	Min.	Max.	Unit	Condition
X	520	525	nm	I _F =20mA
Y	525	530		
Z	530	535		

Note:
Tolerance of Dominant Wavelength: ±1nm

Bin Range of Forward Voltage

Bin Code	Min.	Max.	Unit	Condition
10	2.70	2.90	V	I _F =20mA
11	2.90	3.10		
12	3.10	3.30		
13	3.30	3.50		
14	3.50	3.70		

Note:
Tolerance of Forward Voltage: ±0.1V

Typical Electro-Optical Characteristics Curves

Spectrum Distribution

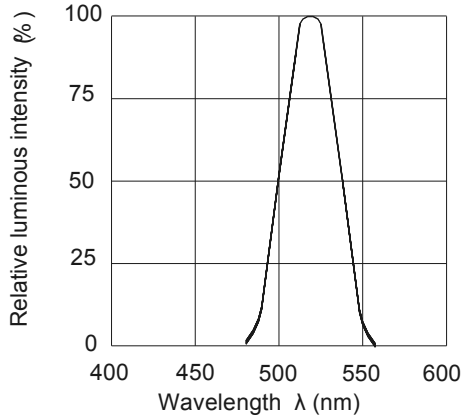

Forward Current vs. Forward Voltage

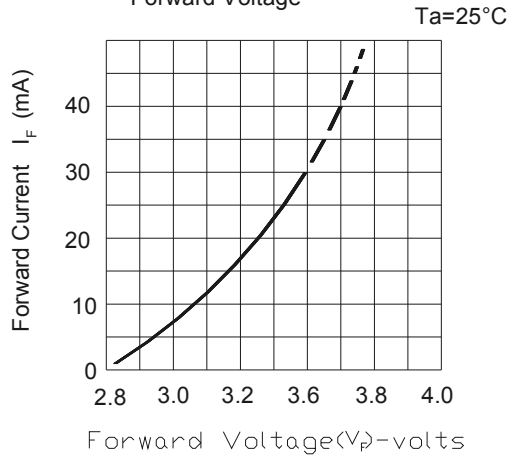

Relative Luminous Intensity vs. Ambient Temperature

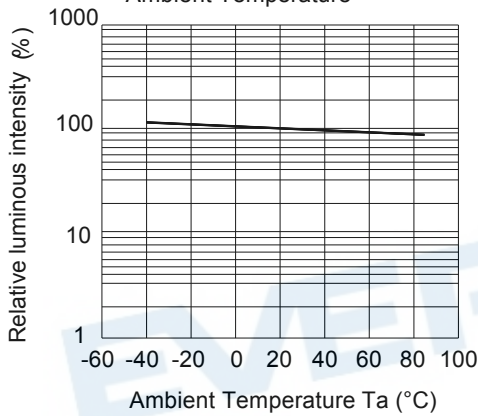

Relative Luminous Intensity vs Forward Current

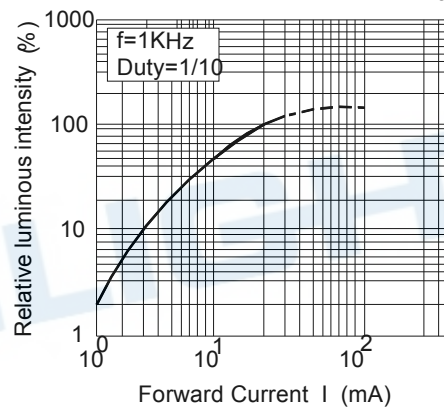

Forward Current Derating Curve

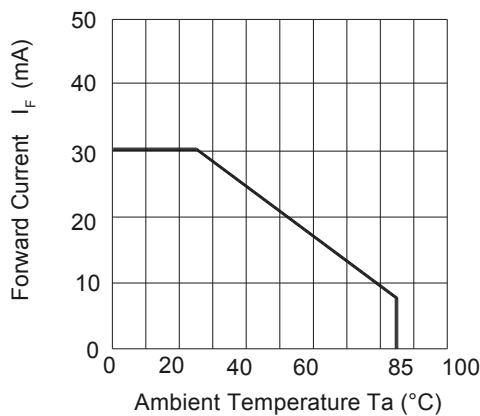

Radiation Diagram

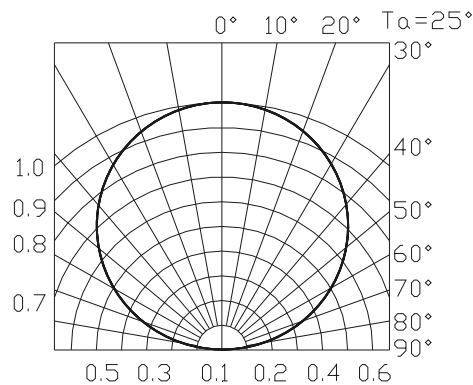

Package Dimension

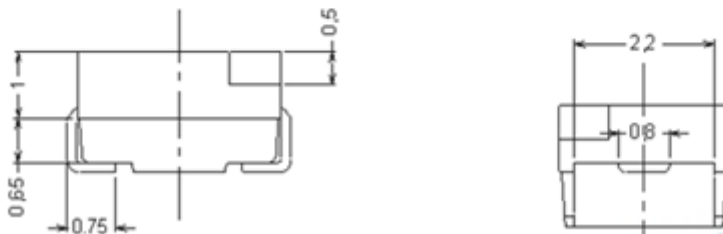
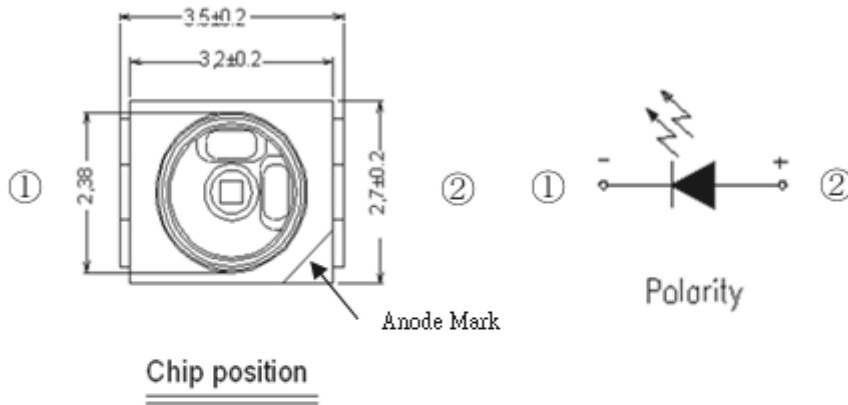

Note: Tolerances unless mentioned ± 0.1 mm. Unit = mm

EVERLIGHT

Moisture Resistant Packing Materials

Label Explanation



- CPN: Customer's Product Number
- P/N: Product Number
- QTY: Packing Quantity
- CAT: Luminous Intensity Rank
- HUE: Dom. Wavelength Rank
- REF: Forward Voltage Rank
- LOT No: Lot Number

Reel Dimensions

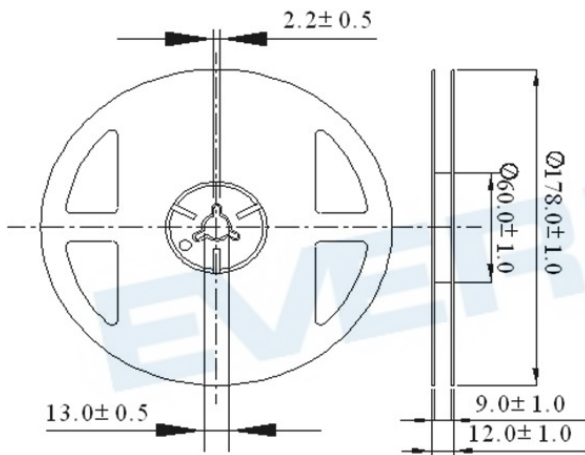

Carrier Tape Dimensions: Loaded Quantity 2000 pcs Per Reel

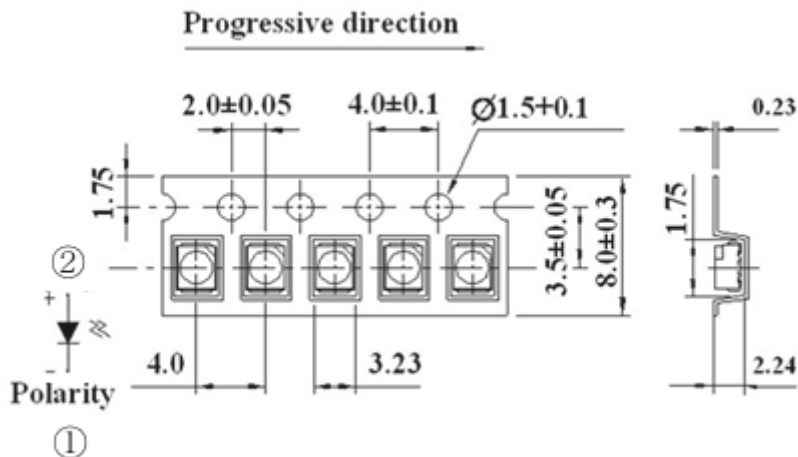

Note: Tolerances unless mentioned ±0.1mm. Unit = mm

Moisture Resistant Packing Process

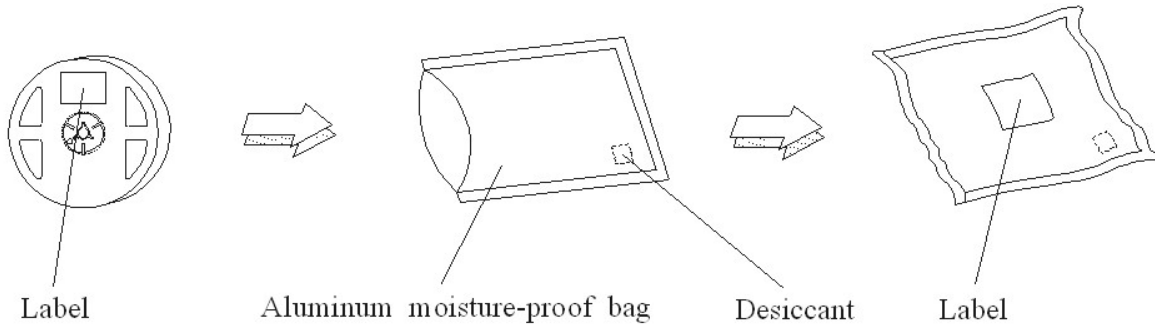

Note: Tolerances unless mentioned $\pm 0.1\text{mm}$. Unit = mm

Precautions for Use

1. Over-current-proof

1.1 Customer must apply resistors for protection, otherwise slight voltage shift will cause big current change (Burn out will happen).

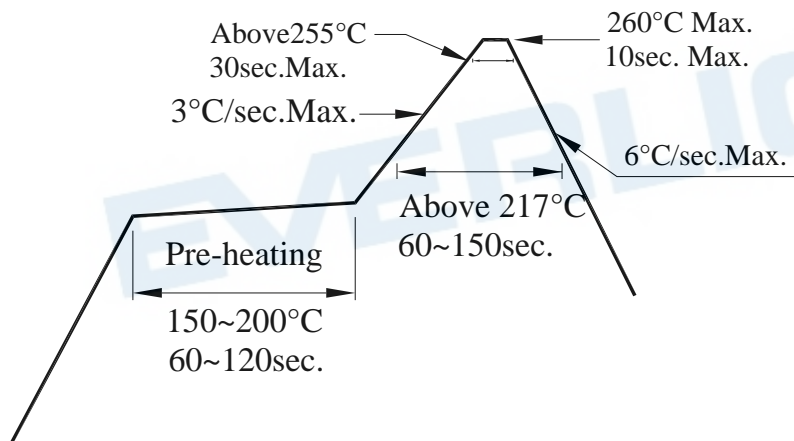

2. Storage

2.1 Moisture proof bag should only be opened immediately prior to usage.

2.2 Environment should be less than 30°C and 60% RH when moisture proof bag is opened.

2.3 After opening the package MSL Conditions stated on page 1 of this spec should not be exceeded.

2.4 If the moisture sensitivity card indicates higher than acceptable moisture, the component should be baked at min. 60deg +/-5deg for 24 hours.

3. Soldering Condition

3.1 Pb-free solder temperature profile

3.2 Reflow soldering should not be done more than two times.

3.3 When soldering, do not put stress on the LEDs during heating.

3.4 After soldering, do not warp the circuit board.

4. Soldering Iron

Each terminal is to go to the tip of soldering iron temperature less than 350°C for 3 seconds within once in less

than the soldering iron capacity 25W. Leave two seconds and more intervals, and do soldering of each terminal. Be careful because the damage of the product is often started at the time of the hand solder.

5. Repairing

Repair should not be done after the LEDs have been soldered. When repairing is unavoidable, a double-head soldering iron should be used (as below figure). It should be confirmed beforehand whether the characteristics of the LEDs will or will not be damaged by repairing.

Application Restrictions

High reliability applications such as military/aerospace, automotive safety/security systems, and medical equipment may require different product. If you have any concerns, please contact Everlight before using this product in your application. This specification guarantees the quality and performance of the product as an individual component. Do not use this product beyond the specification described in this document.

Revision History

Rev.	Modified date	File modified contents
1	2014/4/28	New Spec