

ELUA4545OG3

1.8W Series

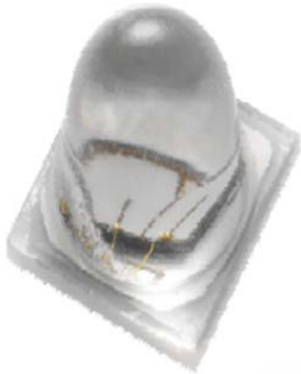

Introduction

The ELUA4545OG3 product series is a ceramic based LED with high quality and reliability that suitable for UV application.

Features

- ◆ High power UVA LED
- ◆ Dimension 4.5mm* 4.5mm* 4.5mm
- ◆ ESD protection up to 8KV
- ◆ RoHS compliant
- ◆ Pb free
- ◆ EU REACH compliant
- ◆ Halogen Free compliant
(Br<900ppm,Cl<900ppm,Br+Cl<1500ppm)

Applications

- ◆ UV Sterilization System
- ◆ UV Photo-catalyst
- ◆ UV Sensor Light

Product Nomenclature

ELUA4545OG3-PXXXXYY3241500-VD1M

EL = Everlight

UA = UVA

4545 = 4.5mm x 4.5mm Package

O = Package Material: Al₂O₃

G = Coating: Ag

3 = Angle: 30°

P = Peak Wavelength

XXXX = Wavelength Range [1]

YY = Minimum Radiant Flux Spec [2]

3241 = Forward Voltage Spec: 3.2~4.1V

500 = Forward Current: 500mA

V = Chip Type: Vertical

D = Chip Size: 45mil

1 = Chip QTY: 1 chip

M = Process Type: Molding

Notes:

1. Wavelength Range

| Symbol | Description |
|--------|-------------|
| 6070 | 360~370nm |
| 8090 | 380~390nm |
| 9000 | 390~400nm |
| 0010 | 400~410nm |
| 1020 | 410~420nm |
| 2030 | 420~430nm |
| 3040 | 430~440nm |

2. Minimum Radiant Flux Spec

| Symbol | Description |
|--------|-------------|
| U1 | 900mW |
| U2 | 1000mW |

Absolute Maximum Ratings

| Parameter | Symbol | Ratings | Unit |
|------------------------------|-----------|-----------|------|
| Max. DC Forward Current (mA) | I_F | 700 | mA |
| Max. ESD Resistance | V_B | 8000 | V |
| Max. Junction Temperature | T_J | 95 | °C |
| Operating Temperature | T_{Opr} | -40 ~ +85 | °C |
| Storage Temperature | T_{Stg} | -40 ~ +85 | °C |

PN of the ELUA4545OG3 series: UVA LEDs

UV, ELUA4545OG3 series LEDs at 500mA are listed below

| Color | Order Code of ELUA4545OG3 | Minimum Radiant Flux (mW) | Peak Wavelength (nm) | Forward Voltage (V) |
|-------------|---------------------------------|---------------------------|----------------------|---------------------|
| Ultraviolet | ELUA4545OG3-P6070U13241500-VD1M | 900 | 360~370 | 3.2~4.1 |
| | ELUA4545OG3-P8090U23241500-VD1M | 1000 | 380~390 | 3.2~4.1 |
| | ELUA4545OG3-P9000U23241500-VD1M | 1000 | 390~400 | 3.2~4.1 |
| | ELUA4545OG3-P0010U23241500-VD1M | 1000 | 400~410 | 3.2~4.1 |
| | ELUA4545OG3-P1020U23241500-VD1M | 1000 | 410~420 | 3.2~4.1 |
| | ELUA4545OG3-P2030U23241500-VD1M | 1000 | 420~430 | 3.2~4.1 |
| | ELUA4545OG3-P3040U23241500-VD1M | 1000 | 430~440 | 3.2~4.1 |

Product Binning Radiant Flux Bins

| Bin Code | Minimum Radiant Flux (mW) | Maximum Radiant Flux (mW) |
|----------|---------------------------|---------------------------|
| U1 | 900 | 1000 |
| U2 | 1000 | 1100 |
| U3 | 1100 | 1200 |
| U4 | 1200 | 1300 |
| U5 | 1300 | 1400 |
| U6 | 1400 | 1500 |
| U7 | 1500 | 1600 |

Notes:

- 1.Radiant flux measurement tolerance: $\pm 10\%$.
- 2.Forward voltage bins are defined at $I_F=500\text{mA}$ operation.

Peak Wavelength Bins

| Group | Bin | Minimum Peak Wavelength (nm) | Maximum Peak Wavelength (nm) |
|-------|-----|------------------------------|------------------------------|
| U | 36 | 360 | 370 |
| | 38 | 380 | 390 |
| | 39 | 390 | 400 |
| | 40 | 400 | 410 |
| | 41 | 410 | 420 |
| | 42 | 420 | 430 |
| | 43 | 430 | 440 |

Notes:

- 1.Peak Wavelength measurement tolerance: $\pm 1\text{nm}$.
- 2.Forward voltage bins are defined at $I_F=500\text{mA}$ operation.

Forward Voltage Bins

| Bin | Minimum Forward Voltage (V) | Maximum Forward Voltage (V) |
|------|-----------------------------|-----------------------------|
| 3235 | 3.2 | 3.5 |
| 3538 | 3.5 | 3.8 |
| 3841 | 3.8 | 4.1 |

Notes:

- 1.Forward voltage measurement tolerance: $\pm 2\%$.
- 2.Forward voltage bins are defined at $I_F=500\text{mA}$ operation.

Mechanical Dimension

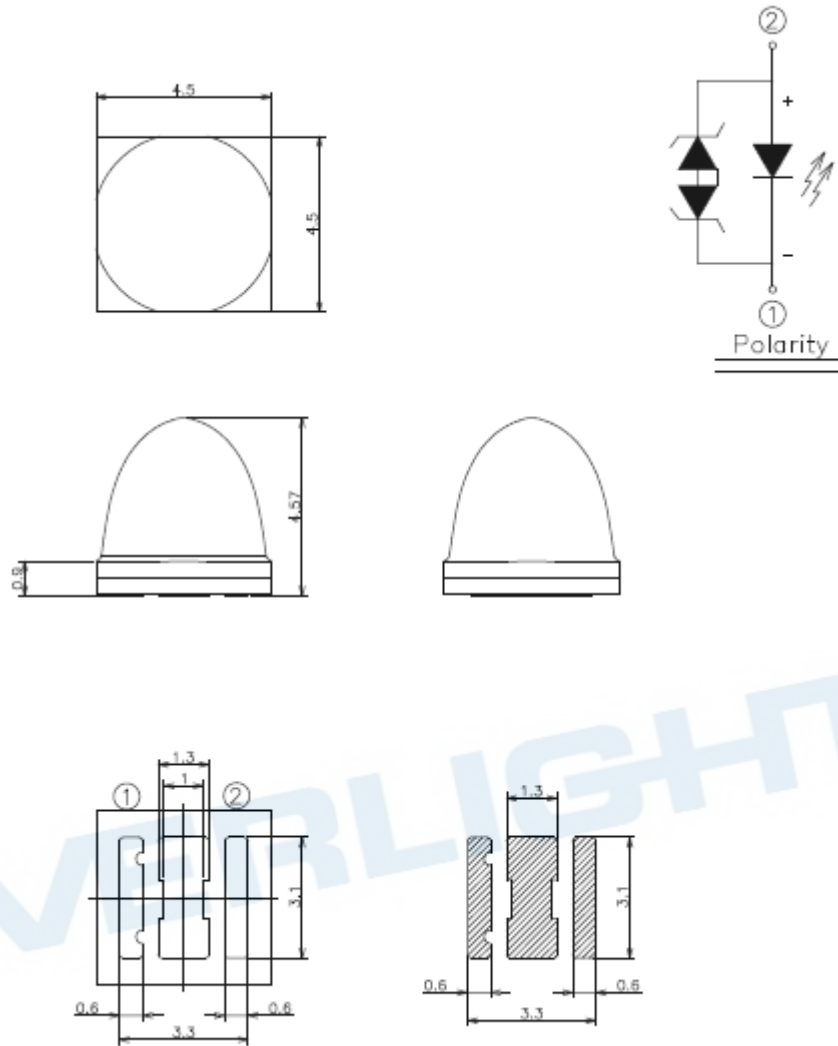

1. Dimensions are in millimeters.
2. Tolerances unless mentioned are $\pm 0.1\text{mm}$

Pad Configuration

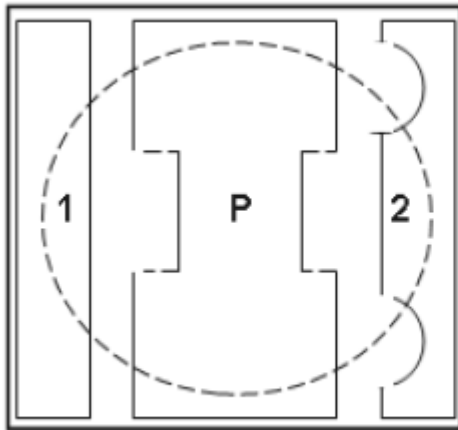

BOTTOM VIEW

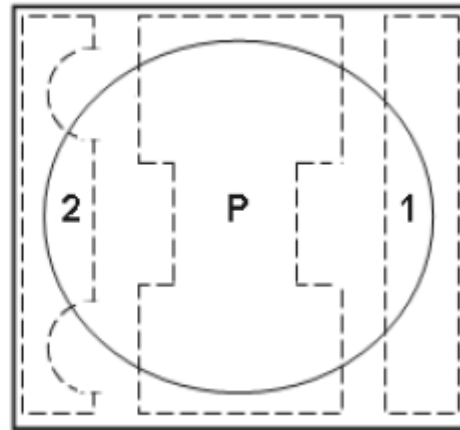

TOP VIEW

| PAD | FUNCTION |
|-----|-------------|
| 1 | ANODE |
| 2 | CATHODE |
| P | THERMAL PAD |

Reflow Soldering Characteristics

For Reflow Process

- ELUA series are suitable for SMT processes.
- Curing of glue in oven must be according to standard operation flow processes.

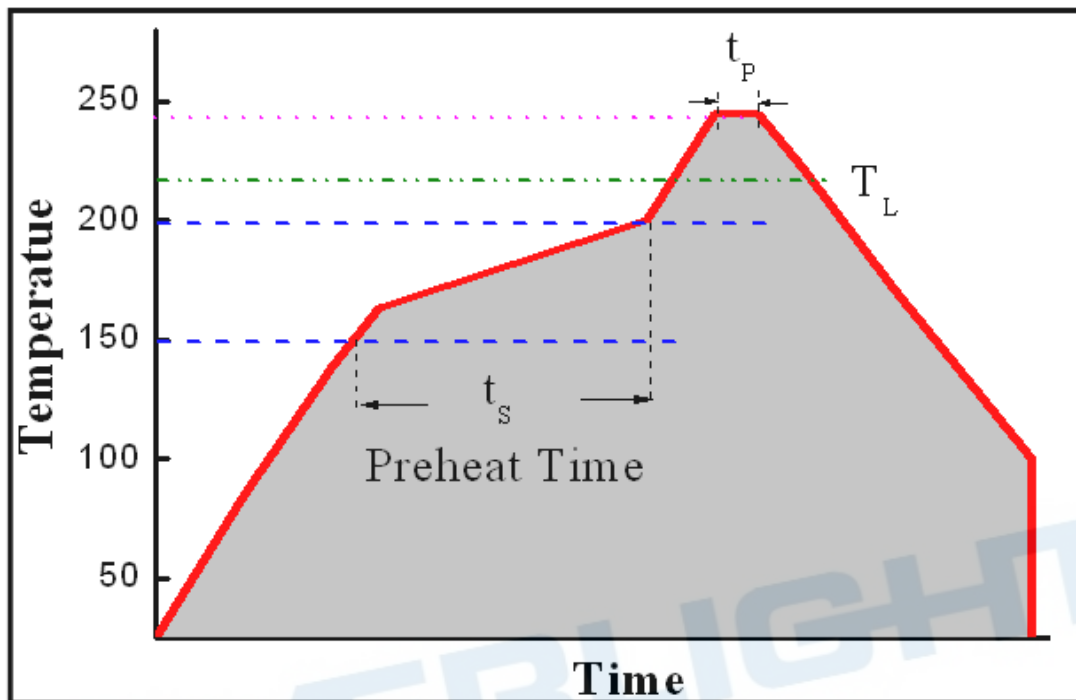

| Profile Feature | Lead Free Assembly |
|------------------------------|--------------------|
| Ramp-Up Rate | 2-3 °C/S |
| Preheat Temperature | 150-200 °C |
| Preheat Time (t_s) | 60-120 S |
| Liquid Temperature (T_L) | 217 °C |
| Time maintained above T_L | 60-90 S |
| Peak Temperature (T_p) | 240±5 °C |
| Peak Time (t_p) | Max 20 S |
| Ramp-Down Rate | 3-5 °C/S |

- Reflow soldering should not be done more than twice.
- In soldering process, stress on the LEDs during heating should be avoided.
- After soldering, do not bend the circuit board.

Typical Characteristics Curves

Spectrum @ Thermal Pad Temperature = 25°C

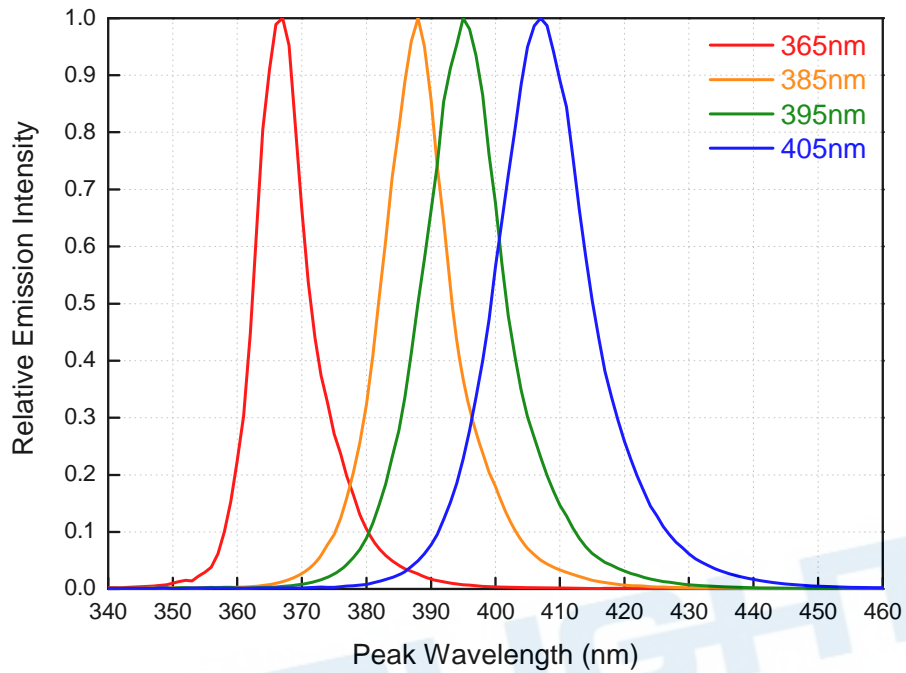

Relative Radiant Flux vs. Forward Current
@ Thermal Pad Temperature = 25°C

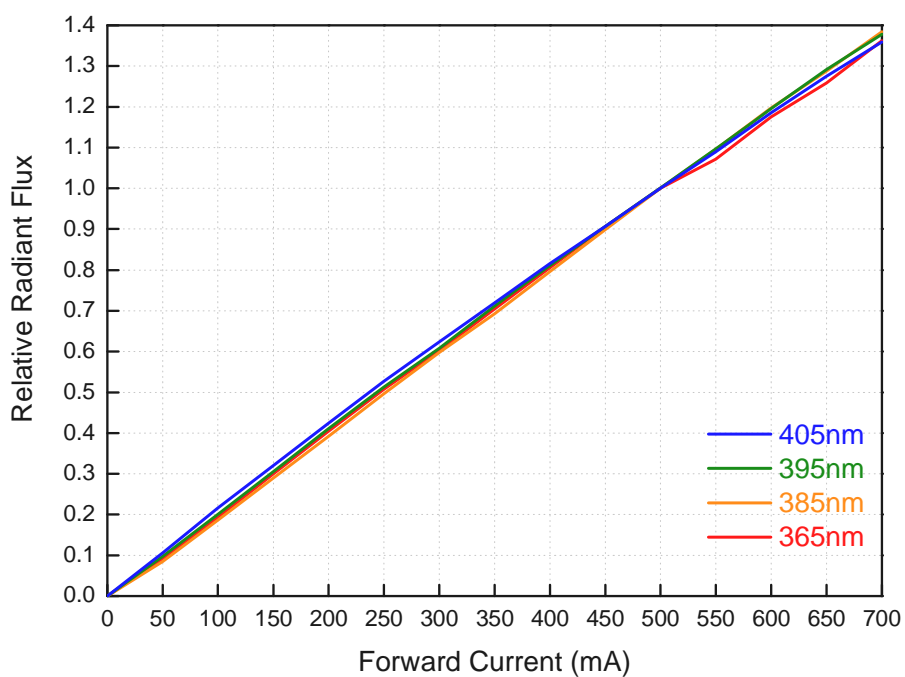

Peak Wavelength vs. Forward Current

@ Thermal Pad Temperature = 25°C

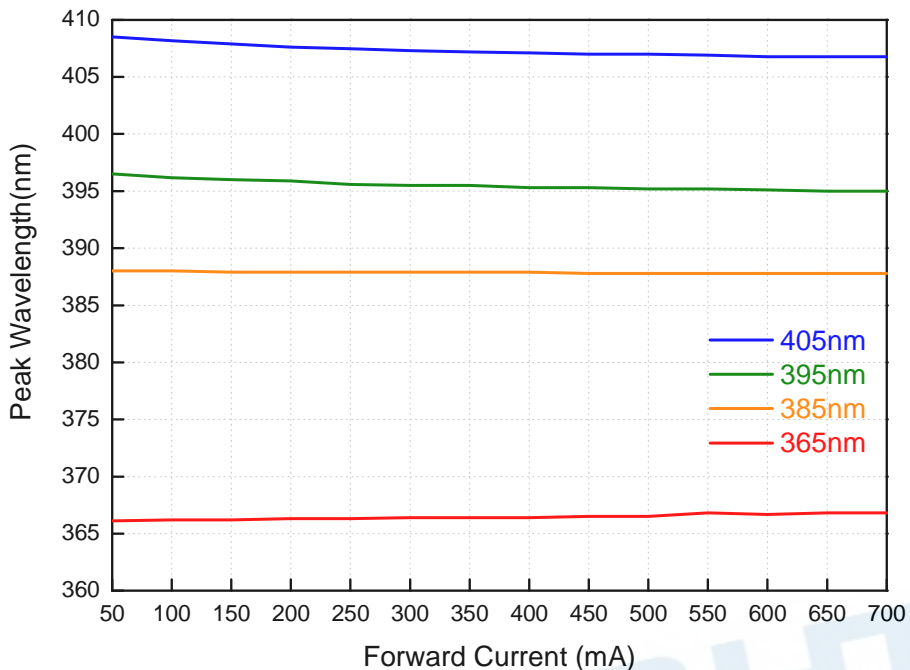

Forward Voltage vs. Forward Current

@ Thermal Pad Temperature = 25°C

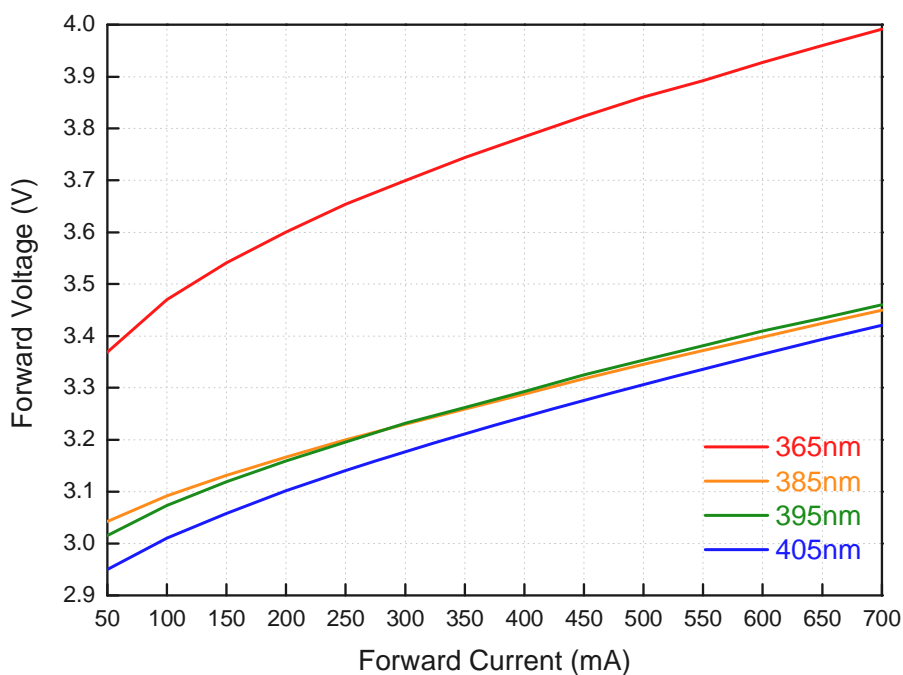

Relative Radiant Flux vs. Ambient Temperature @ Forward Current = 500mA

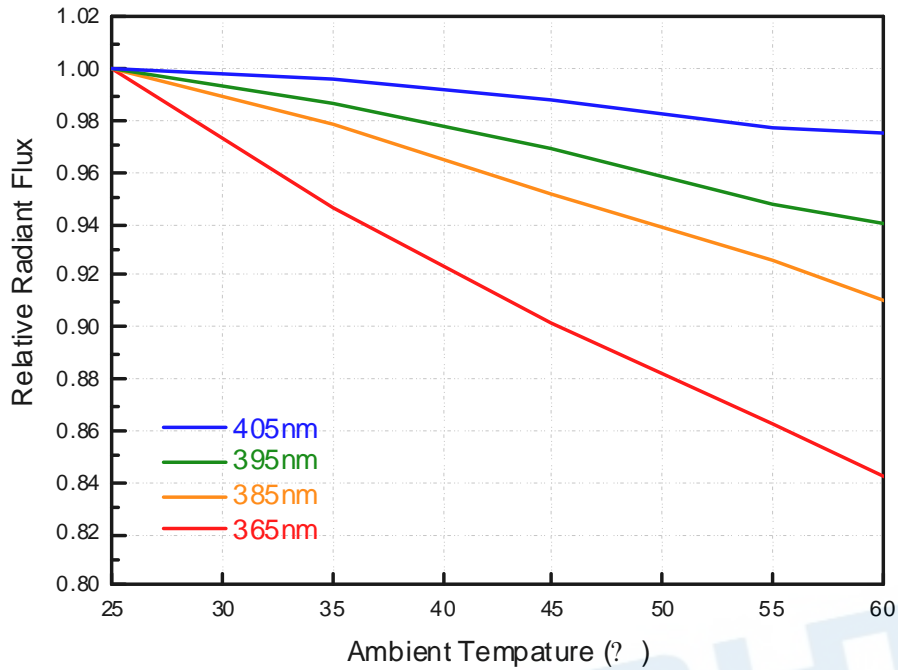

Peak Wavelength vs. Ambient Temperature @ Forward Current = 500mA

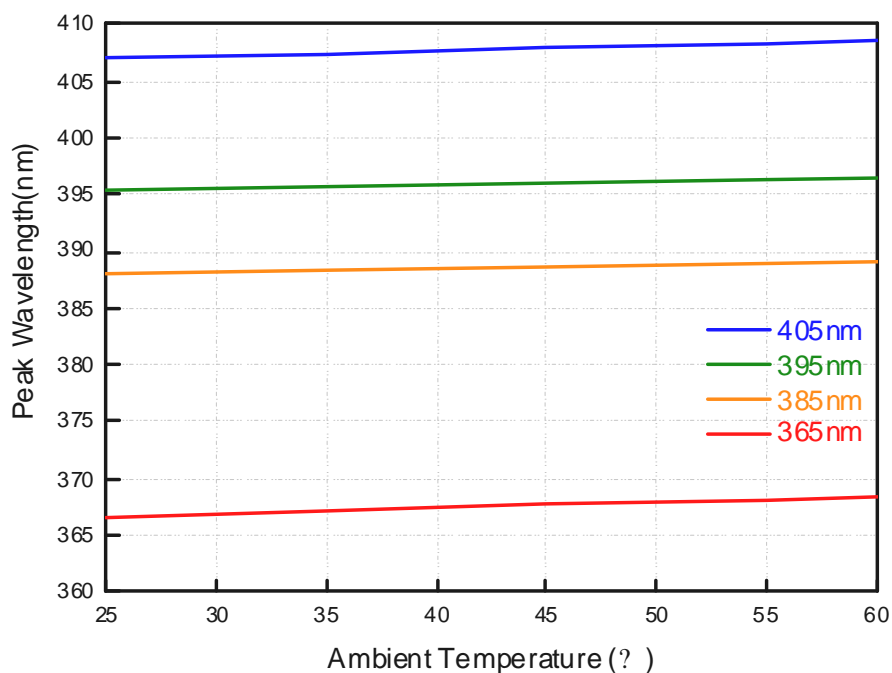

Forward Voltage vs. Ambient Temperature @ Forward Current = 500mA

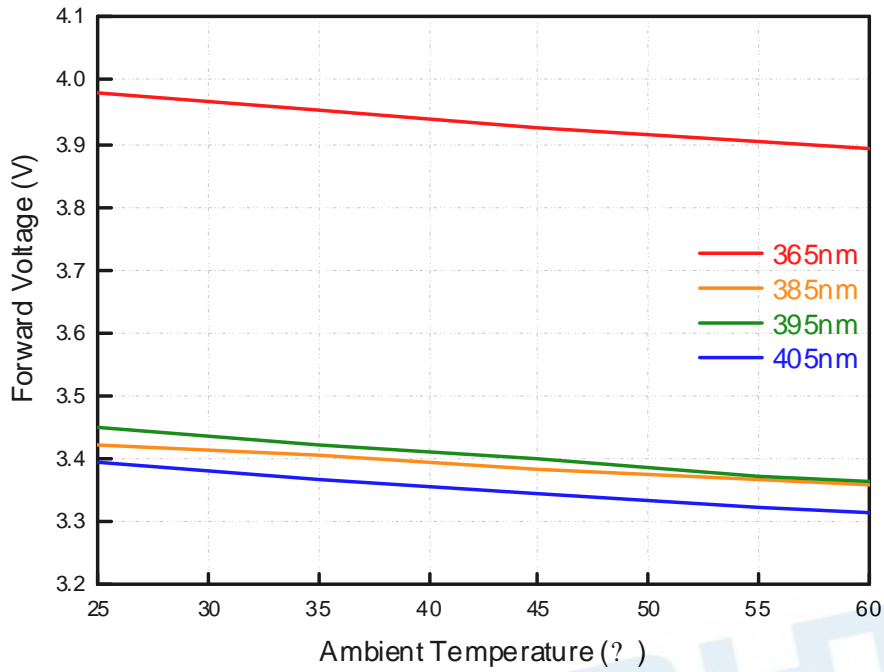

Derating Curve

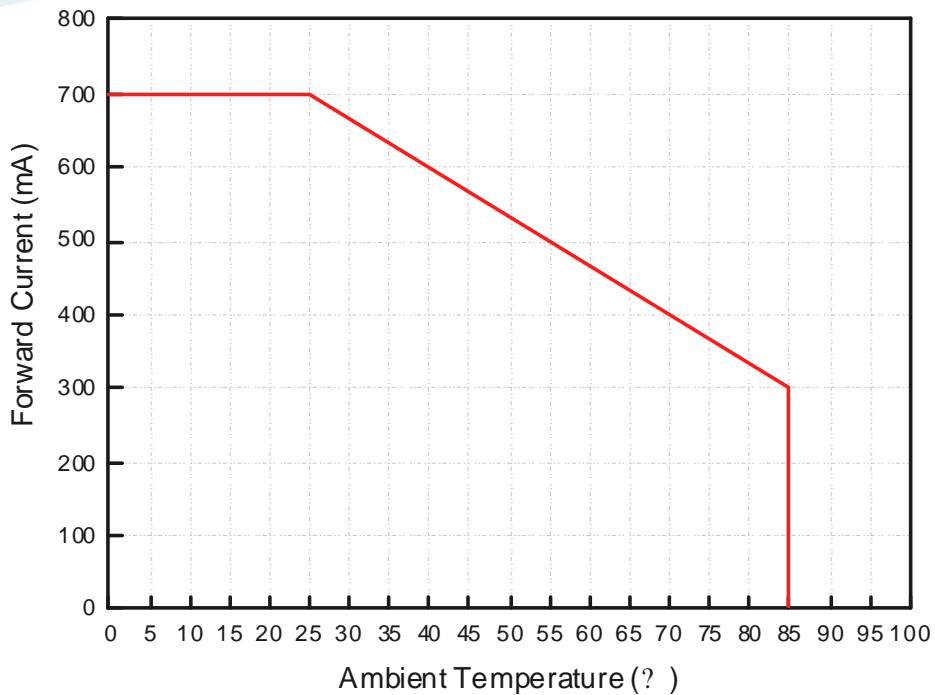

Typical Radiation Patterns

Typical Diagram Characteristics of Radiation for ELUA4545OG3

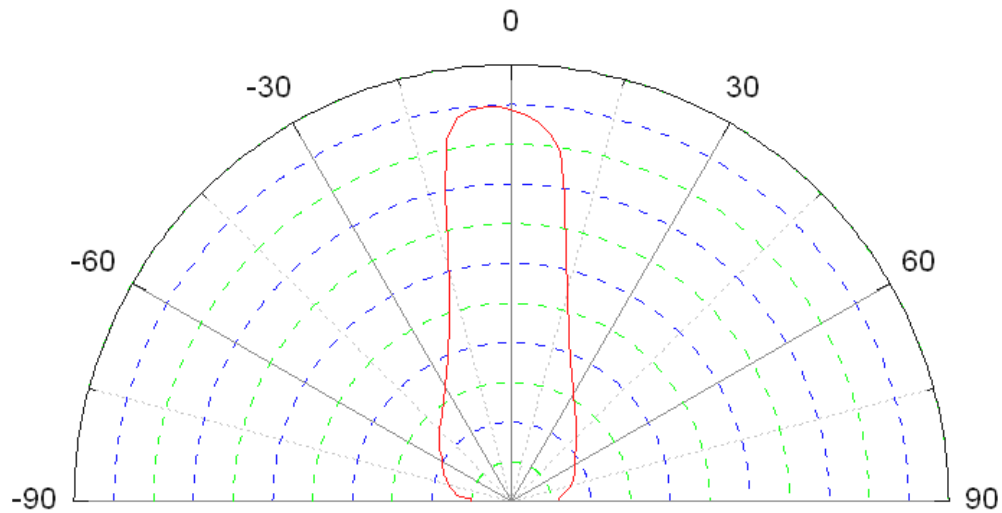

Notes:

1. $2\theta_{1/2}$ is the off axis angle from lamp centerline where the luminous intensity is 1/2 of the peak value.
2. View angle tolerance is $\pm 5^\circ$.

EVERLIGHT

Emitter Tape Packaging

Carrier Tape Dimensions as the following:

Reel: 250pcs

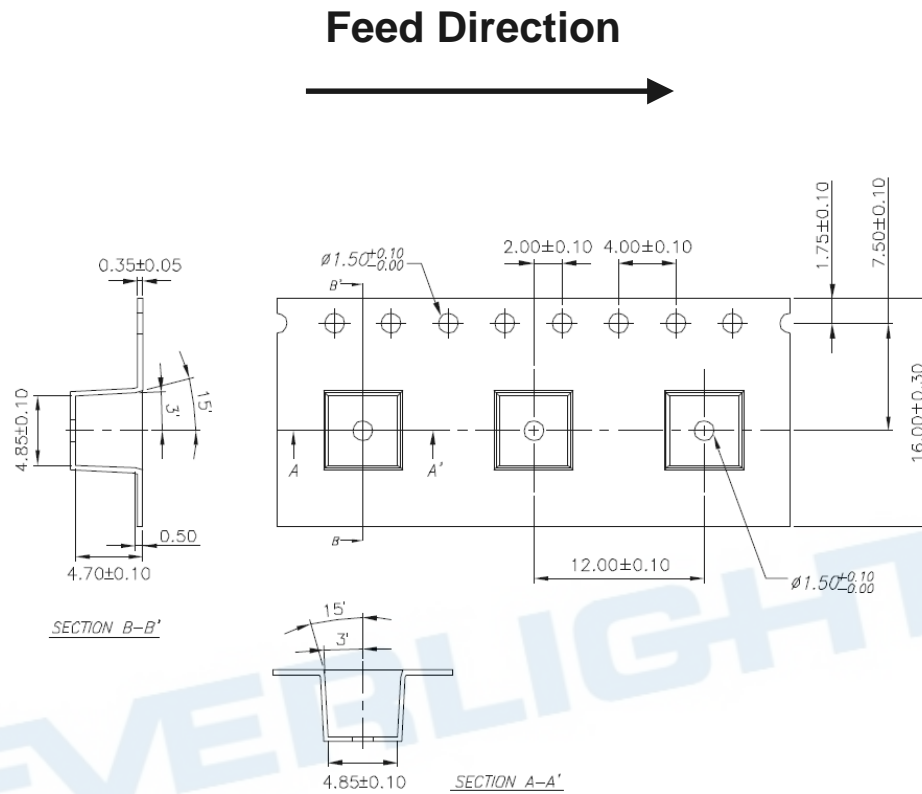

Notes:

1. Tolerance unless mentioned is $\pm 0.1\text{mm}$; Unit = mm
2. Packing amount is 50/100/150/200/250 pcs per reel

Moisture Resistant Packaging

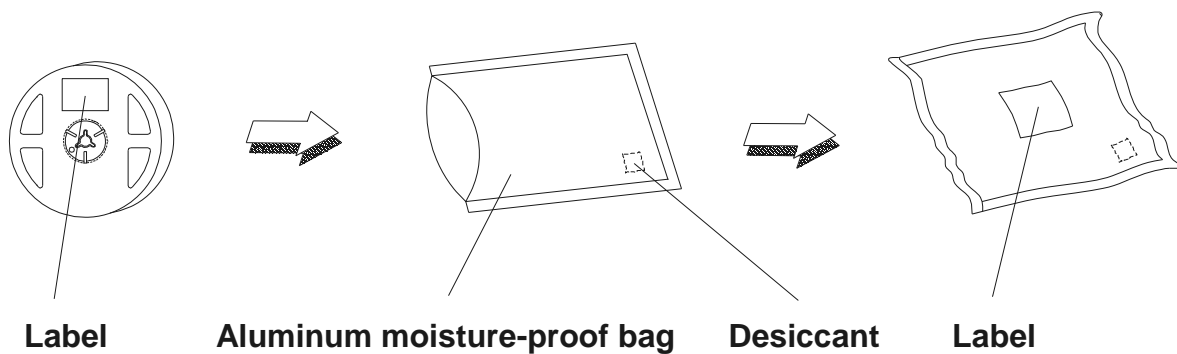

Emitter Reel Packaging

Reel Dimensions

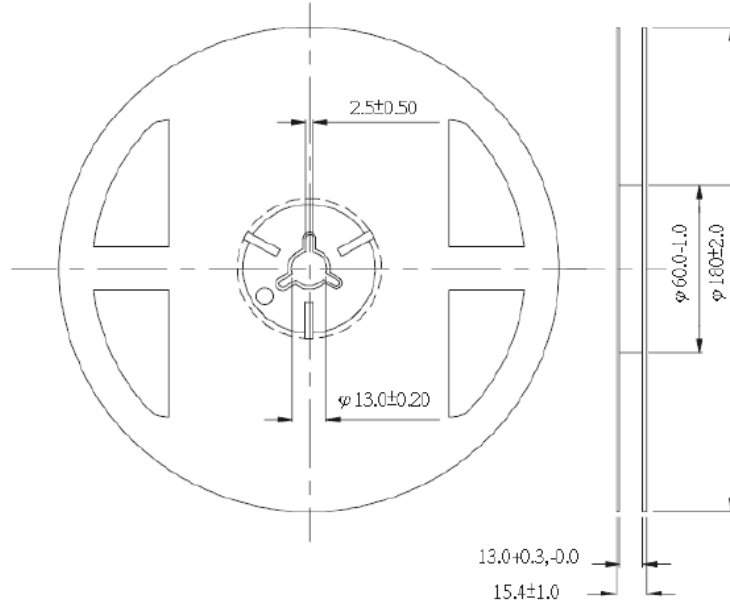

Notes:

1. Dimensions are in millimeters.
2. Tolerances unless mentioned are $\pm 0.1\text{mm}$.

Product Labeling

Label Explanation

CPN: Customer Specification (when required)

P/N : Everlight Production Number

QTY: Packing Quantity

CAT: Luminous Flux (Brightness) Bin

HUE: Color Bin

REF: Forward Voltage Bin

LOT No: Lot Number

MADE IN TAIWAN: Production Place

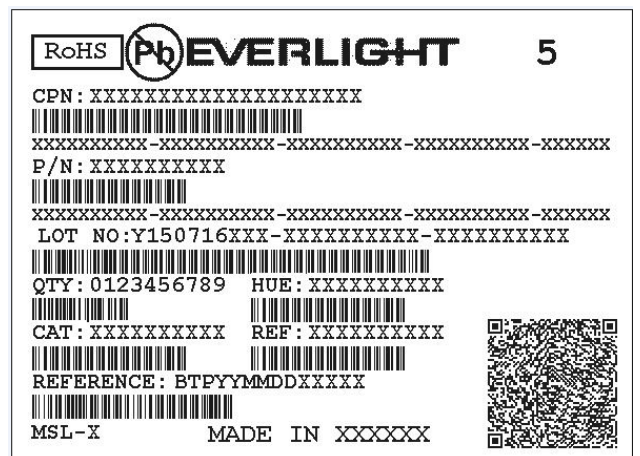

Storage Conditions

- Before the package is opened. The LEDs should be stored at 30°C or less and 90%RH or less after being shipped from EVERLIGHT and the storage life limits are 12 months.
- After opening the package: The LED's floor life is unlimited under 30°C or less and 85% RH or less. If unused LEDs remain, it should be stored in moisture proof packages.
- If the moisture absorbent material (silica gel) has faded away or the LEDs have exceeded the storage time, baking treatment should be performed using the following conditions. Baking treatment: 60±5°C for 24 hours.

Disclaimer

- EVERLIGHT reserves the right(s) on the adjustment of product material mix for the specification.
- The product meets EVERLIGHT published specification for a period of twelve (12) months from date of shipment.
- The graphs shown in this datasheet are representing typical data only and do not show guaranteed values.
- When using this product, please observe the absolute maximum ratings and the instructions for using outlined in these specification sheets. EVERLIGHT assumes no responsibility for any damage resulting from the use of the product which does not comply with the absolute maximum ratings and the instructions included in these specification sheets.
- These specification sheets include materials protected under copyright of EVERLIGHT. Reproduction in any form is prohibited without obtaining EVERLIGHT's prior consent.
- This product is not intended to be used for military, aircraft, automotive, medical, life sustaining or life saving applications or any other application which can result in human injury or death. Please contact authorized EVERLIGHT sales agent for special application request.