

SMD ■ Power Top View LED EAPL3527BA5



Features

- P-LCC-3 package.
- High flux output.
- High current capability.
- White package.
- Optical indicator.
- Colorless clear window.
- Ideal for backlight and light pipe application.
- Inter reflector.
- Wide viewing angle.
- Suitable for automatic placement equipment.
- Suitable for reflow and wave solder processes.
- Available on tape and reel (8mm Tape).
- Pb-free.
- The product itself will remain within RoHS compliant version.

Descriptions

- The 67-31A series is available in soft orange, red and yellow. Due to the package design, the LED has wide viewing angle and optimized light coupling by inter reflector.
- This feature makes the ideal for light pipe application. The low current requirement makes this device ideal for portable equipment or any other application where power is at a premium.

Applications

- Indicator and backlight for audio and video equipment.
- Indicator and backlight in office and family equipment.
- Flat backlight for LCD's, switches and symbols.
- Light pipe application.

Device Selection Guide

Chip Materials	Emitted Color	Resin Color
InGaN	Blue	Water Clear

Absolute Maximum Ratings (Ta=25°C)

Parameter	Symbol	Rating	Unit
Reverse Voltage	V_R	5	V
Forward Current	I_F	30	mA
Peak Forward Current (Duty 1/10 @1KHz)	I_{FP}	100	mA
Power Dissipation	P_d	95	mW
Junction Temperature	T_j	115	°C
Operating Temperature	T_{opr}	-40 ~ +85	°C
Storage Temperature	T_{stg}	-40 ~ +90	°C
Thermal Resistance	$R_{th\ J-A}$	600	K/W
	$R_{th\ J-S}$	400	K/W
ESD (Classification acc. AEC Q101)	ESD_{HBM}	2000	V
	ESD_{MM}	200	V
Soldering Temperature	T_{sol}	Reflow Soldering : 260 °C for 10 sec. Hand Soldering : 350 °C for 3 sec.	

Electro-Optical Characteristics (Ta=25°C)

Parameter	Symbol	Min.	Typ.	Max.	Unit	Condition
Luminous Intensity	I _v	285	-----	715	mcd	I _F =30mA
Viewing Angle	2θ _{1/2}	-----	120	-----	deg	I _F =30mA
Peak Wavelength	λ _p	-----	468	-----	nm	I _F =30mA
Dominant Wavelength	λ _d	464.5	----	476.5	nm	I _F =30mA
Spectrum Radiation Bandwidth	Δλ	-----	35	-----	nm	I _F =30mA
Forward Voltage	V _F	2.75	----	3.95	V	I _F =30mA
Reverse Current	I _R	-----	-----	50	μA	V _R =5V

Note:

1. Tolerance of Luminous Intensity: ±11%
2. Tolerance of Dominant Wavelength: ±1nm
3. Tolerance of Forward Voltage: ±0.1V

EVERLIGHT

Bin Range of Luminous Intensity

Bin Code	Min.	Max.	Unit	Condition
T1	285	360	mcd	I _F =30mA
T2	360	450		
U1	450	565		
U2	565	715		

Note:
Tolerance of Luminous Intensity: ±11%

Bin Range of Dominant Wavelength

Bin Code	Min.	Max.	Unit	Condition
A9	464.5	467.5	nm	I _F =30mA
A10	467.5	470.5		
A11	470.5	473.5		
A12	473.5	476.5		

Note:
Tolerance of Dominant Wavelength: ±1nm

Bin Range of Forward Voltage

Bin Code	Min.	Max.	Unit	Condition
5	2.75	3.05	V	I _F =30mA
6	3.05	3.35		
7	3.35	3.65		
8	3.65	3.95		

Note:
Tolerance of Forward Voltage: ±0.1V

Typical Electro-Optical Characteristics Curves

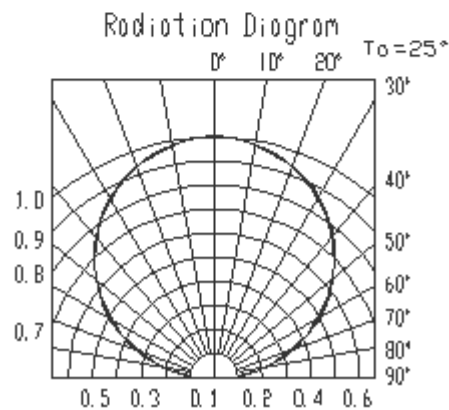
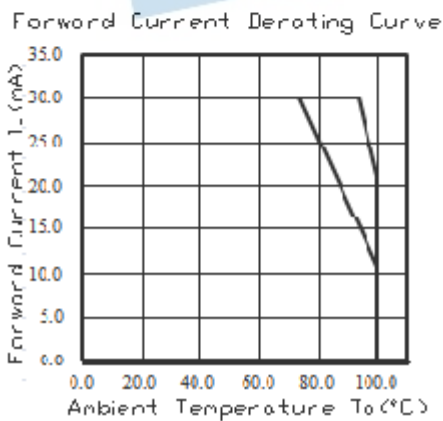
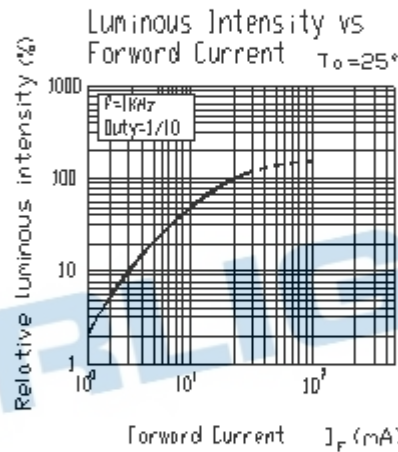
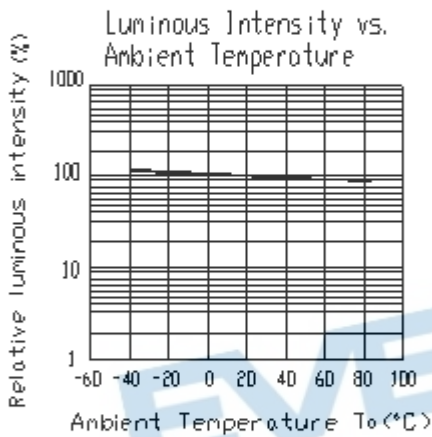
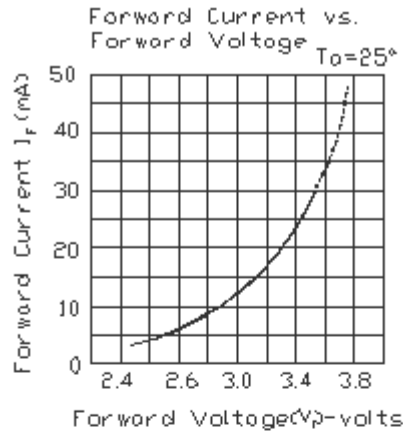
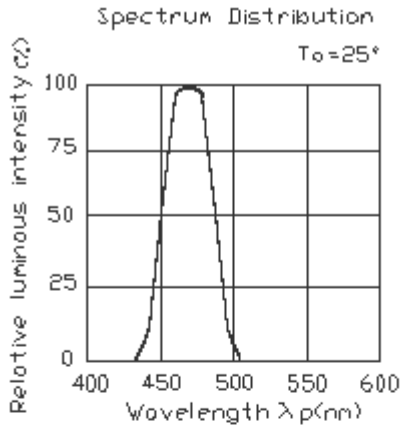

Package Dimension

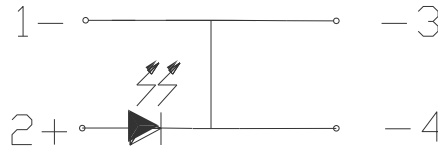
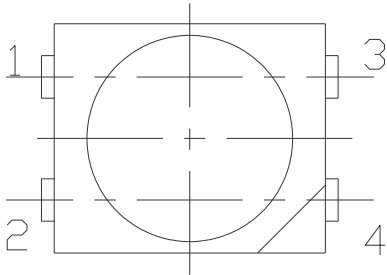

Polarity

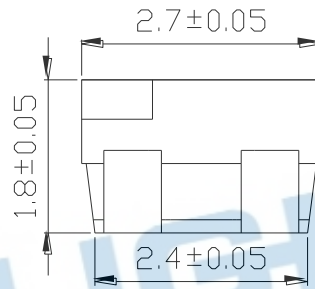
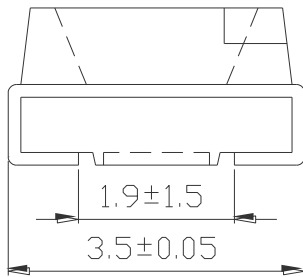

Recommended soldering pad design

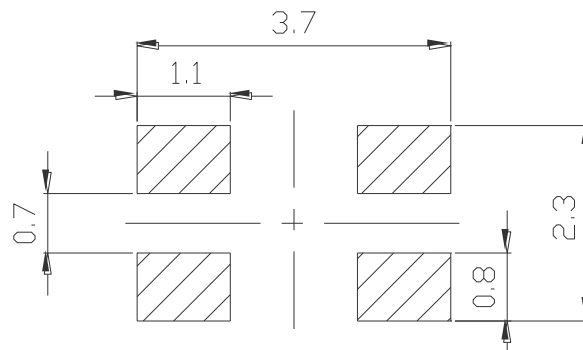
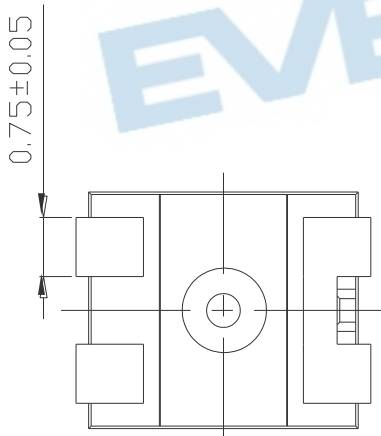

Note: Tolerances unless mentioned ± 0.1 mm. Unit = mm

Moisture Resistant Packing Materials

Label Explanation



- CPN: Customer's Product Number
- P/N: Product Number
- QTY: Packing Quantity
- CAT: Luminous Intensity Rank
- HUE: Dom. Wavelength Rank
- REF: Forward Voltage Rank
- LOT No: Lot Number

Reel Dimensions

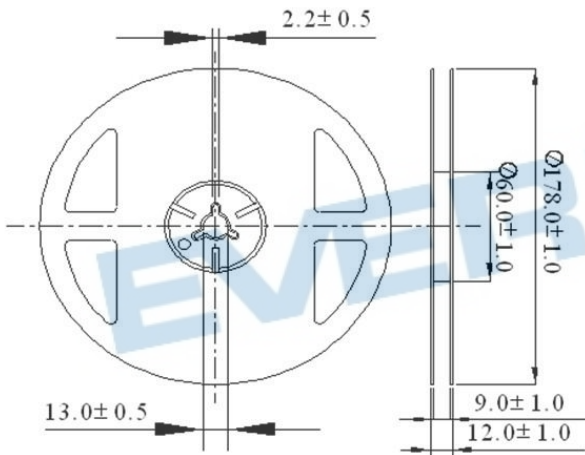

Carrier Tape Dimensions: Loaded Quantity 2000 pcs Per Reel

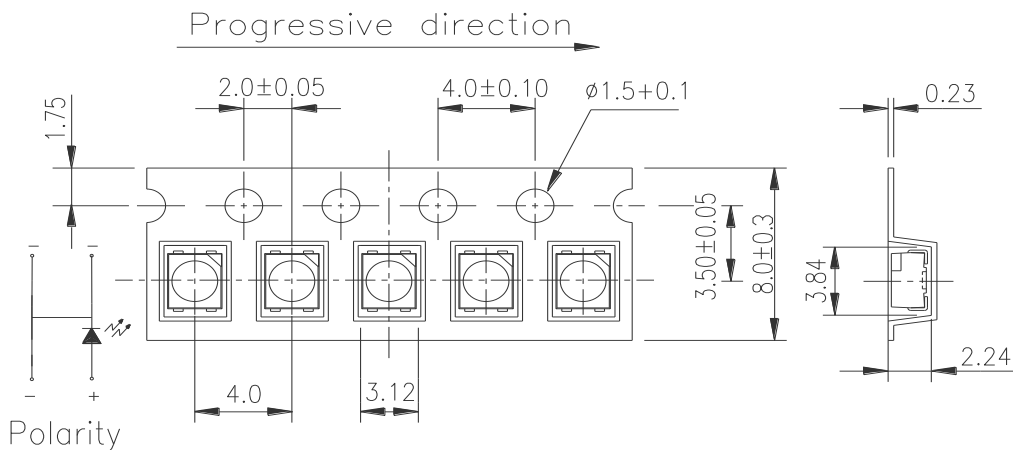

Note: Tolerances unless mentioned $\pm 0.1\text{mm}$. Unit = mm

Moisture Resistant Packing Process

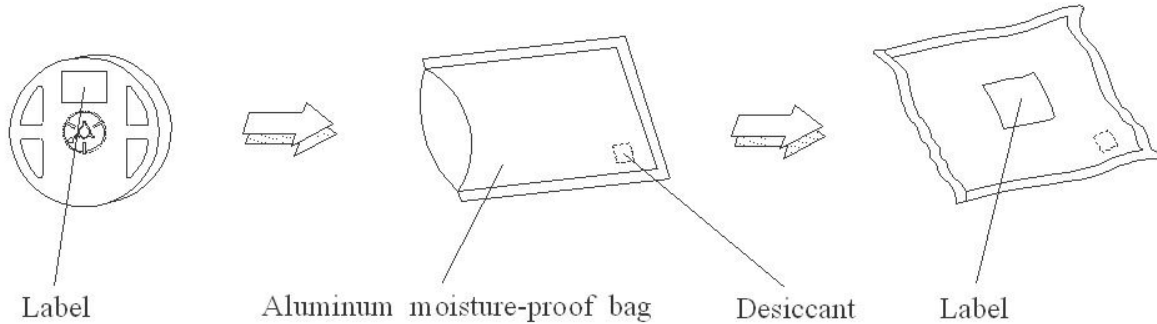

Note: Tolerances unless mentioned $\pm 0.1\text{mm}$. Unit = mm

Precautions for Use

1. Over-current-proof

1.1 Customer must apply resistors for protection, otherwise slight voltage shift will cause big current change (Burn out will happen).

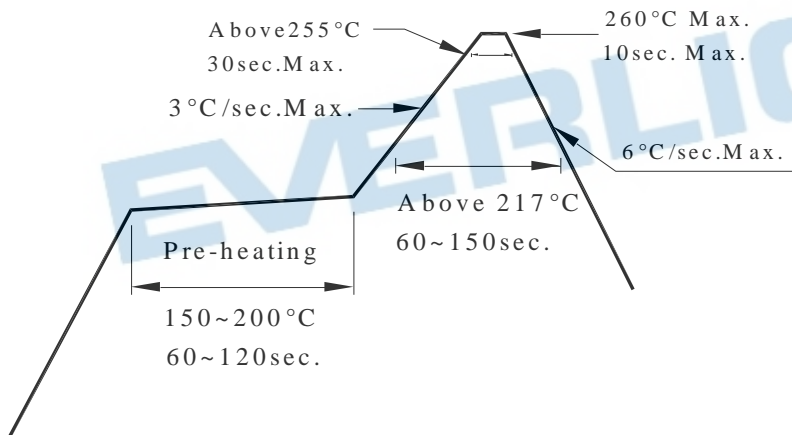

2. Storage

- 2.1 Moisture proof bag should only be opened immediately prior to usage.
- 2.2 Environment should be less than 30°C and 60% RH when moisture proof bag is opened.
- 2.3 After opening the package MSL Conditions stated on page 1 of this spec should not be exceeded.
- 2.4 If the moisture sensitivity card indicates higher than acceptable moisture, the component should be baked at min. 60deg +/-5deg for 24 hours.

3. Soldering Condition

- 3.1 Pb-free solder temperature profile
- 3.2 Reflow soldering should not be done more than two times.
- 3.3 When soldering, do not put stress on the LEDs during heating.
- 3.4 After soldering, do not warp the circuit board.

4. Soldering Iron

Each terminal is to go to the tip of soldering iron temperature less than 350°C for 3 seconds within once in less than the soldering iron capacity 25W. Leave two seconds and more intervals, and do soldering of each terminal. Be careful because the damage of the product is often started at the time of the hand solder.

5. Repairing

Repair should not be done after the LEDs have been soldered. When repairing is unavoidable, a double-head soldering iron should be used (as below figure). It should be confirmed beforehand whether the characteristics of the LEDs will or will not be damaged by repairing.

Application Restrictions

High reliability applications such as military/aerospace, automotive safety/security systems, and medical equipment may require different product. If you have any concerns, please contact Everlight before using this product in your application. This specification guarantees the quality and performance of the product as an individual component. Do not use this product beyond the specification described in this document.

Revision History

Rev.	Modified date	File modified contents
1	2014/4/30	New Spec