

### SMD ■ Side View LEDs

### EAPL3810A8



#### Features

- . Side view white LED.
- . White SMT package.
- . Lead frame package with individual 2 pins.
- . Wide viewing angle
- . Soldering methods: IR reflow soldering
- . Pb-free
- . The product itself will remain within RoHS compliant version.
- . Compliance with EU REACH.
- . Compliance Halogen Free .(Br <900 ppm ,Cl <900 ppm , Br+Cl < 1500 ppm).

#### Description

Due to the package design, EAPL3810A8 has wide viewing angle, low power consumption and white LEDs are devices which are materialized by combing blue chips and special phosphor. This feature makes the LED ideal for light guide application.

#### Applications

- . LCD back light.
- . Mobile phones.
- . Indicators.
- . Illuminations.
- . Switch lights.

## Device Selection Guide

Chip Materials	Emitted Color	Resin Color
InGaN	Pure White	Water Clear

## Absolute Maximum Ratings (Ta=25°C)

Parameter	Symbol	Rating	Unit
Reverse Voltage	$V_R$	5	V
Forward Current	$I_F$	30	mA
Peak Forward Current (Duty 1/10 @10ms)	$I_{FP}$	60	mA
Power Dissipation	$P_d$	110	mW
Operating Temperature	$T_{opr}$	-40 ~ +85	°C
Storage Temperature	$T_{stg}$	-40 ~ +90	°C
Soldering Temperature	$T_{sol}$	Reflow Soldering : 260 °C for 10 sec. Hand Soldering : 350 °C for 3 sec.	

Notes: \*1The products are sensitive to static electricity and must be carefully taken when handling products.

### Electro-Optical Characteristics (Ta=25°C)

Parameter	Symbol	Min.	Typ.	Max.	Unit	Condition
Luminous Flux	$\Phi$	7.00	-----	7.75	lm	I <sub>F</sub> =20mA
Forward Voltage	V <sub>F</sub>	2.70	-----	3.00	volt	I <sub>F</sub> =20mA
Viewing Angle	2 $\theta_{1/2}$	-----	120	-----	deg	I <sub>F</sub> =20mA
Reverse Current	I <sub>R</sub>	-----	-----	50	μA	V <sub>R</sub> =5V

Notes:

1. Tolerance of Luminous Flux: ±7%.
2. Tolerance of Forward Voltage: ±0.05V.

### Bin Range of Luminous Flux

Bin Code	Min.	Max.	Unit	Condition	Min.	Max
70	7.00	7.25			2505	2595
72	7.25	7.50	lm	I <sub>F</sub> =20mA	2595	2685
75	7.50	7.75			2685	2775

Notes: Tolerance of Luminous Flux: ±7%

### Bin Range of Forward Voltage

Bin Code	Min.	Max.	Unit	Condition
4-2-3	2.70	2.80	volt	I <sub>f</sub> =20mA
5-1-3	2.80	2.90		
5-2-3	2.90	3.00		

Note: Tolerance of Forward Voltage: ±0.05V

### Bin Range of Chromaticity Coordinate

Bin Code	CIE_x	CIE_y	Bin Code	CIE_x	CIE_y
NA0-4-1	0.2850	0.2670	NA0-4-2	0.2893	0.2743
	0.2820	0.2720		0.2865	0.2795
	0.2865	0.2795		0.2910	0.2870
NA0-4-3	0.2893	0.2743	NA0-4-4	0.2935	0.2815
	0.2880	0.2620		0.2920	0.2690
	0.2850	0.2670		0.2893	0.2743
NB-5-3-1	0.2893	0.2743	NB-5-3-2	0.2935	0.2815
	0.2920	0.2690		0.2960	0.2760
	0.2935	0.2815		0.2975	0.2885
NB-5-3-3	0.2910	0.2870	NB-5-3-4	0.2950	0.2940
	0.2950	0.2940		0.2990	0.3010
	0.2975	0.2885		0.3015	0.2955
NB-5-3-3	0.2960	0.2760	NB-5-3-4	0.3000	0.2830
	0.2935	0.2815		0.2975	0.2885
	0.2975	0.2885		0.3015	0.2955
	0.3000	0.2830		0.3040	0.2900

Notes: Tolerance of Chromaticity Coordinates: ±0.005.

### The C.I.E. 1931 Chromaticity Diagram

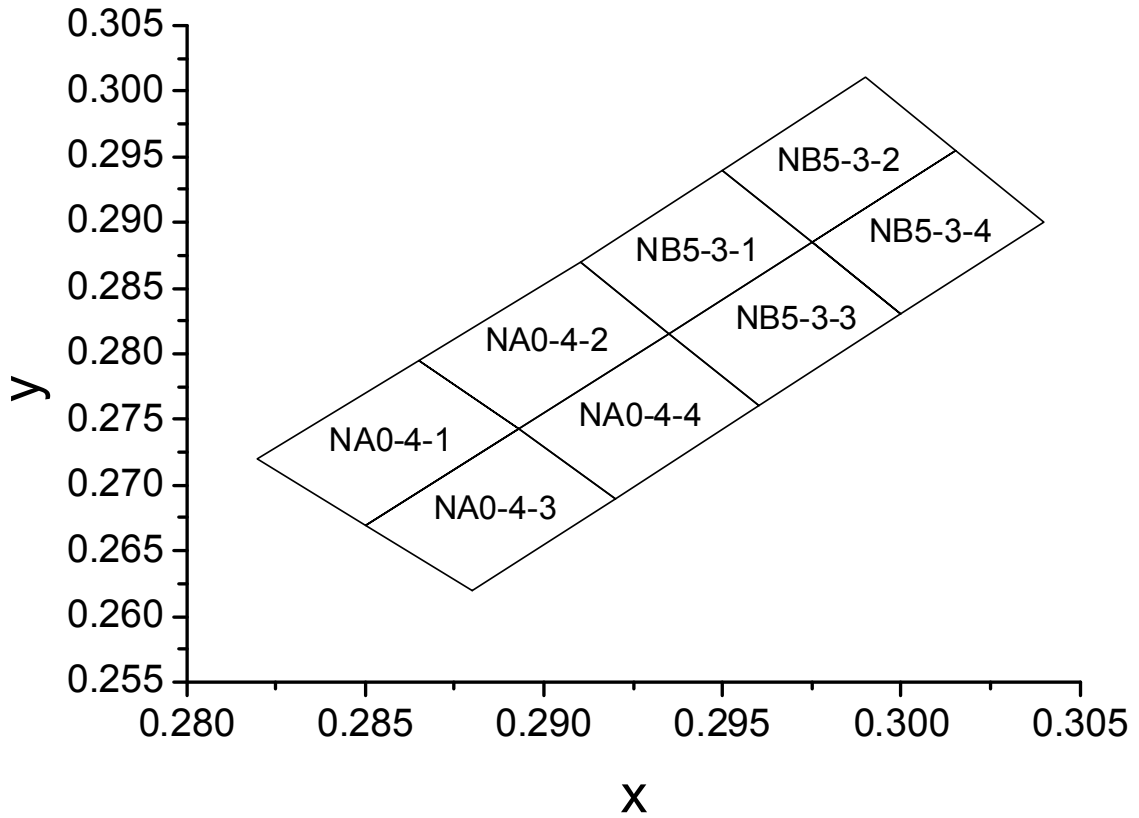

### Package Outline Dimensions

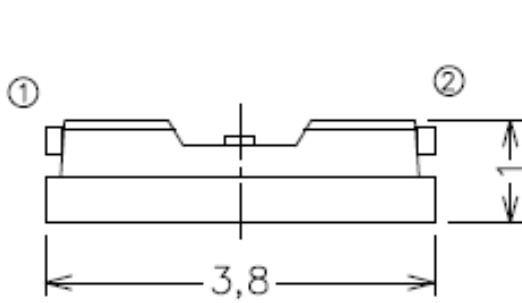

Polarity

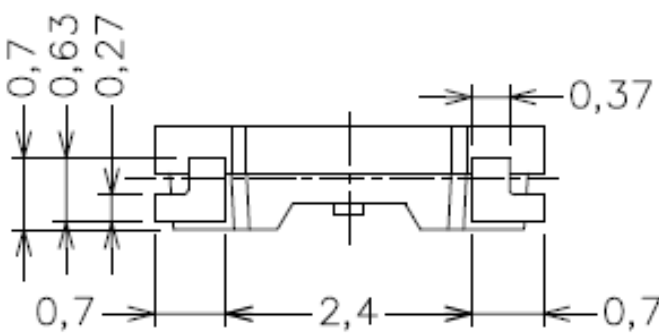
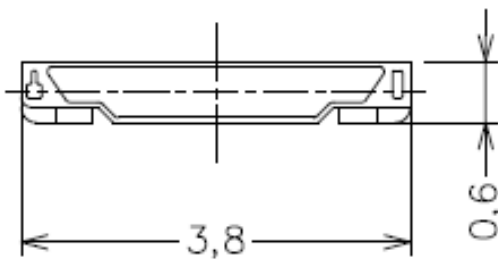

Bot. view

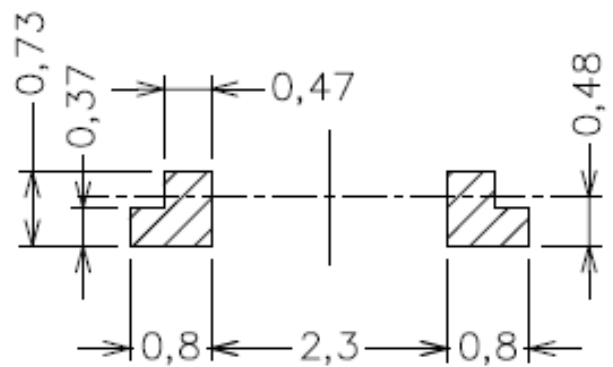

Soldering patterns

**Notes:** The tolerances unless mentioned is  $\pm 0.1$ mm, Unit = mm.

## Typical Electro-Optical-Thermal Characteristics Curves

1. Spectrum Distribution  
 ( $T_A=25^\circ\text{C}$ ,  $I_F=20\text{mA}$ )

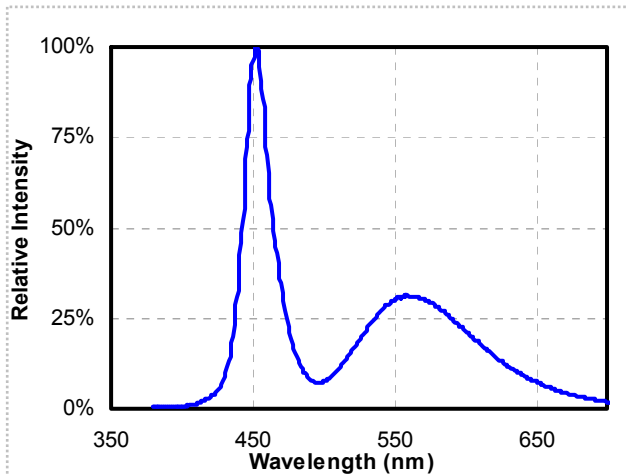

2. Relative Luminous Flux vs. Forward Current  
 ( $T_A=25^\circ\text{C}$ )

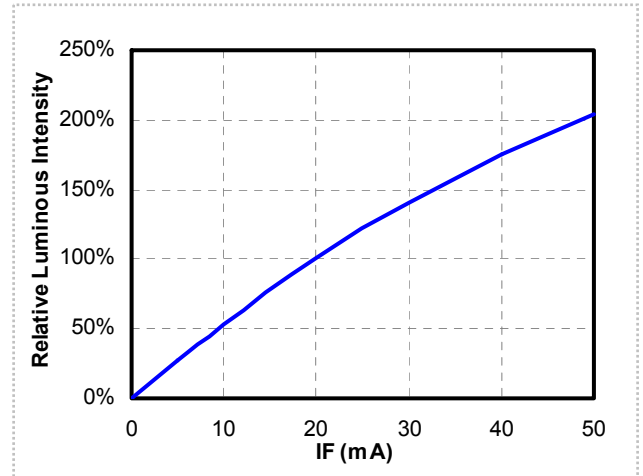

3. Relative Forward Voltage vs. Forward Current  
 ( $T_A=25^\circ\text{C}$ )

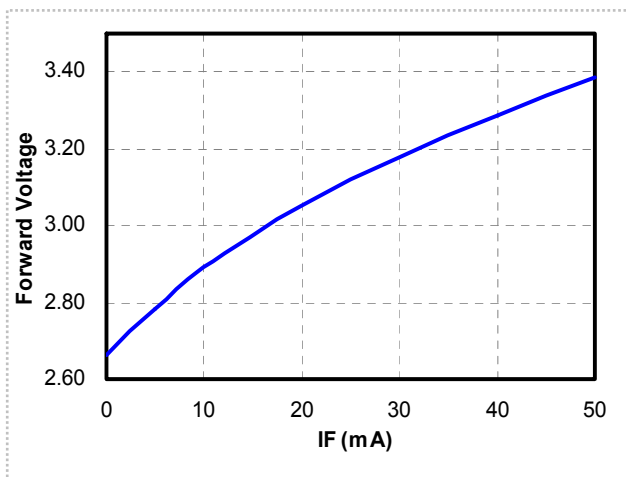

4. Radiation Diagram  
 ( $T_A=25^\circ\text{C}$ ,  $I_F=20\text{mA}$ )

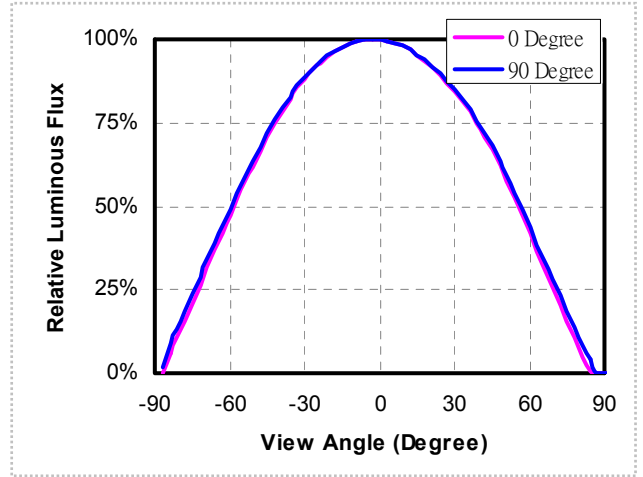

## Typical Electro-Optical-Thermal Characteristics Curves

5. Relative Luminous Flux vs. Solder Temperature  
( $I_F=20\text{mA}$ )

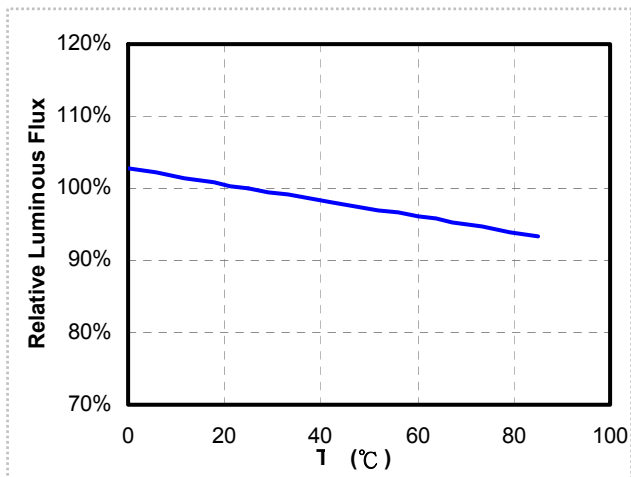

6. Forward Voltage vs. Solder Temperature  
( $I_F=20\text{mA}$ )

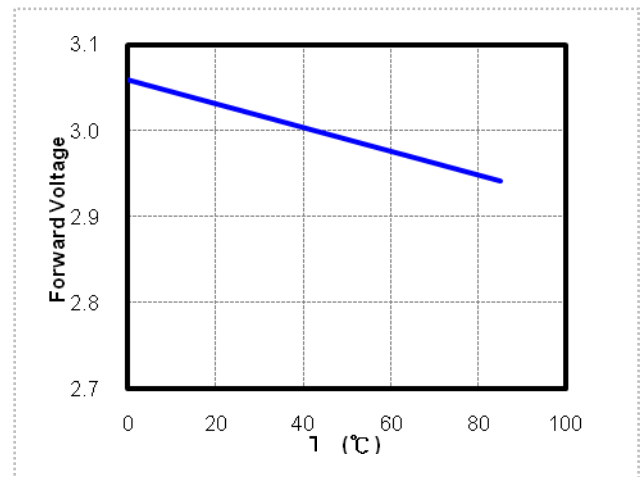

7. Chromaticity Coordinates vs. Solder Temperature  
( $I_F=20\text{mA}$ )

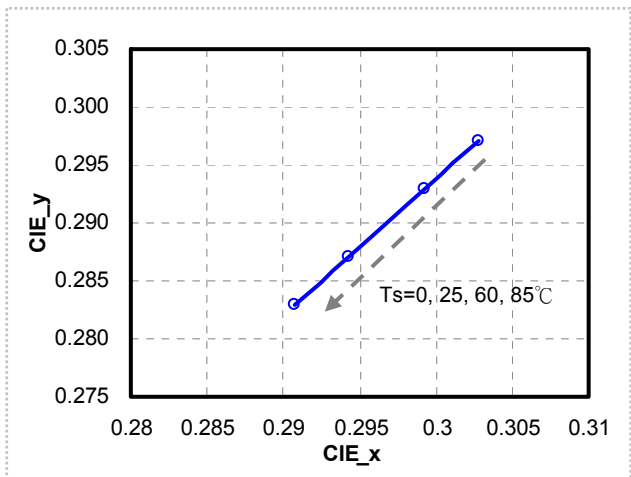

8. Forward Current De-rating Curve

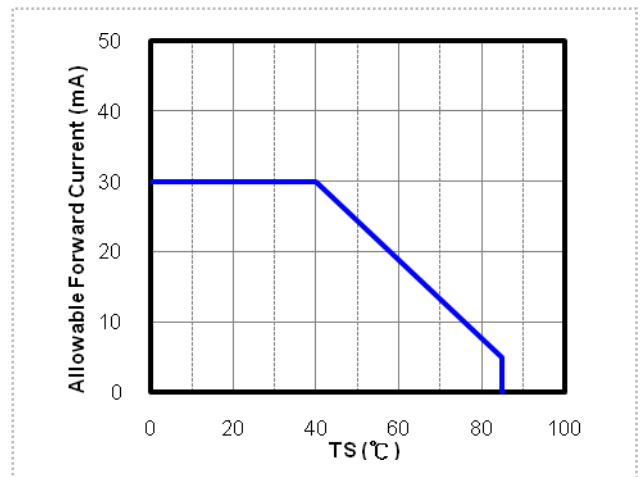



## Label Explanation

- CAT: Luminous Flux Rank
- HUE: Chromaticity Coordinates
- REF: Forward Voltage Rank



## Reel Dimensions

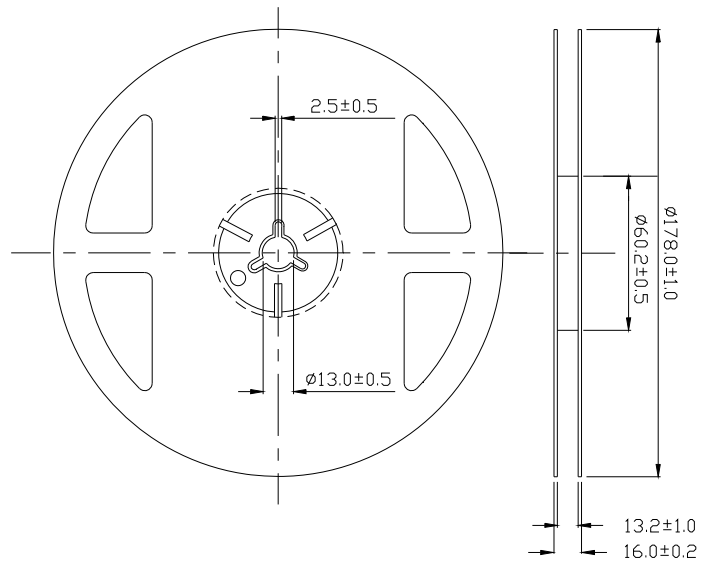

**Note:**

The tolerances unless mentioned is  $\pm 0.1$ mm, Unit = mm.

### Carrier Tape Dimensions: Loaded Quantity 2000 pcs. Per Reel

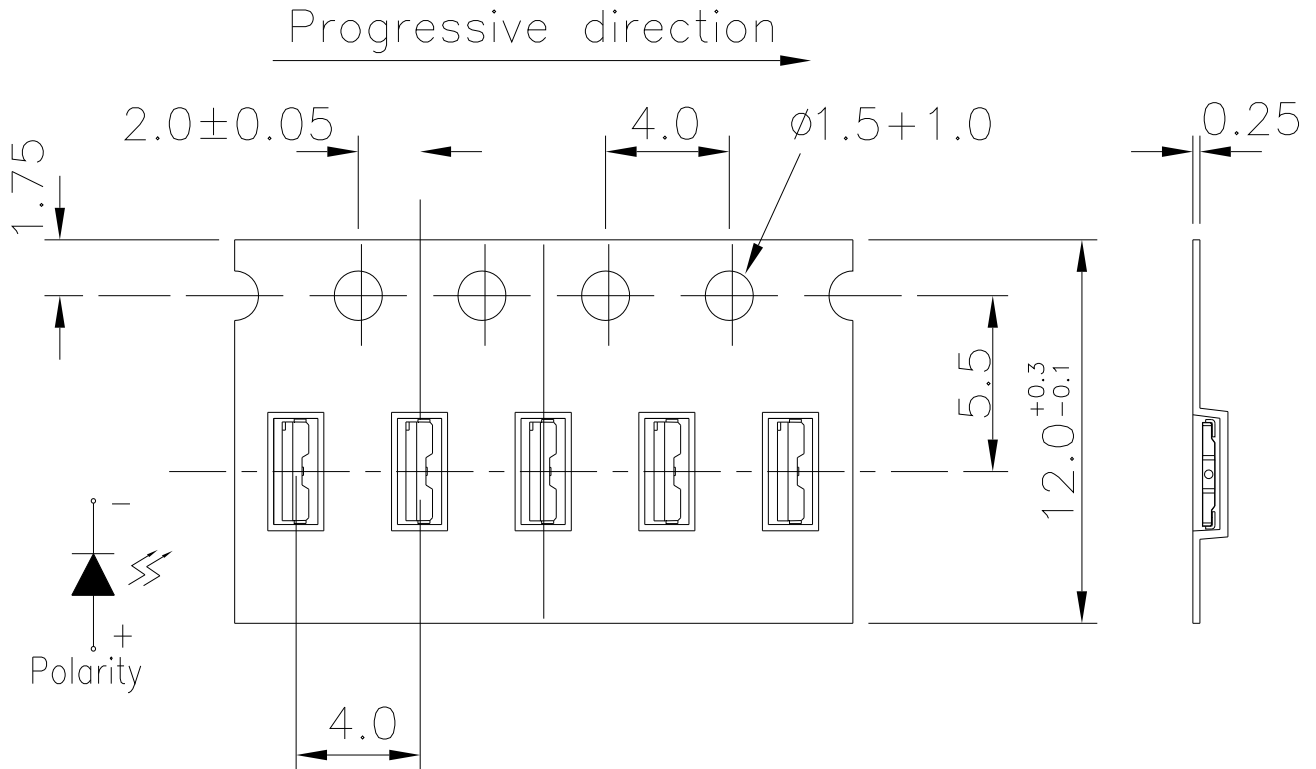

**Note:** The tolerances unless mentioned is  $\pm 0.1$  mm, Unit = mm.

### Moisture Resistant Packaging

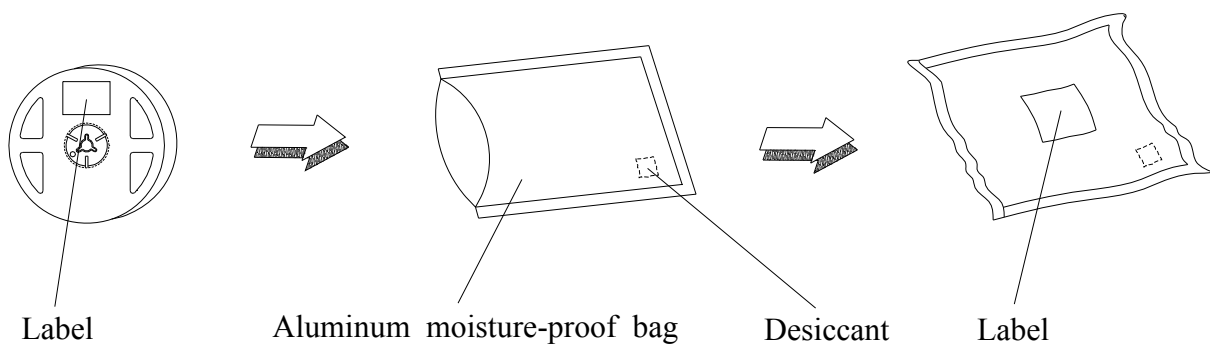

## Reliability Test Items and Conditions

The reliability of products shall be satisfied with items listed below.

Confidence level : 90%

LTPD : 10%

NO	Item	Test Condition		Test Hours / Times	Criteria	
		Temp./ Humidity	I <sub>F</sub> (mA)		I <sub>v</sub> @ 20mA	V <sub>F</sub> @ 20mA
1	Reflow Soldering	T = 260°C, Max. 10sec.		2 times	<±5%	<±5%
2	Temperature Cycle	-40°C 30min.	~ (5min.)	100°C 30min.	200 cycles	I <sub>v</sub> > 70%, V <sub>F</sub> < 110%,
3	Thermal Shock	-10°C 20min.	~ (<15sec.)	100°C 20min.	200 cycles	
4	Low Temp. Storage	Ta= -40°C	--	1000 hrs		
5	High Temp. Storage	Ta= 100°C	--	1000 hrs		
6	Temp. Humidity Storage	Ta= 60°C/ 90%RH	--	1000 hrs		
7	Steady State Operating Life of Low Temp.	Ta= -40°C	20	1000 hrs		
8	Steady State Operating Life Condition 1	Ta= 25°C/ Room Humidity	20	1000 hrs		
9	Steady State Operating Life Condition 2	Ta= 60°C	20	1000 hrs		
10	Steady State Operating Life of High Temp.	Ta= 85°C	5	1000 hrs		
11	Steady State Operating Life of High Humidity Heat	Ta= 60°C/ 90%RH	20	1000 hrs		

Notes:

1. Sampling for each test item: 22 (pcs.)
2. Test board: MCPCB board thickness=1.0mm, copper layer thickness=0.07mm, Rth<sub>ja</sub>= 380°C/W.
3. Measurements are performed after allowing the LEDs to return to room temperature.



## Precautions for Use

### 1. Over-current-proof

Customer must apply resistors for protection, otherwise slight voltage shift will cause big current change ( Burn out will happen ).

### 2. Storage

2.1 Do not open moisture proof bag before the products are ready to use.

2.2 Before opening the package: The LEDs should be used within one year and kept at 30°C or less and 70%RH or less.

2.3 After opening the package: We recommend that the LED should be soldered quickly (within 3 days). The soldering condition is 30°C or less and 60%RH or less. If unused LEDs remain, it should be stored in moisture proof packages.

2.4 If the moisture absorbent material (silica gel) has faded away or the LEDs have exceeded the storage time, baking treatment should be performed using the following conditions. Baking treatment: 60±5°C for 24 hours. (One time only)

### 3. Soldering Condition

#### 3.1 Pb-free solder temperature profile

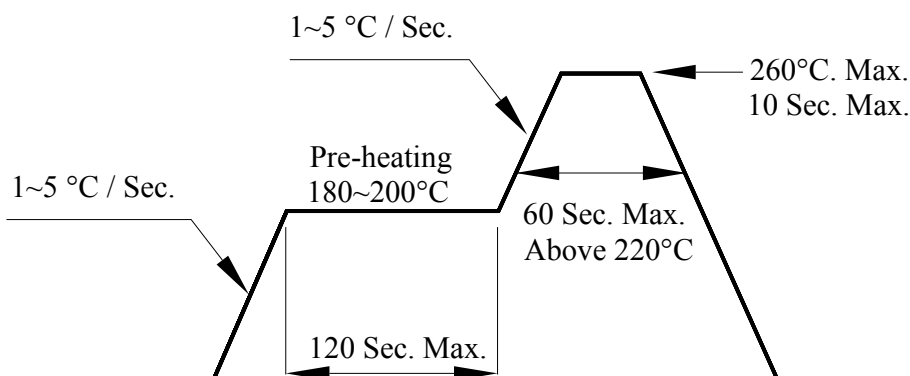

3.2 Reflow soldering should not be done more than two times.

3.3 When soldering, do not put stress on the LEDs during heating.

3.4 After soldering, do not warp the circuit board.

#### 4. Soldering Iron

Each terminal is to go to the tip of soldering iron temperature less than 350°C for 3 seconds within once in less than the soldering iron capacity 25W. Leave two seconds and more intervals, and do soldering of each terminal. Be careful because the damage of the product is often started at the time of the hand solder.

## 5. Repairing

Repair should not be done after the LEDs have been soldered. When repairing is unavoidable, a double-head soldering iron should be used (as below figure). It should be confirmed beforehand whether the characteristics of the LEDs will or will not be damaged by repairing.

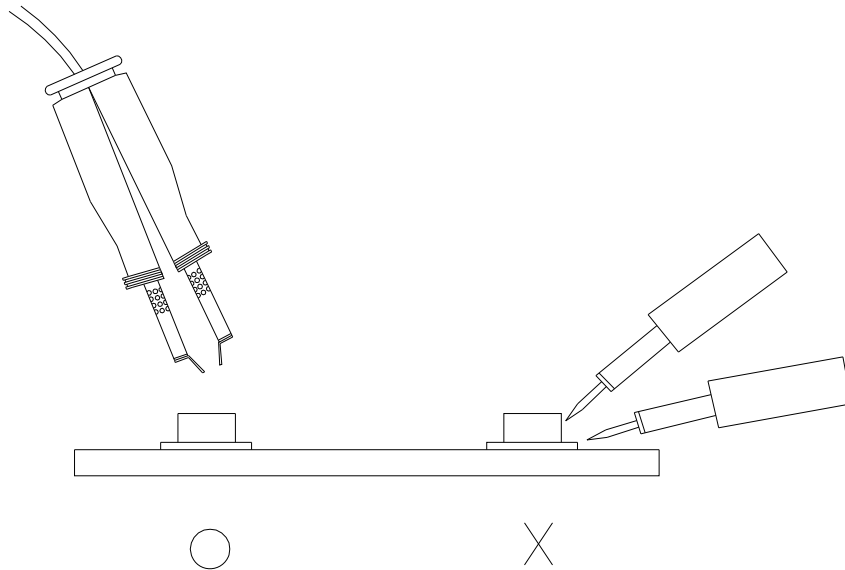

## 6. Handling Indications

During processing, mechanical stress on the surface should be minimized as much as possible. Sharp objects of all types should not be used to pierce the sealing compound.