

# EAHP3535WF6

## Introduction

The EAHP3535 series is a surface-mount high-power device featuring high brightness combined with a compact size that is suitable for all kinds of lighting applications such as general illumination, flash, spot, signal, industrial and commercial lighting. The EAHP3535 series is one of the most promising devices in Everlight's high power product offering and is ready to face the challenges of today's Solid-State Lighting requirements.



## Features

- ◆ Small package with high efficiency
- ◆ ESD protection up to 8KV
- ◆ Soldering method: SMT
- ◆ Binning Parameters: Brightness, Forward Voltage, Wavelength and Chromaticity
- ◆ Moisture Sensitivity Level: 1
- ◆ RoHS compliant
- ◆ Matches ANSI binning

## Applications

- ◆ General Lighting
- ◆ Decorative and Entertainment Lighting
- ◆ Signal and Symbol Luminaries for orientation marker lights (e.g. steps, exit ways, etc.)
- ◆ Agriculture Lighting

## Table of Contents

JEDEC Moisture Sensitivity.....	3
PN of the EAHP3535 Series: White LEDs.....	4
Product Binning.....	5
White Bin Structure .....	6
Pad Configuration .....	12
Reflow Soldering Characteristics .....	13
Wavelength Characteristics.....	14
V.S. Thermal Pad Temperature .....	15
Typical Electrical Characteristics.....	15
Current Derating Curves .....	17
Typical Radiation Patterns.....	18
Emitter Tape Packaging .....	19
Emitter Reel Packaging.....	20
Product Labeling .....	20
Reliability Data .....	21
Storage Conditions.....	22
Thermal Management .....	22
Revision History .....	23

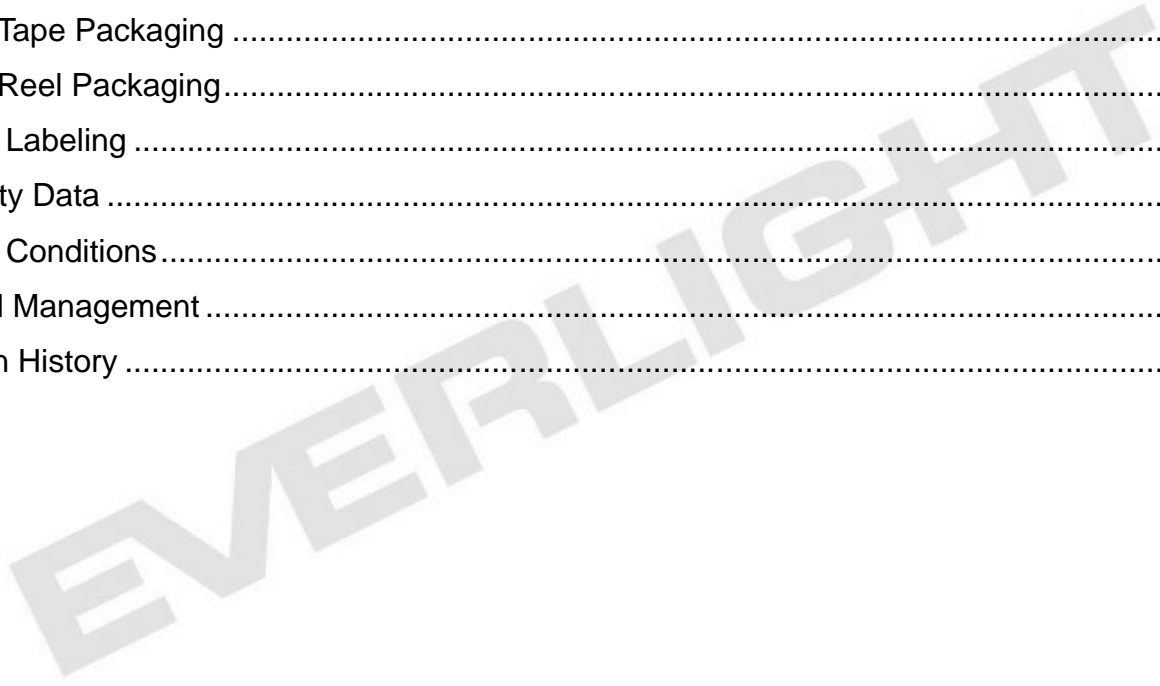

## Absolute Maximum Ratings

Parameter	Symbol	Ratings	Unit
Max. DC Forward Current (mA)	$I_F$	1000	mA
Max. Peak Pulse Current (mA)	$I_{Pulse}$	1250	mA
Max. ESD Resistance	$V_B$	8000	V
Reverse Voltage	$V_R$	Note 3	V
Thermal Resistance	$R_{th}$	5	°C/W
Max. Junction Temperature	$T_J$	150	°C
Operating Temperature	$T_{Opr}$	-40 ~ +100	°C
Storage Temperature	$T_{Stg}$	-40 ~ +100	°C
Max. Soldering Temperature	$T_{Sol}$	260	°C
Max. Allowable Reflow Cycles	n/a	2	cycles

**Notes:**

- EAHP3535 series Maximum forward current is 1000mA (Thermal Pad=25°C)
- EAHP3535 series Maximum peak pulse current is 1250mA (Duty cycle = 1/10@1KHZ)
- The EAHP3535 series LEDs are not designed for reverse bias use.

## JEDEC Moisture Sensitivity

Level	Floor Life		Soak Requirements Standard	
	Time (hours)	Conditions	Time (hours)	Conditions
1	Unlimited	$\leq 30^\circ\text{C} / 85\% \text{ RH}$	168 (+5/-0)	$85^\circ\text{C} / 85\% \text{ RH}$

**PN of the EAHP3535 Series: White LEDs**

Color	Order Code of EAHP3535	Minimum Luminous Flux (lm) @ Thermal Pad Temperature 85°C			Typ. Luminous Flux (lm) @ Thermal Pad Temperature 85°C			CCT (K) Wavelength (nm)	Forward Voltage (V)	CRI (Min.)
		350 mA	700 mA	1000 mA	350 mA	700 mA	1000 mA			
		Cool White 5700K	EAHP3535WF6	117 (130)	211 (235)	283 (315)	130 (145)			

**Notes:**

- 1.(value in bracket):Lminous flux @ 25°C, for reference only
- 2.CRI measurement tolerance: ±2.
- 3.Each 1W white PN is based on the min. bin, and includes two adjacent bins.

EVERLIGHT

## Product Binning Luminous Flux Bins

Group	Bin	Minimum Photometric Flux (lm)	Maximum Photometric Flux (lm)
E	1	4	5
	2	5	6
	3	6	8
	4	8	10
	5	10	13
	6	13	17
	7	17	20
	8	20	23
	9	23	27
F	1	27	33
	2	33	39
	3	39	45
	4	45	52
	5	52	60
	6	60	70
	7	70	80
	8	80	90
	9	90	100
	A	65	75
	B	75	85
	C	85	95
	E	95	105

Group	Bin	Minimum Photometric Flux (lm)	Maximum Photometric Flux (lm)
J	1	100	110
	2	110	120
	3	120	130
	4	130	140
	5	140	150
	6	150	160
	7	160	180
	8	180	200
	9	200	225
	A	105	115
	B	115	125
	C	125	135
	E	135	145
	F	145	155
K	G	155	170
	H	170	190
	J	190	210
	1	225	250
	2	250	275
	3	275	300
	4	300	325
	5	325	350
	6	350	375
	7	375	400
N	8	400	425
	9	425	450
	1	450	475
	2	475	500
	3	500	525
4	525	550	

### White Bin Structure

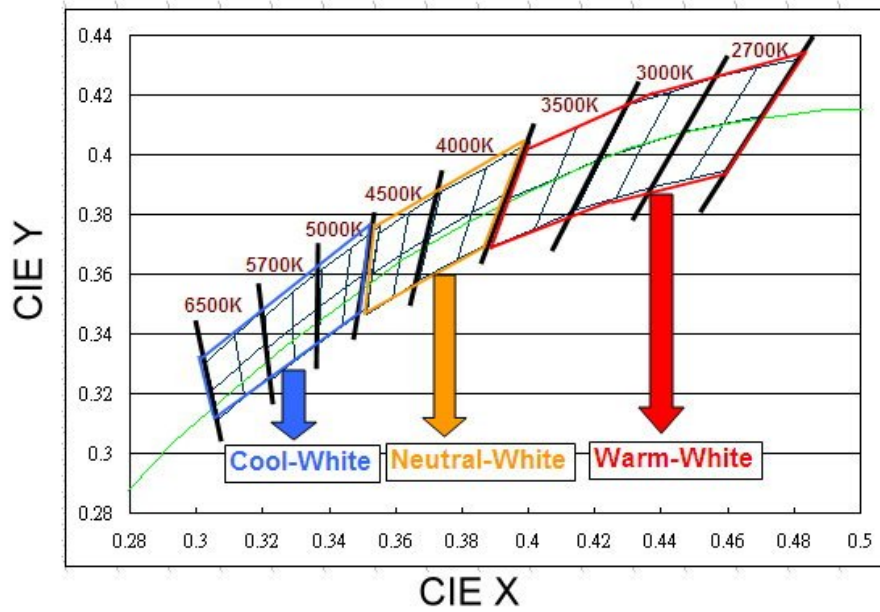

Chromaticity specification defined by ANSI

**Notes:**

1. The CCT range of Cool-White varies from 4745K to 7050K.
2. The CCT range of Neutral-White varies from 3710K to 4745K.
3. The CCT range of Warm-White varies from 2580K to 3710K
4. Color coordinates measurement allowance : ±0.01
5. Color bins are defined at  $I_f=350\text{mA}$  operation.

### Cool-White Bin Structure

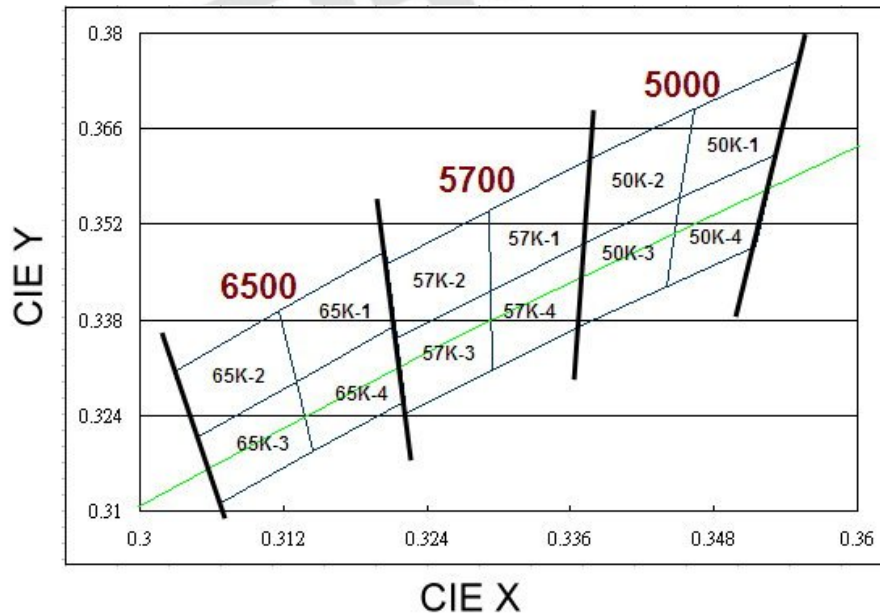

**Cool-White Bin Coordinates**

**5000K**

Bin	CIE X	CIE Y
50K-1	0.346	0.369
	0.345	0.356
	0.353	0.362
	0.355	0.376
Reference Range: 4745~5000K		

Bin	CIE X	CIE Y
50K-2	0.338	0.362
	0.337	0.349
	0.345	0.356
	0.346	0.369
Reference Range: 5000~5310K		

Bin	CIE X	CIE Y
50K-4	0.345	0.356
	0.344	0.343
	0.352	0.349
	0.353	0.362
Reference Range: 4745~5000K		

Bin	CIE X	CIE Y
50K-3	0.337	0.349
	0.337	0.337
	0.344	0.343
	0.345	0.356
Reference Range: 5000~5310K		

**5700K**

Bin	CIE X	CIE Y
57K-1	0.329	0.354
	0.329	0.342
	0.337	0.349
	0.338	0.362
Reference Range: 5310~5700K		

Bin	CIE X	CIE Y
57K-2	0.321	0.346
	0.321	0.335
	0.329	0.342
	0.329	0.354
Reference Range: 5700~6020K		

Bin	CIE X	CIE Y
57K-4	0.329	0.342
	0.329	0.331
	0.337	0.337
	0.337	0.349
Reference Range: 5310~5700K		

Bin	CIE X	CIE Y
57K-3	0.321	0.335
	0.322	0.324
	0.329	0.331
	0.329	0.342
Reference Range: 5700~6020K		

**6500K**

Bin	CIE X	CIE Y
65K-1	0.312	0.339
	0.313	0.329
	0.321	0.337
	0.321	0.348
Reference Range: 6020~6500K		

Bin	CIE X	CIE Y
65K-2	0.303	0.330
	0.305	0.321
	0.313	0.329
	0.312	0.339
Reference Range: 6500~7050K		

Bin	CIE X	CIE Y
65K-4	0.313	0.329
	0.315	0.319
	0.322	0.326
	0.321	0.337
Reference Range: 6020~6500K		

Bin	CIE X	CIE Y
65K-3	0.305	0.321
	0.307	0.311
	0.315	0.319
	0.313	0.329
Reference Range: 6500~7050K		

### Neutral-White Bin Structure

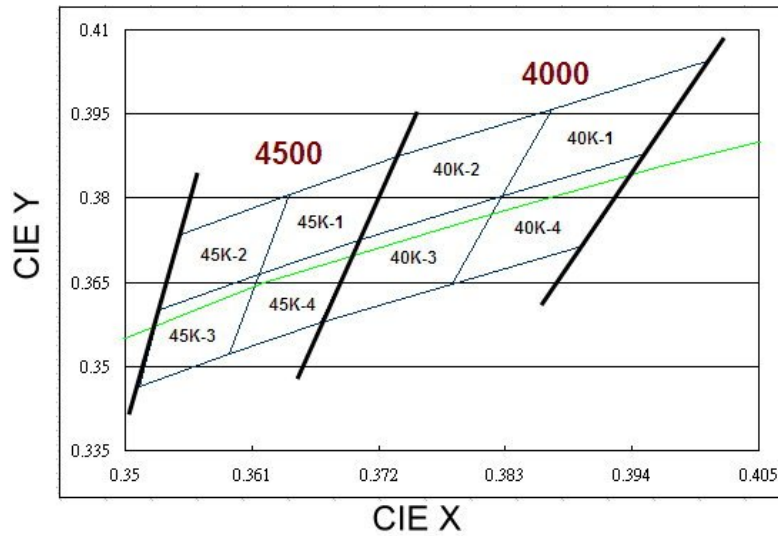

### Neutral-White Bin Coordinates

**4000K**

Bin	CIE X	CIE Y
40K-1	0.387	0.396
	0.383	0.380
	0.395	0.388
	0.401	0.404
Reference Range: 3710~4000K		

Bin	CIE X	CIE Y
40K-2	0.374	0.387
	0.370	0.373
	0.383	0.380
	0.387	0.396
Reference Range: 4000~4260K		

Bin	CIE X	CIE Y
40K-4	0.383	0.380
	0.378	0.365
	0.390	0.372
	0.395	0.388
Reference Range: 3710~4000K		

Bin	CIE X	CIE Y
40K-3	0.370	0.373
	0.367	0.358
	0.378	0.365
	0.383	0.380
Reference Range: 4000~4260K		



### Warm-White Bin Structure

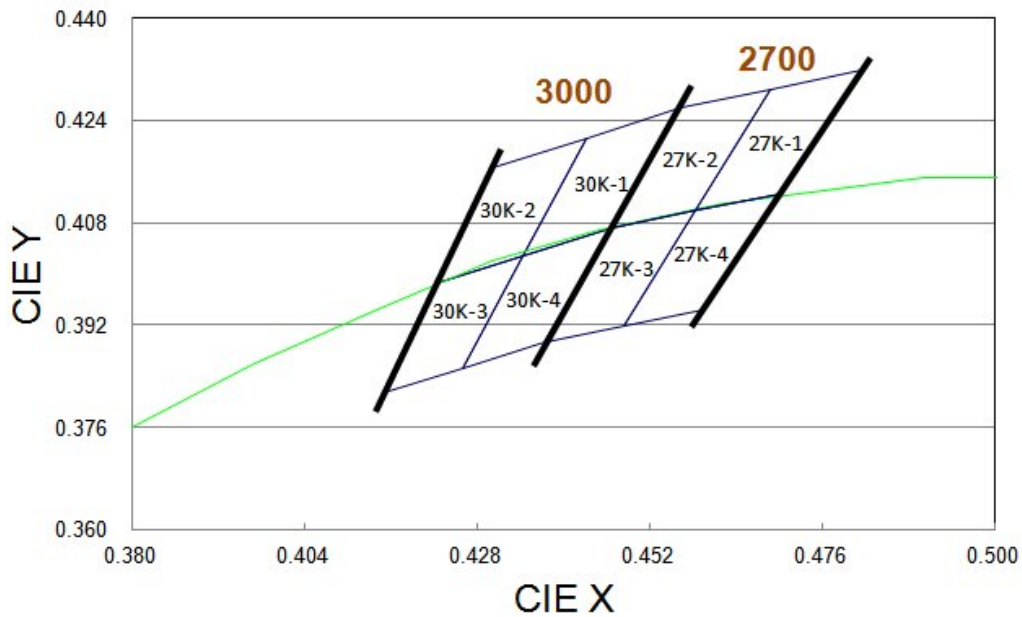

### Warm-White Bin Coordinates

#### 2700K

Bin	CIE X	CIE Y
27K-1	0.4582	0.4099
	0.4687	0.4289
	0.4813	0.4319
	0.4700	0.4126
Reference Range: 2580~2700K		

Bin	CIE X	CIE Y
27K-2	0.4465	0.4071
	0.4562	0.4260
	0.4687	0.4289
	0.4582	0.4099
Reference Range: 2700~2870K		

Bin	CIE X	CIE Y
27K-4	0.4483	0.3919
	0.4582	0.4099
	0.4700	0.4126
	0.4593	0.3944
Reference Range: 2580~2700K		

Bin	CIE X	CIE Y
27K-3	0.4373	0.3893
	0.4465	0.4071
	0.4582	0.4099
	0.4483	0.3919
Reference Range: 2700~2870K		

#### 3000K

Bin	CIE X	CIE Y
30K-1	0.4342	0.4028
	0.4430	0.4212
	0.4562	0.4260
	0.4465	0.4071
Reference Range: 2870~3000K		

Bin	CIE X	CIE Y
30K-2	0.4221	0.3984
	0.4299	0.4165
	0.4430	0.4212
	0.4342	0.4028
Reference Range: 3000~3220K		

Bin	CIE X	CIE Y
30K-4	0.4259	0.3853
	0.4342	0.4028
	0.4465	0.4071
	0.4373	0.3893
Reference Range: 2870~3000K		

Bin	CIE X	CIE Y
30K-3	0.4147	0.3814
	0.4221	0.3984
	0.4342	0.4028
	0.4259	0.3853
Reference Range: 3000~3220K		

### Forward Voltage Bins

Group Name	Bins
<b>C</b>	U4+V1+V2+V3

Bin	Minimum Forward Voltage (V)	Maximum Forward Voltage (V)
U1	1.75	2.05
U2	2.05	2.35
U3	2.35	2.65
U4	2.65	2.95
V1	2.95	3.25
V2	3.25	3.55
V3	3.55	3.85

**Notes:**

1. Forward voltage measurement tolerance:  $\pm 0.1V$ .
2. Forward voltage bins are defined at  $I_f=350mA$  operation.
3. Other Forward Voltage bins for White LEDs available upon request. Please contact your local Everlight sales office.

EVERLIGHT

## 1. Mechanical Dimension

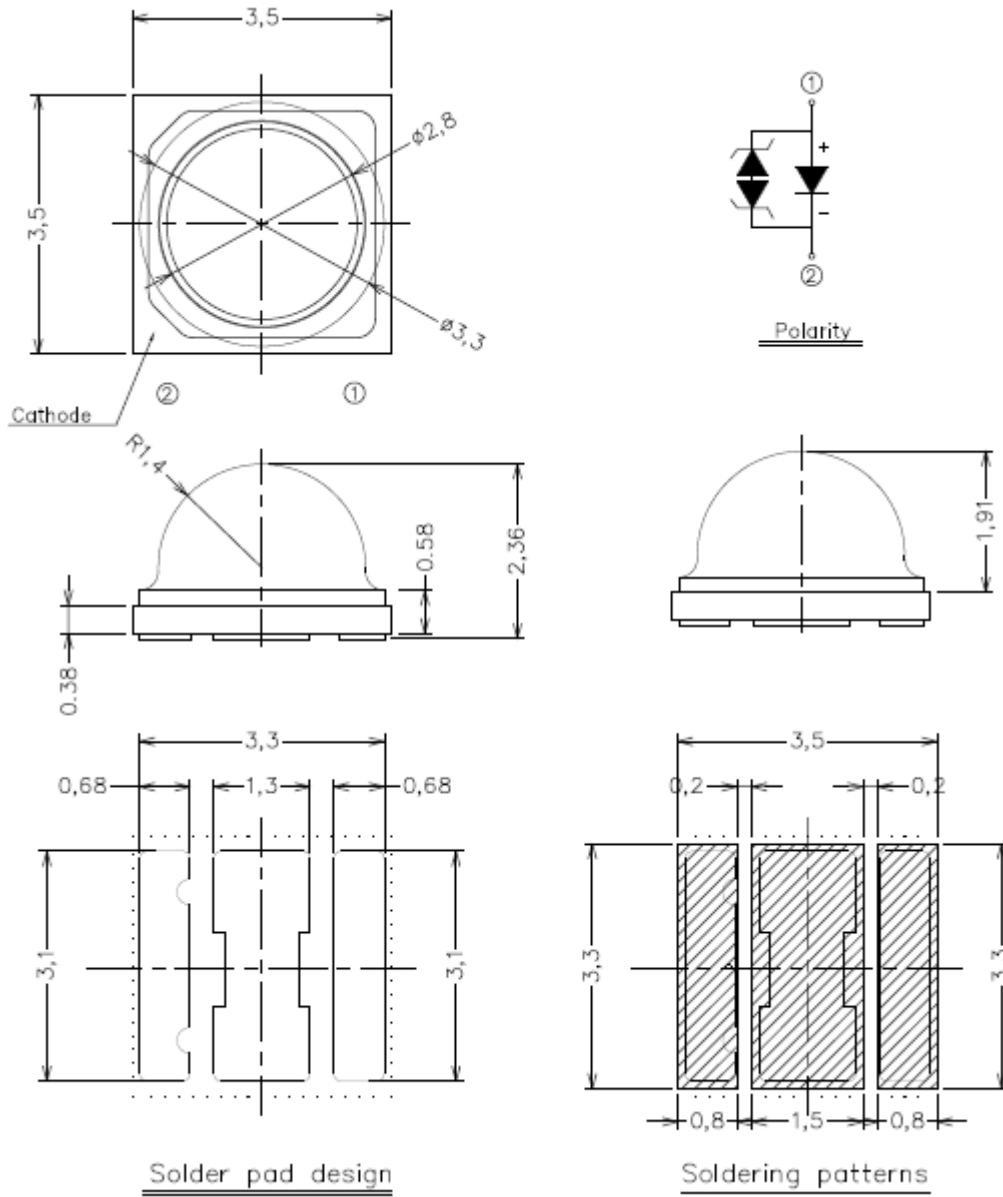

### Notes:

1. Dimensions are in millimeters.
2. Tolerances unless mentioned are  $\pm 0.15$ mm.
3. The thermal pad is electrically isolated from the Anode and Cathode contact pads.
4. Do not handle the device by the lens. Incorrect force applied to the lens may lead to the failure of devices.

## Pad Configuration

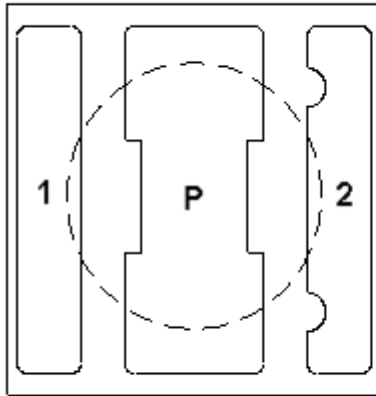

**BOTTOM VIEW**

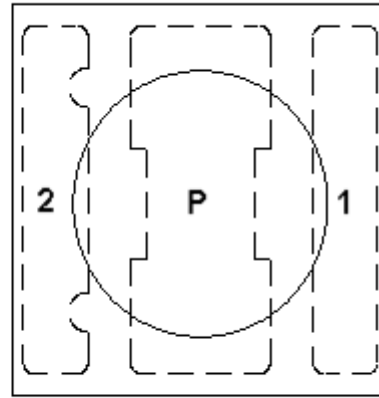

**TOP VIEW**

PAD	FUNCTION
1	ANODE
2	CATHODE
P	THERMAL PAD

## Reflow Soldering Characteristics

### For Reflow Process

- EAHP3535 series are suitable for SMT processes.
- Curing of glue in oven must be according to standard operation flow processes.

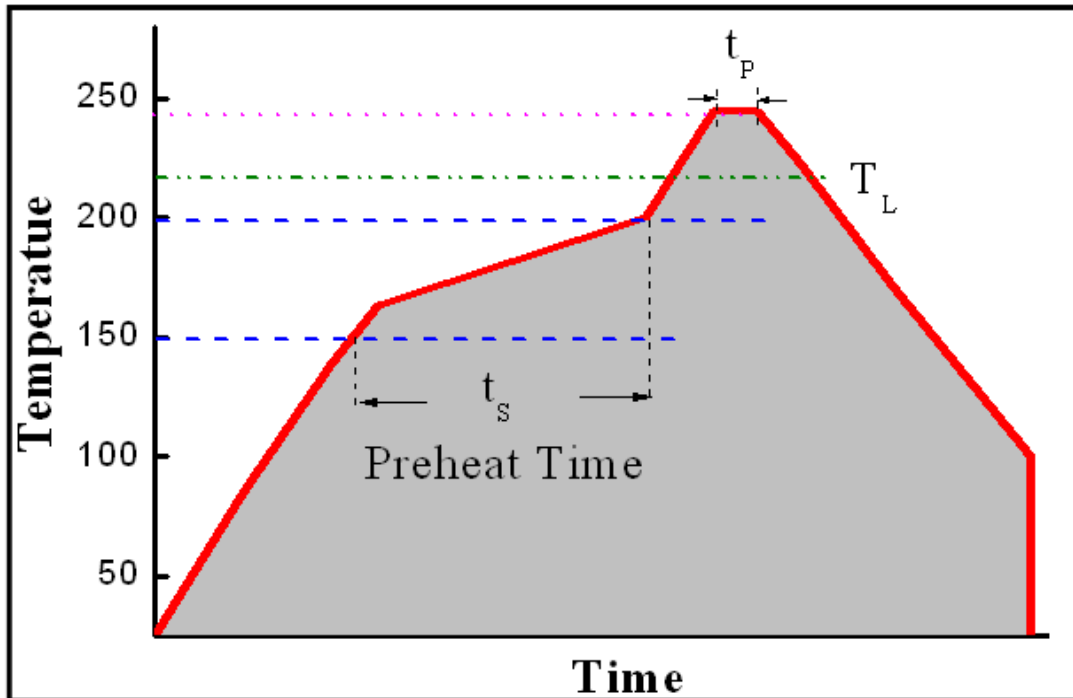

Profile Feature	Lead Free Assembly
Ramp-Up Rate	2-3 °C/S
Preheat Temperature	150-200 °C
Preheat Time ( $t_s$ )	60-120 S
Liquid Temperature ( $T_L$ )	217 °C
Time maintained above $T_L$	60-90 S
Peak Temperature ( $T_P$ )	240±5 °C
Peak Time ( $t_P$ )	Max 20 S
Ramp-Down Rate	3-5 °C/S

- Reflow soldering should not be done more than twice.
- In soldering process, stress on the LEDs during heating should be avoided.
- After soldering, do not bend the circuit board.

## Wavelength Characteristics

Cool-White @ Thermal Pad Temperature = 25°C

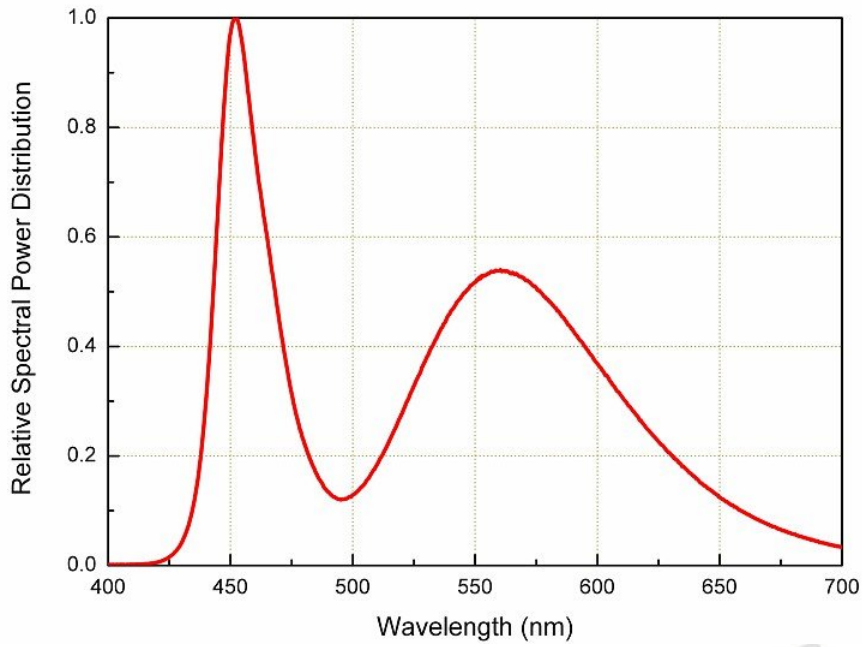

For Warm-White, @ Thermal Pad Temperature = 25°C

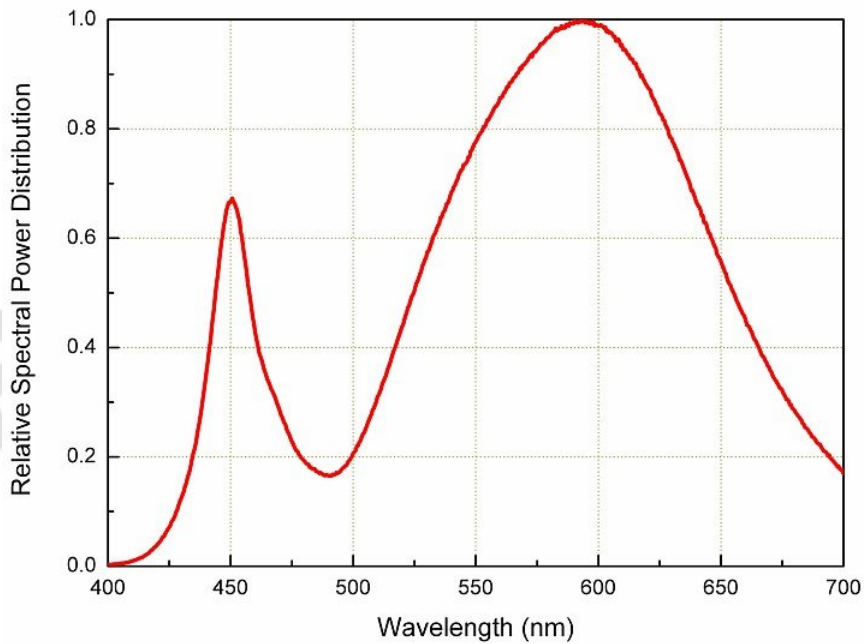

## Typical Light Output Characteristic V.S. Thermal Pad Temperature

Cool-White, Warm-White for 350mA Drive Current

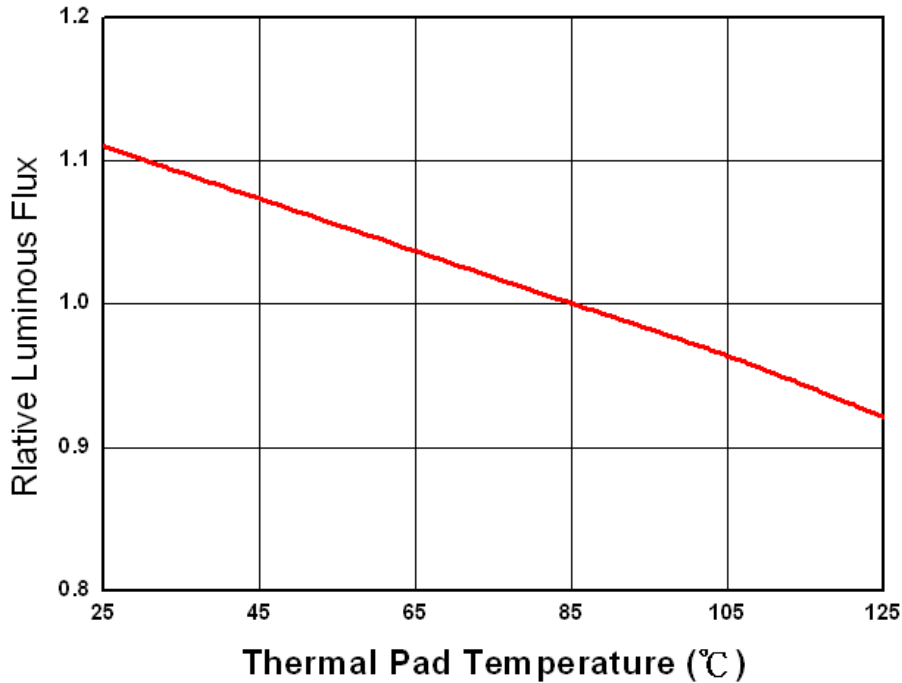

## Typical Electrical Characteristics

Cool-White, Warm-White @ Thermal Pad Temperature = 25°C

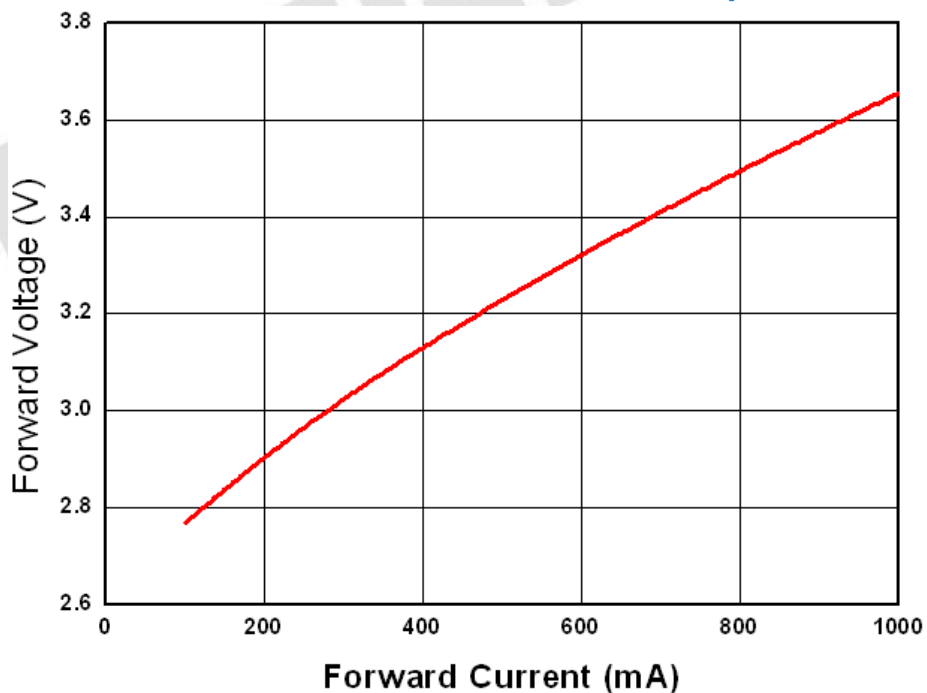

## Typical Relative Luminous Flux V.S. Forward Current

Cool-White, Warm-White Thermal Pad Temperature = 25°C

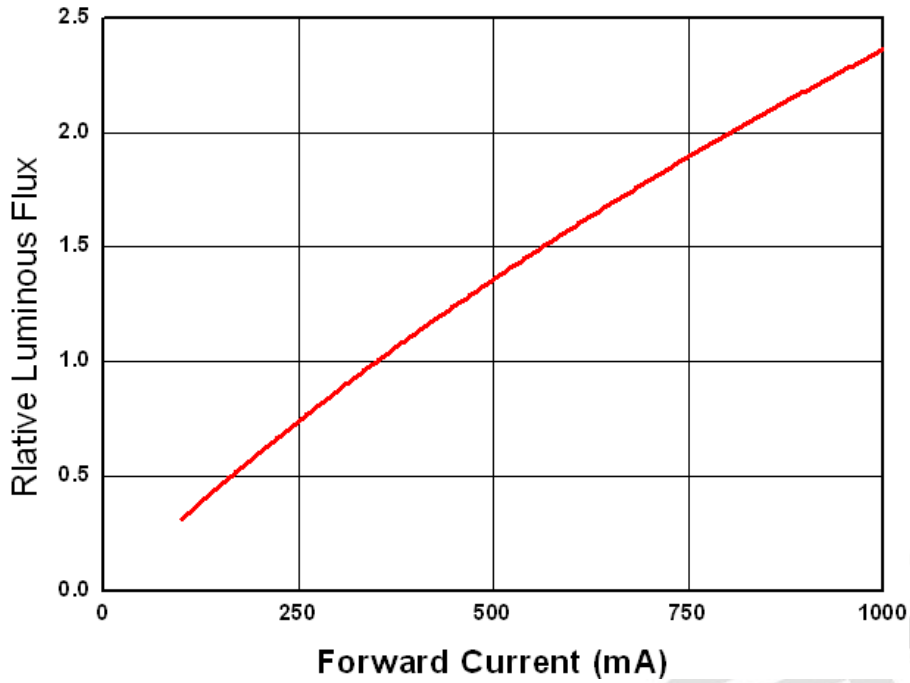

EVERLIGHT



## Current Derating Curves (For EAHP3535 series)

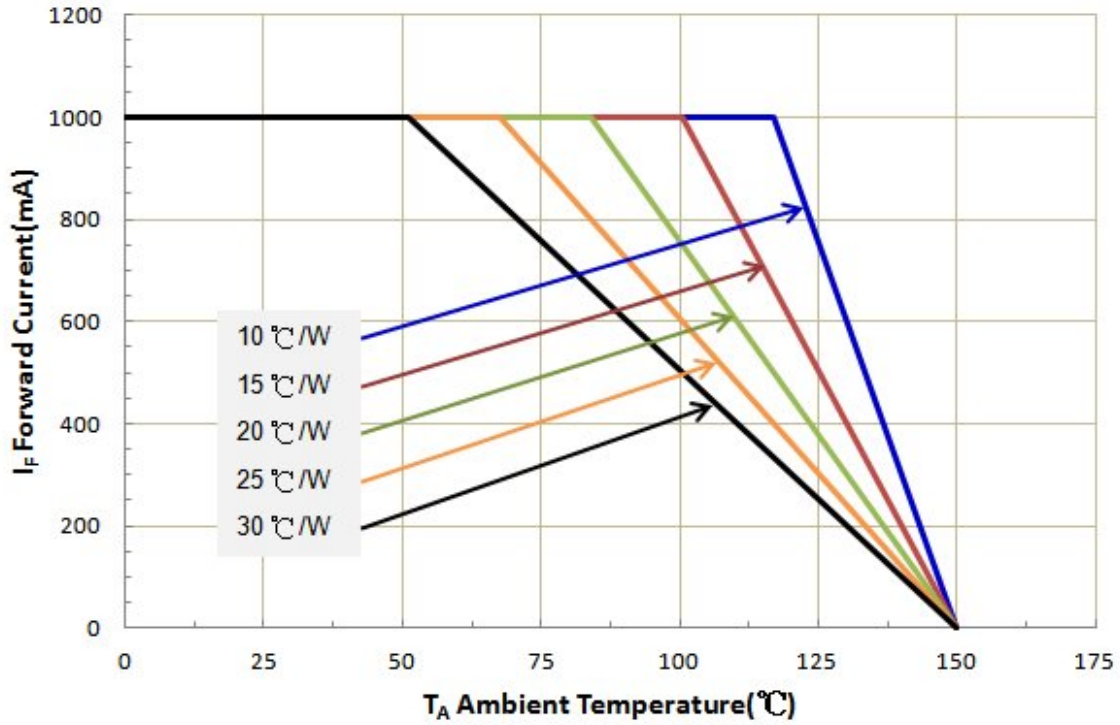

**Note:**

The current derating curves are depending on the thermal resistance between the junction to the Ambient Temperature.

## Typical Radiation Patterns

### EAHP3535 series: Typical Diagram Characteristics of Radiation

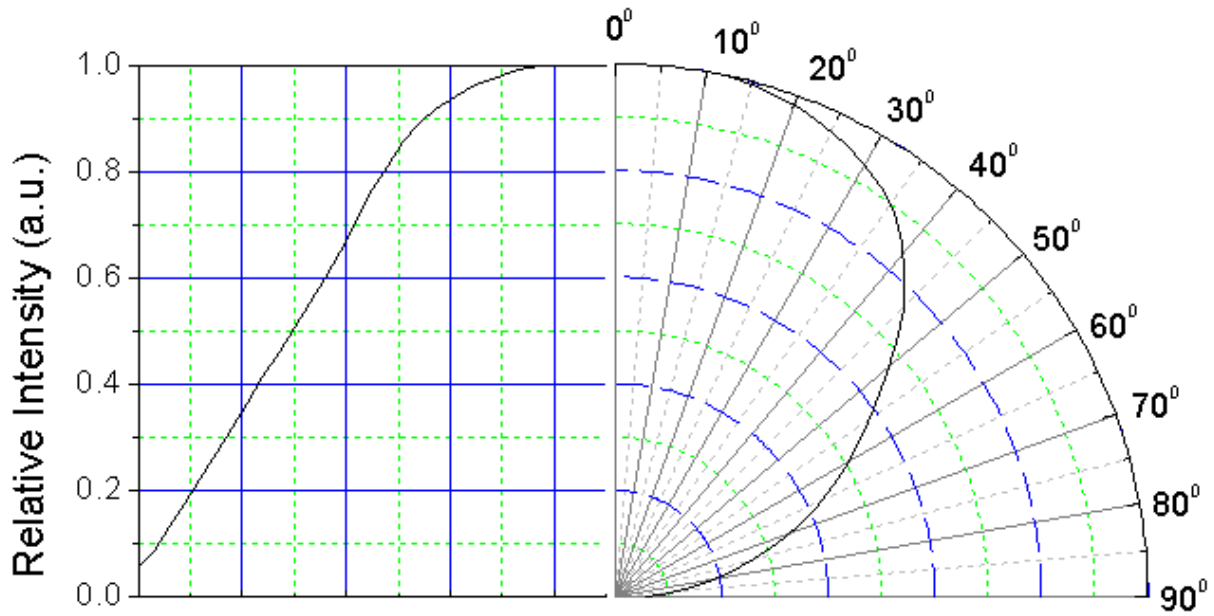

**Notes:**

1.  $2\theta_{1/2}$  is the off axis angle from lamp centerline where the luminous intensity is 1/2 of the peak value.
2. View angle tolerance is  $\pm 5^\circ$ .

## Emitter Tape Packaging

Carrier Tape Dimensions as the following:

Reel: 400pcs, MOQ $\geq$  2Kpcs(has to be a multiple of 800pcs)

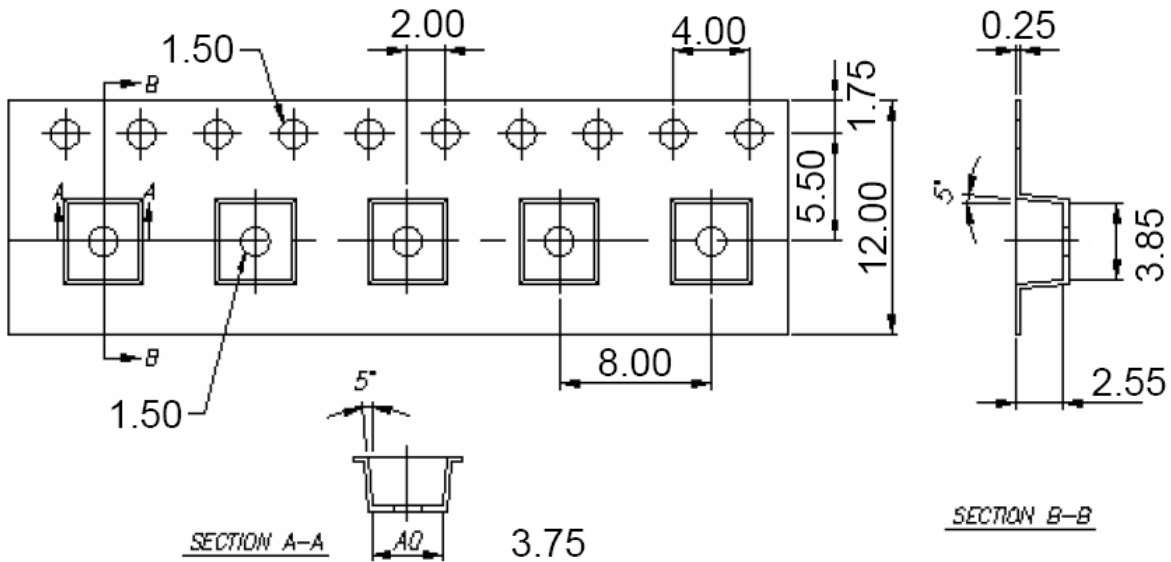

**Notes:**

1. Dimensions are in millimeters.
2. Tolerances for fixed dimensions are  $\pm 0.1\text{mm}$ .

## Moisture Resistant Packaging

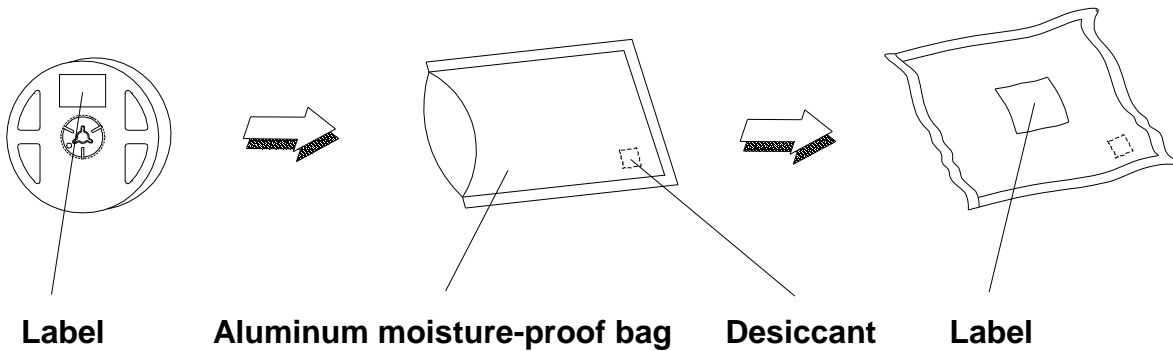

## Emitter Reel Packaging

### Reel Dimensions

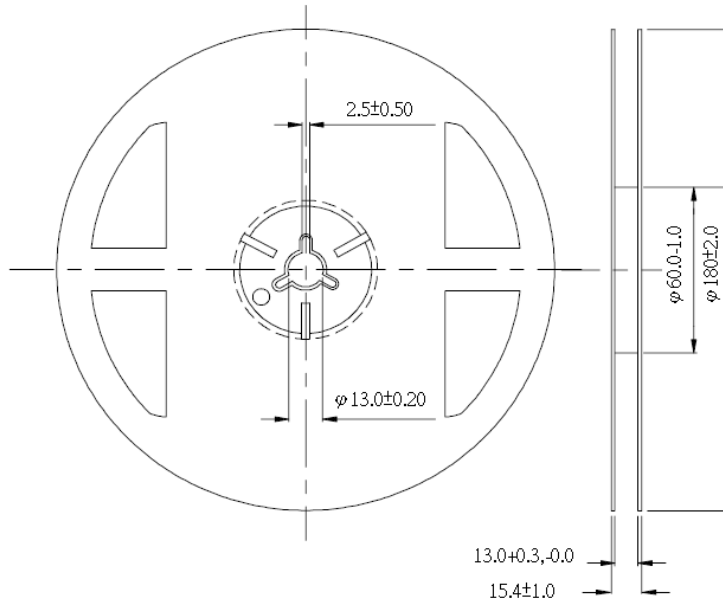

### Notes:

1. Dimensions are in millimeters.
2. Tolerances unless mentioned are  $\pm 0.1$ mm.

## Product Labeling

### Label Explanation

CPN: Customer Specification (when required)

P/N : Everlight Production Number

QTY: Packing Quantity

CAT: Luminous Flux (Brightness) Bin

HUE: Color Bin

REF: Forward Voltage Bin

LOT No: Lot Number

MADE IN TAIWAN: Production Place

RoHS	<b>(Pb)</b>	<b>EVERLIGHT</b>	<b>5</b>
CPN : XXXXXXXXXXXXXXXXXXXXXXXX			
XXXXXXXXXX-XXXXXXXXXX-XXXXXXXXXX-XXXXXXXXXX-XXXXXX			
P/N : XXXXXXXXXXXX			
XXXXXXXXXX-XXXXXXXXXX-XXXXXXXXXX-XXXXXXXXXX-XXXXXX			
LOT NO: Y150716XXX-XXXXXXXXXX-XXXXXXXXXX			
QTY: 0123456789 HUE: XXXXXXXXXXXX			
CAT: XXXXXXXXXXXX REF: XXXXXXXXXXXX			
REFERENCE: BTPYMMDDXXXXX			
MSL-X MADE IN XXXXXX			



## Reliability Data

Stress Test	Stress Condition	Stress Duration
Reflow	Tsol=260°C, 10sec	3 times
Thermal Shock	H : +100°C 20min. ↓ 10sec. L : -10°C 20min.	1000 Cycles
Temperature Cycle	H : +100°C 30min. ↓ 5min. L : -40°C 30min.	1000 Cycles
Room Temperature Operation Life	Ta=25°C, IF=350mA	1000hours
High Temperature Operation Life #1	Ta=55°C, IF=350mA	1000hours
High Temperature Operation Life #2	Ta=85°C, IF=225mA	1000hours
Low Temperature Operation Life	Ta=-40°C, IF=350mA	1000hours

### Failure Criteria:

1. LEDs are open or shorted
2. Im: luminous flux attenuate difference(1000hrs)>30%
3. VF: forward voltage difference(1000hrs)>20%
6. CCT: Color coordinates measurement allowance (1000hrs) >±0.02

## Storage Conditions

- Recommended to operate in accordance with the following conditions, increased LED life.
- Before the package is opened. The LEDs should be stored at 30°C or less and 85%RH or less after being shipped from Everlight and the storage life limits are 1 year. The LEDs can be stored up to 3 years If in a sealed container with a nitrogen atmosphere and moisture absorbent material.
- After opening the package: The LED's floor life is 1 year under 30°C or less and 60%RH or less. The LED should be soldered with 168hrs (7days) after opening the package. If unused LEDs remain, it should be stored in moisture proof packages.
- If the moisture absorbent material (silica gel) has faded away or the LEDs have exceeded the storage time, baking treatment should be performed using the following conditions. Baking treatment: 60±5°C for 24 hours.

## Thermal Management

- Recommended to operate in accordance with the following conditions, increased LED life.
- For maintaining the high flux output and achieving maximum reliability, EHP-C19 flashlight series LEDs should be mounted on a metal core printed circuit board (MCPCB) or other kinds of heat sink with proper thermal connection to dissipate approximately 1W of thermal energy at 350mA operation.
- Sufficient thermal management must be implemented. Please refer to the graph "Forward Current Derating Curve" on Page 20. The soldering temperature must be kept under 60°C at the driving current 350mA. Otherwise, the junction temperature of die may exceed over the limit at high current driving conditions and the LEDs' lifetime may be decrease dramatically.
- Special thermal designs are also recommended to take in outer heat sink design, such as FR4 PCB on Aluminum with thermal vias or FPC on Aluminum with thermal conductive adhesive, etc.
- Sufficient thermal management must be conducted, or the die junction temperature will be over the limit under large electronic driving and LED lifetime will decrease critically.

## Revision History

Current version: 2015/10/01  
Device No: DHE-0002920  
Version: 1.0

Page	Subjects (major change in previous version)	Date of change

EVERLIGHT