

### SMD ■ Side View LEDs (0.8mm) EAPL2812YA0

PRELIMINARY



#### Features

- Side view LED.
- Lead frame package with individual 2 pins.
- Wide viewing angle.
- Soldering methods: IR reflow soldering.
- ESD protection.
- Pb-free.
- The product itself will remain within RoHS compliant version.

#### Description

Due to the package design, this series has wide viewing angle , low power consumption and white LEDs are devices . This feature makes the LED ideal for light guide application.

#### Applications

- LCD Back Light.
- Mobile phones .
- Indicators.
- Illuminations.
- Switch Lights.

## Device Selection Guide

Chip Materials	Emitted Color	Resin Color
AlGaInP	Brilliant Yellow	Water Clear

## Absolute Maximum Ratings (Ta=25°C)

Parameter	Symbol	Rating	Unit
Reverse Voltage	$V_R$	5	V
Forward Current	$I_F$	50	mA
Peak Forward Current (Duty 1/10 @1KHz)	$I_{FP}$	100	mA
Power Dissipation	$P_d$	120	mW
Junction Temperature	$T_j$	115	°C
Operating Temperature	$T_{opr}$	-40 ~ +85	°C
Storage Temperature	$T_{stg}$	-40 ~ +90	°C
Thermal Resistance	$R_{th\ J-A}$	500	K/W
	$R_{th\ J-S}$	300	K/W
ESD (Classification acc. AEC Q101)	$ESD_{HBM}$	2000	V
	$ESD_{MM}$	200	V
Soldering Temperature	$T_{sol}$	Reflow Soldering : 260 °C for 10 sec. Hand Soldering : 350 °C for 3 sec.	

### Electro-Optical Characteristics (Ta=25°C)

Parameter	Symbol	Min.	Typ.	Max.	Unit	Condition
Luminous Intensity	I <sub>v</sub>	450	-----	900	mcd	I <sub>F</sub> =20mA
Viewing Angle	2θ <sub>1/2</sub>	-----	120	-----	deg	I <sub>F</sub> =20mA
Peak Wavelength	λ <sub>p</sub>	-----	591	-----	nm	I <sub>F</sub> =20mA
Dominant Wavelength	λ <sub>d</sub>	585.5	----	594.5	nm	I <sub>F</sub> =20mA
Spectrum Radiation Bandwidth	Δλ	-----	15	-----	nm	I <sub>F</sub> =20mA
Forward Voltage	V <sub>F</sub>	1.75	----	2.35	V	I <sub>F</sub> =20mA
Reverse Current	I <sub>R</sub>	-----	-----	50	μA	V <sub>R</sub> =5V

Note:

1. Tolerance of Luminous Intensity: ±11%
2. Tolerance of Dominant Wavelength: ±1nm
3. Tolerance of Forward Voltage: ±0.1V

### Bin Range of Luminous Intensity

Bin Code	Min.	Max.	Unit	Condition
U1	450	565	mcd	I <sub>F</sub> =20mA
U2	565	715		
V1	715	900		

Note:  
 Tolerance of Luminous Intensity: ±11%

### Bin Range of Dominant Wavelength

Bin Code	Min.	Max.	Unit	Condition
D3	585.5	588.5	nm	I <sub>F</sub> =20mA
D4	588.5	591.5		
D5	591.5	594.5		

Note:  
 Tolerance of Dominant Wavelength: ±1nm

### Bin Range of Forward Voltage

Bin Code	Min.	Max.	Unit	Condition
0	1.75	1.95	V	I <sub>F</sub> =20mA
1	1.95	2.15		
2	2.15	2.35		

Note:  
 Tolerance of Forward Voltage: ±0.1V

**Typical Electro-Optical Characteristics Curves**

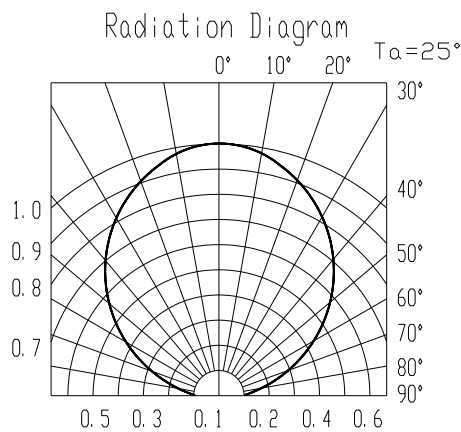
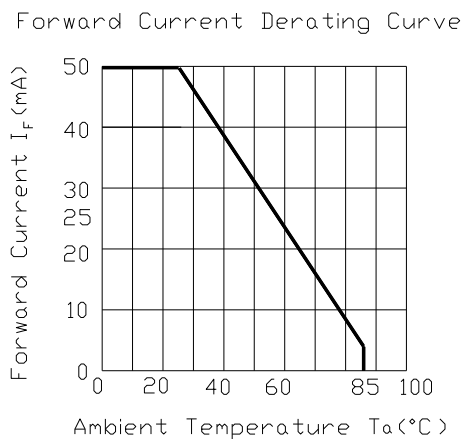
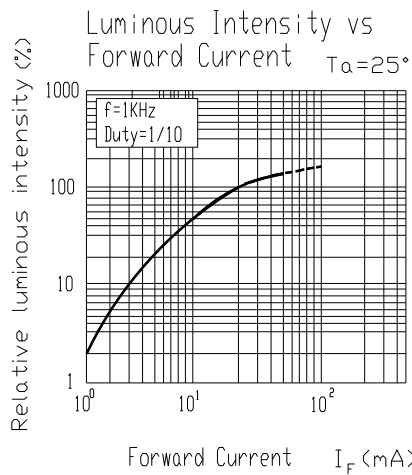
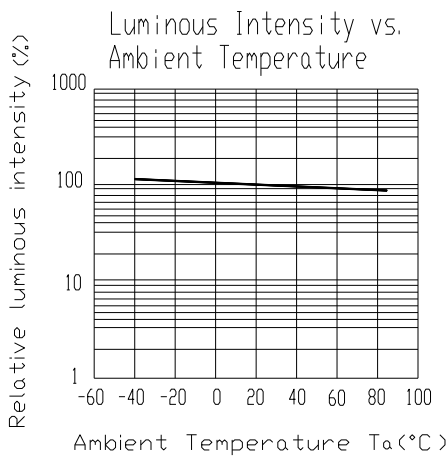
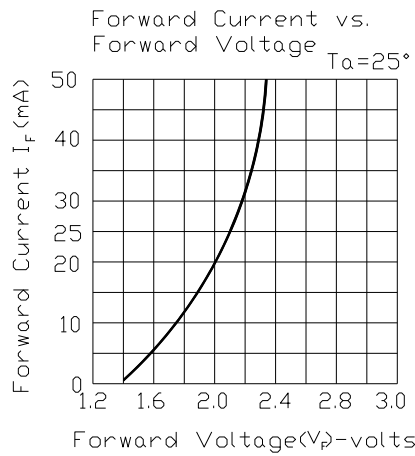
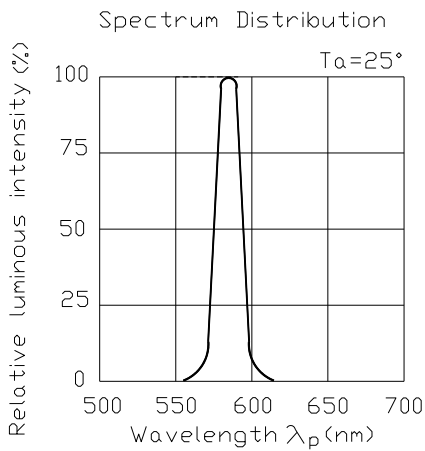

### Package Dimension

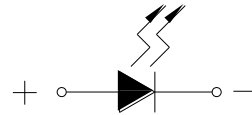
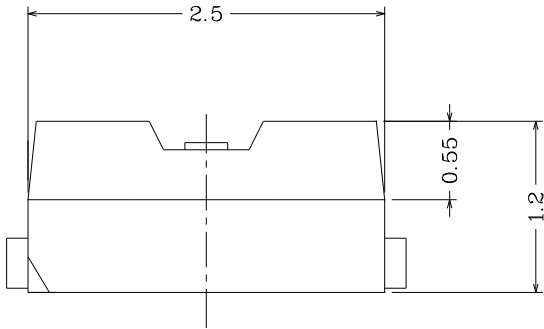

Polarity

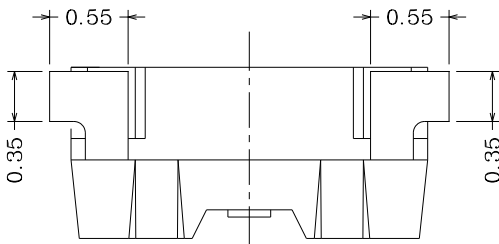
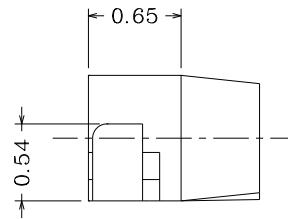
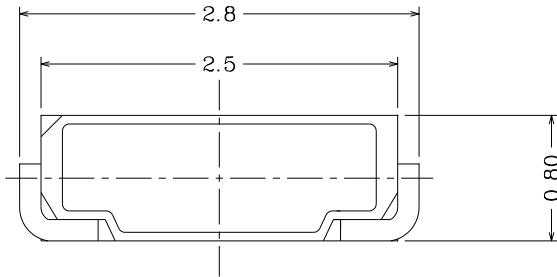

Recommended soldering pad design

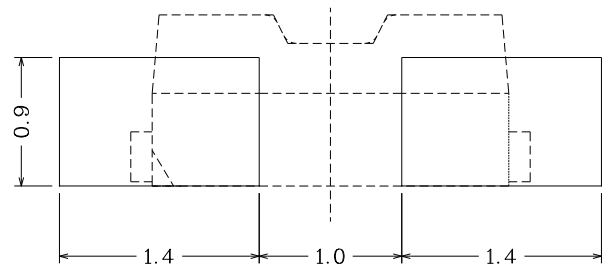

Note: Tolerances unless mentioned  $\pm 0.1\text{mm}$ . Unit = mm

## Moisture Resistant Packing Materials

### Label Explanation



- CPN: Customer's Product Number
- P/N: Product Number
- QTY: Packing Quantity
- CAT: Luminous Intensity Rank
- HUE: Dom. Wavelength Rank
- REF: Forward Voltage Rank
- LOT No: Lot Number

### Reel Dimensions

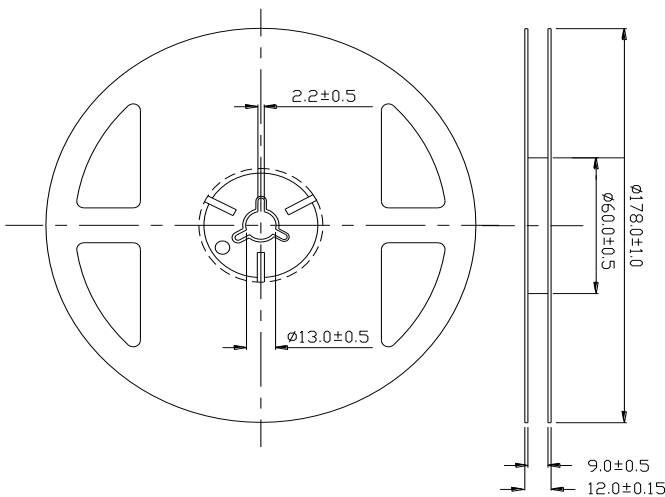

### Carrier Tape Dimensions: Loaded Quantity 2000 pcs Per Reel

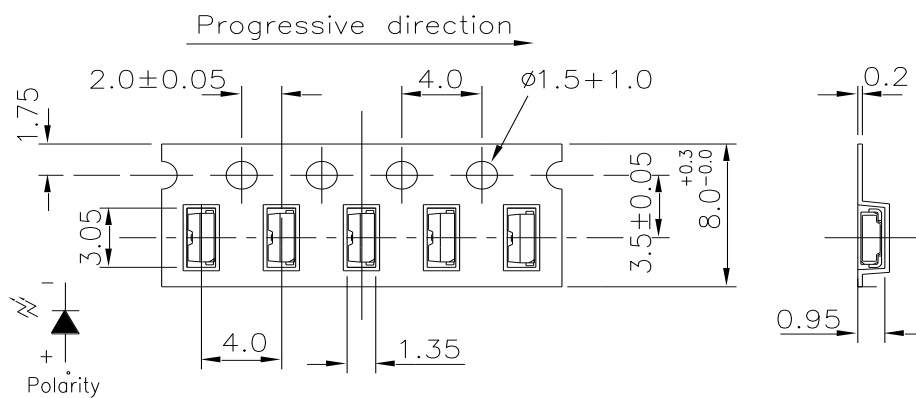

Note: Tolerances unless mentioned  $\pm 0.1$ mm. Unit = mm

### Moisture Resistant Packing Process

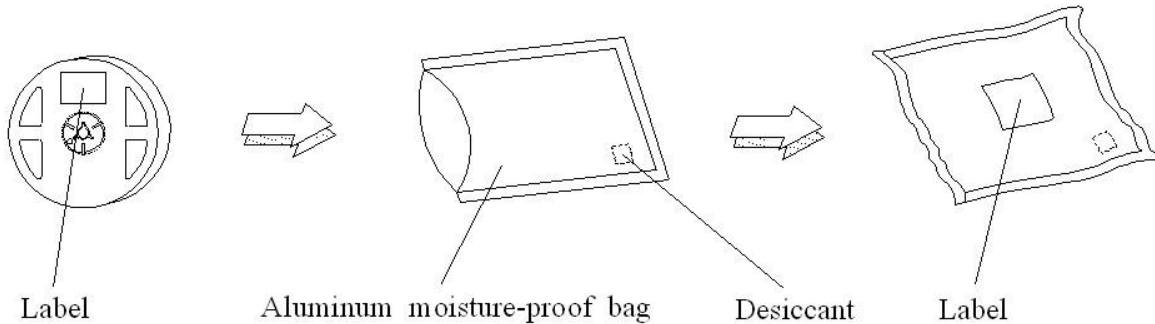

Note: Tolerances unless mentioned  $\pm 0.1\text{mm}$ . Unit = mm

### Precautions for Use

#### 1. Over-current-proof

1.1 Customer must apply resistors for protection, otherwise slight voltage shift will cause big current change ( Burn out will happen ).

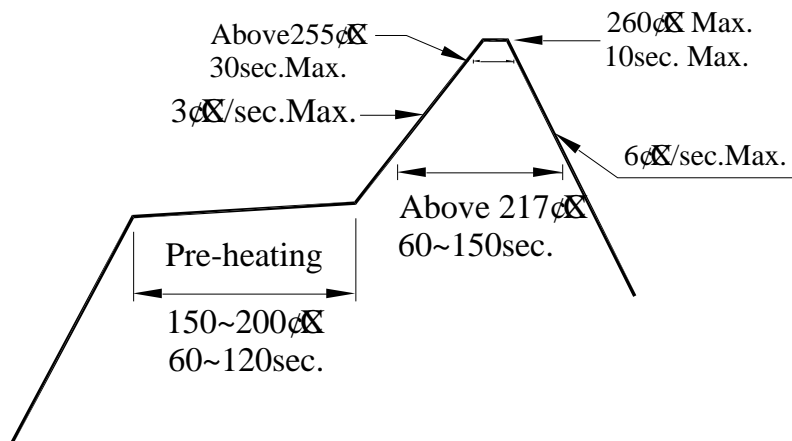

#### 2. Storage

- 2.1 Moisture proof bag should only be opened immediately prior to usage.
- 2.2 Environment should be less than 30°C and 60% RH when moisture proof bag is opened.
- 2.3 After opening the package MSL Conditions stated on page 1 of this spec should not be exceeded.
- 2.4 If the moisture sensitivity card indicates higher than acceptable moisture, the component should be baked at min. 60deg +/-5deg for 24 hours.

#### 3. Soldering Condition

- 3.1 Pb-free solder temperature profile
- 3.2 Reflow soldering should not be done more than two times.
- 3.3 When soldering, do not put stress on the LEDs during heating.
- 3.4 After soldering, do not warp the circuit board.

#### 4. Soldering Iron

Each terminal is to go to the tip of soldering iron temperature less than 350°C for 3 seconds within once in less



than the soldering iron capacity 25W. Leave two seconds and more intervals, and do soldering of each terminal. Be careful because the damage of the product is often started at the time of the hand solder.

#### 5. Repairing

Repair should not be done after the LEDs have been soldered. When repairing is unavoidable, a double-head soldering iron should be used (as below figure). It should be confirmed beforehand whether the characteristics of the LEDs will or will not be damaged by repairing.

## Application Restrictions

High reliability applications such as military/aerospace, automotive safety/security systems, and medical equipment may require different product. If you have any concerns, please contact Everlight before using this product in your application. This specification guarantees the quality and performance of the product as an individual component. Do not use this product beyond the specification described in this document.

## Revision History

Rev.	Modified date	File modified contents
1	2014/05/08	New Spec