

SMD ■ B EAST20128GA0-AM

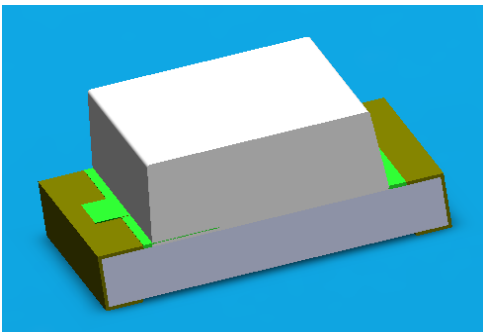

Features

- RoHS compliant
- Chip LED package.
- Colorless clear resin.
- Wide viewing angle 130°.
- Brightness: 11.2 to 28.0 mcd at 20mA.
- Qualification according to AEC-Q101.
- Precondition: Bases on JEDEC J-STD 020 Level 3.
- Automotive reflow profile (IR reflow or wave soldering)
- Compliance with EU REACH.
- Compliance Halogen Free .(Br <900 ppm ,Cl <900 ppm , Br+Cl < 1500 ppm).

Applications

- Automotive backlighting or indicator: Dashboard, switch, audio and video equipments...etc.
- Backlight: LCD, switches, symbol, mobile phone and illuminated advertising.
- Display for indoor and outdoor application.
- Ideal for coupling into light guides.
- Substitution of traditional light.
- Optical indicator.
- General applications.

Device Selection Guide

Chip Materials	Emitted Color	Resin Color
AlGaInP	Pale Green	Water Clear

Absolute Maximum Ratings (Ta=25°C)

Parameter	Symbol	Rating	Unit
Reverse Voltage	V_R	12	V
Forward Current	I_F	30	mA
Peak Forward Current (Duty 1/10 @1KHz)	I_{FP}	60	mA
Power Dissipation	P_d	60	mW
Junction Temperature	T_j	125	°C
Operating Temperature	T_{opr}	-40 ~ +100	°C
Storage Temperature	T_{stg}	-40 ~ +110	°C
Thermal Resistance	$R_{th\ J-A}$	800	K/W
	$R_{th\ J-S}$	450	K/W
ESD (Classification acc. AEC Q101)	ESD_{HBM}	2000	V
	ESD_{MM}	200	V
Soldering Temperature	T_{sol}	Reflow Soldering : 260 °C for 30 sec. Hand Soldering : 350 °C for 3 sec.	

Electro-Optical Characteristics (Ta=25°C)

Parameter	Symbol	Min.	Typ.	Max.	Unit	Condition
Luminous Intensity	Iv	11.20	-----	28.00	mcd	I _F =20mA
Viewing Angle	2θ _{1/2}	-----	130	-----	deg	I _F =20mA
Peak Wavelength	λ _p	-----	561	-----	nm	I _F =20mA
Dominant Wavelength	λ _d	557	----	564	nm	I _F =20mA
Spectrum Radiation Bandwidth	Δλ	-----	20	-----	nm	I _F =20mA
Forward Voltage	V _F	1.70	----	2.30	V	I _F =20mA
Reverse Current	I _R	-----	-----	10	μA	V _R =12V
Temperature coefficient of λ _p	TC _{λ_p}	-----	0.06	-----	nm/K	I _F =20mA
Temperature coefficient of λ _d	TC _{λ_d}	-----	0.4	-----	nm/K	I _F =20mA
Temperature coefficient of V _F	TC _V	-----	-2.3	-----	mV/K	I _F =20mA

Note:

1. Tolerance of Luminous Intensity: ±11%
2. Tolerance of Dominant Wavelength: ±1nm
3. Tolerance of Forward Voltage: ±0.1V

Bin Range of Luminous Intensity

Bin Code	Min.	Max.	Unit	Condition
L1	11.20	14.00	mcd	I _F =20mA
L2	14.00	18.00		
M1	18.00	22.40		
M2	22.40	28.00		

Note:

Tolerance of Luminous Intensity: ±11%

Bin Range of Dominant Wavelength

Bin Code	Min.	Max.	Unit	Condition
1	557	561	nm	I _F =20mA
2	561	564		

Note:

Tolerance of Dominant Wavelength: ±1nm

Typical Electro-Optical Characteristics Curves

Typical Curve of Spectral Distribution

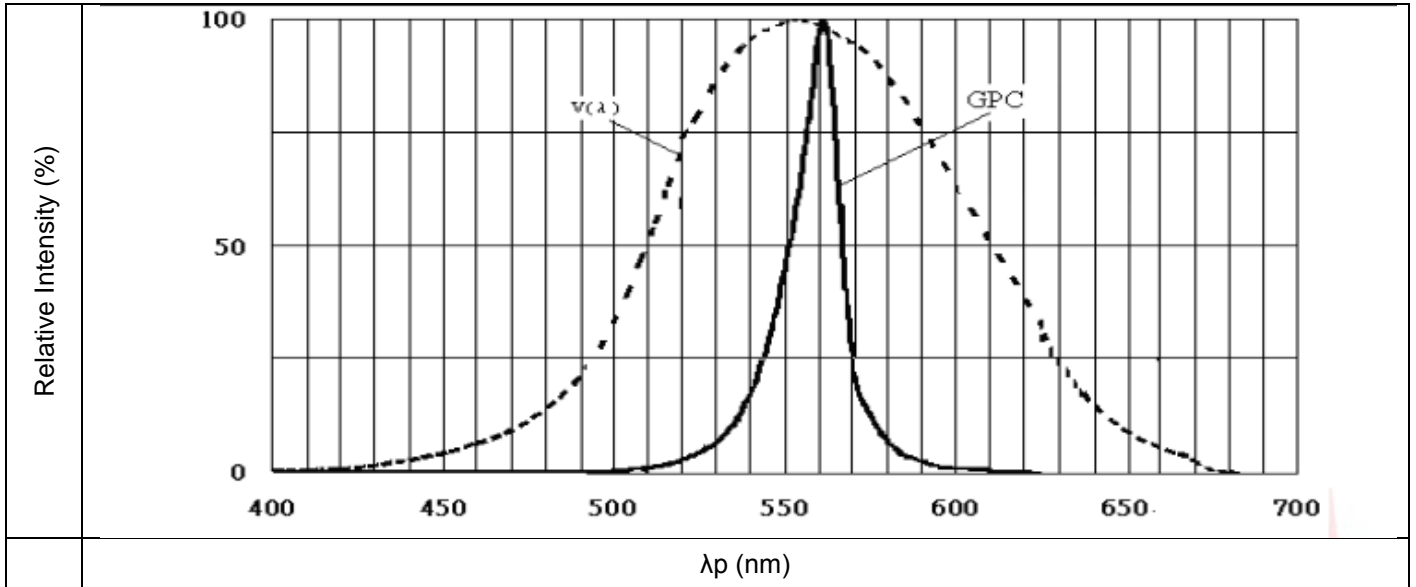

Note: $V(\lambda)$ =Standard eye response curve; $I_F = 20\text{mA}$

Diagram Characteristics of Radiation

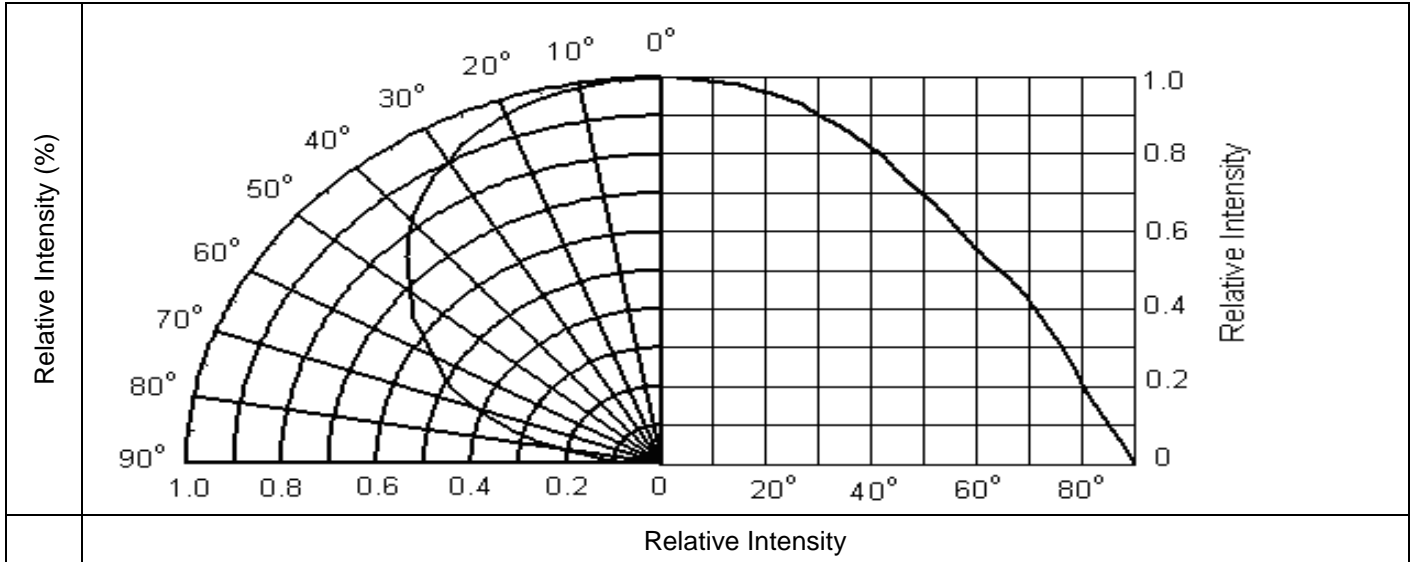

Forward Current vs. Forward Voltage
($T_a=25^\circ\text{C}$)

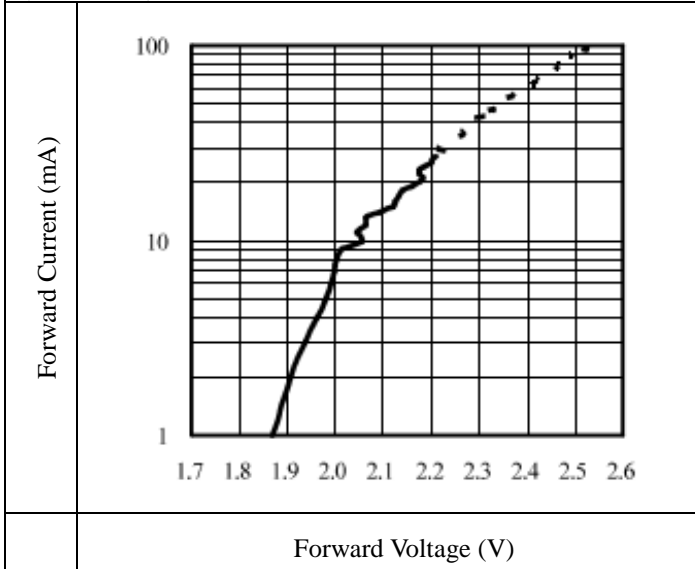

Dominant Wavelength vs. Forward Current
($T_a=25^\circ\text{C}$)

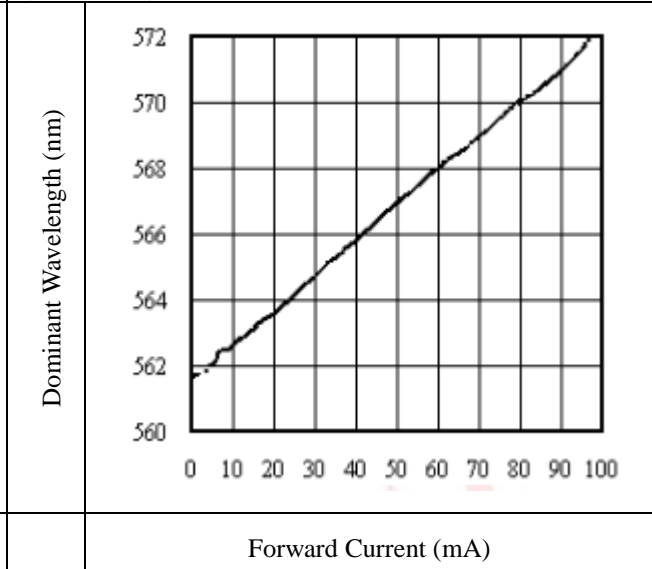

Forward Voltage (V)

Forward Current (mA)

Relative Luminous Intensity vs. Forward Current
($T_a=25^\circ\text{C}$)

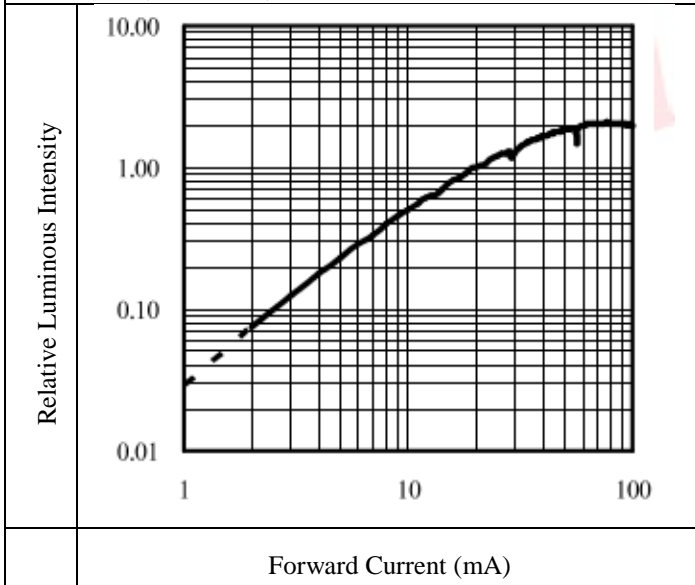

Forward Current (mA)

Max. Permissible Forward Current
($T_a=25^\circ\text{C}$)

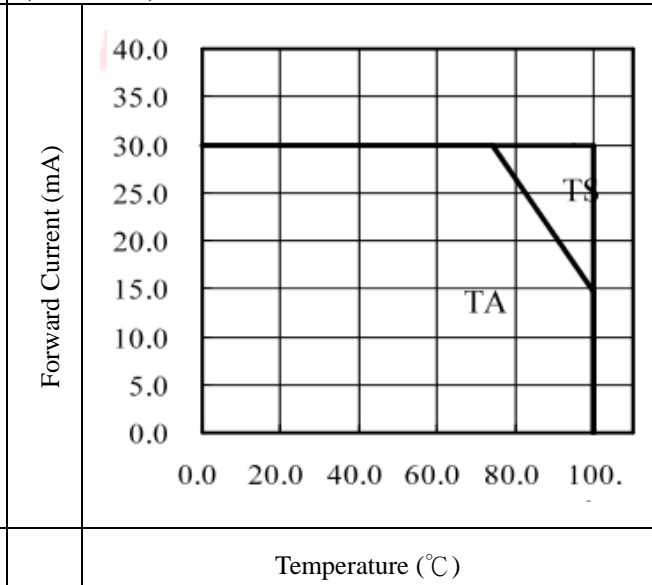

Temperature ($^\circ\text{C}$)

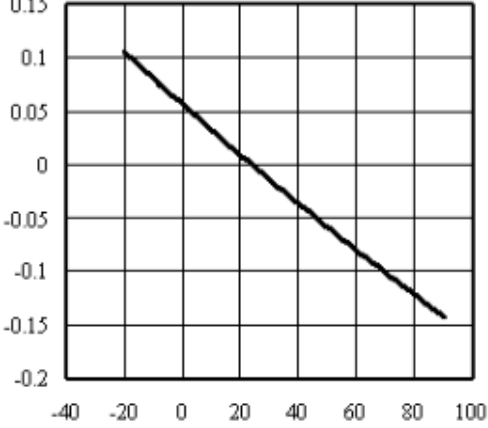
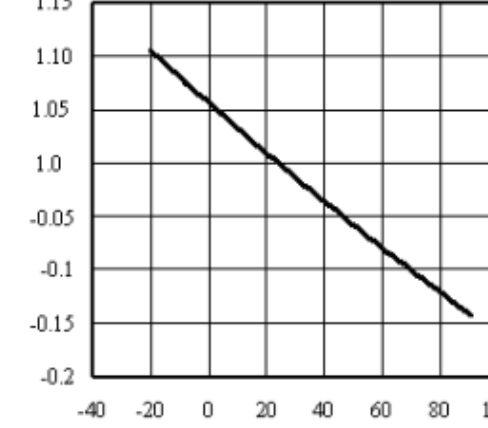
Relative Luminous Intensity vs. Junction Temperature		Relative Forward Voltage vs. Junction Temperature	
Relative Luminous Intensity		Relative Forward Voltage	
	Junction Temperature (°C)		Junction Temperature (°C)
Note: $f(T_j) = I_v - I_v(25^\circ\text{C}); I_F = 20\text{mA}$		Note: $\Delta V_F = V_F - V_F(25^\circ\text{C}) = f(T_j); I_F = 20\text{mA}$	

Package Dimension

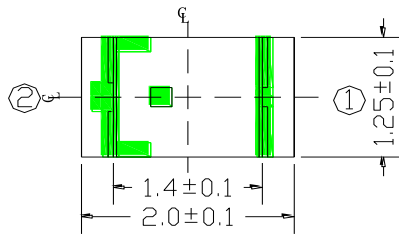

TOP

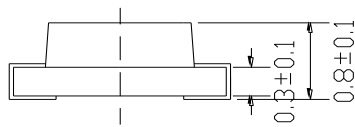
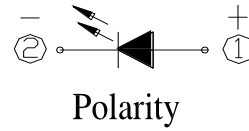

Side

Recommend Sodering Pad

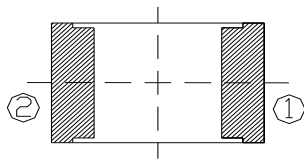

Bottom

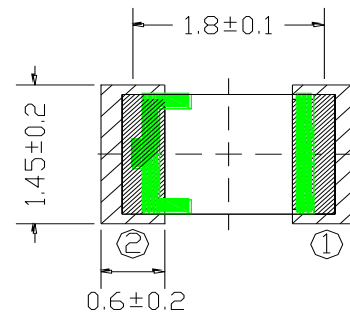

Suggested pad dimension is just for reference only.
Please modify the pad dimension based on individual need.

Note: Tolerances unless mentioned ± 0.1 mm. Unit = mm

Moisture Resistant Packing Materials

Label Explanation



Label Explanation

- **CPN:** Customer's Product Number
- **P/N:** Product Number
- **QTY:** Packing Quantity
- **CAT:** Luminous Intensity Rank
- **HUE:** Dom. Wavelength Rank
- **REF:** Forward Voltage Rank
- **LOT No:** Lot Number

Reel Dimensions

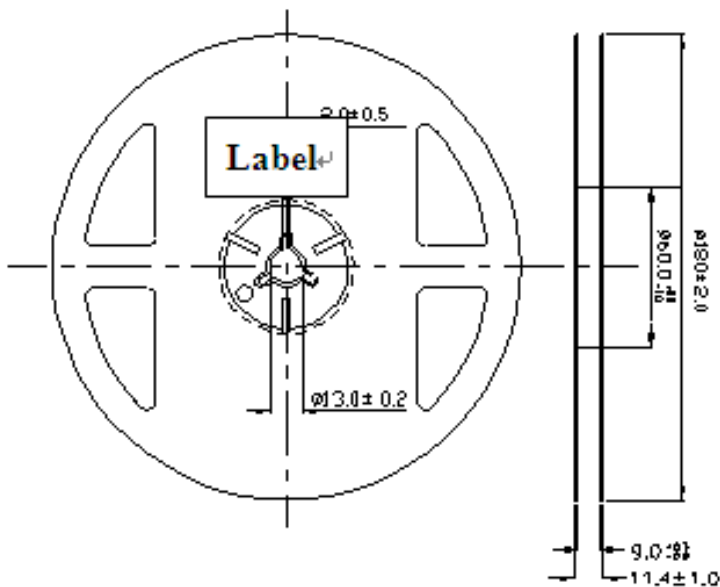

Note: The tolerances unless mentioned is $\pm 0.1\text{mm}$, Unit = mm

Carrier Tape Dimensions: Loaded Quantity 3000 pcs Per Reel

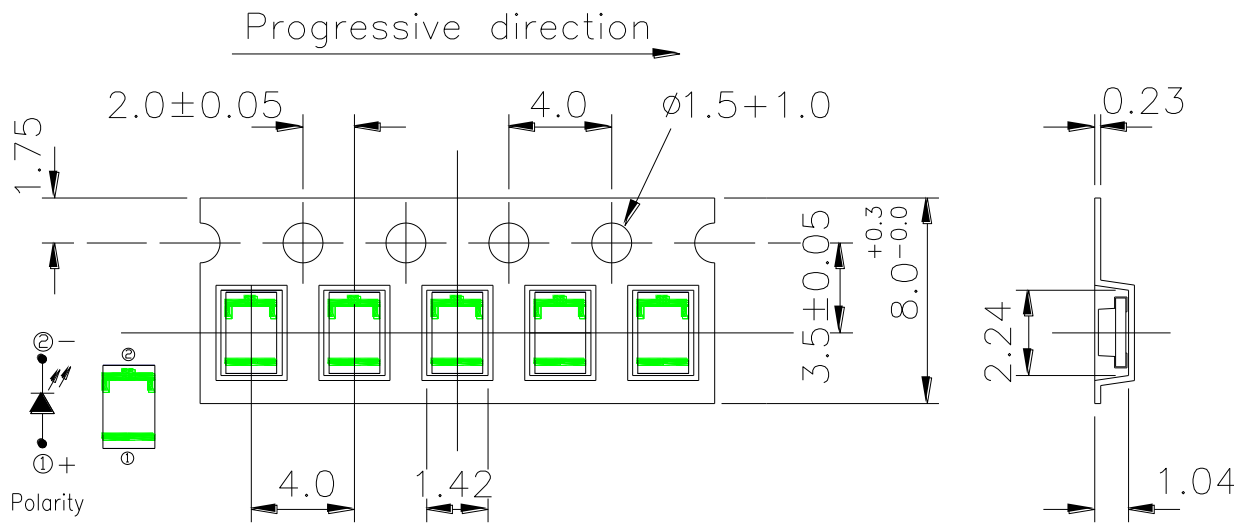

Note: Tolerances unless mentioned ±0.1mm. Unit = mm

Moisture Resistant Packing Process

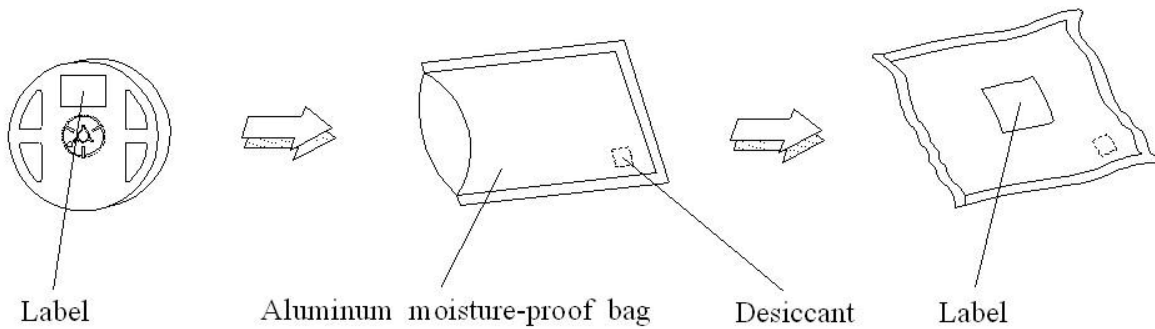

Precautions for Use

1. Soldering Condition (Reference: IPC/JEDEC J-STD-020D)

(A) IR reflow

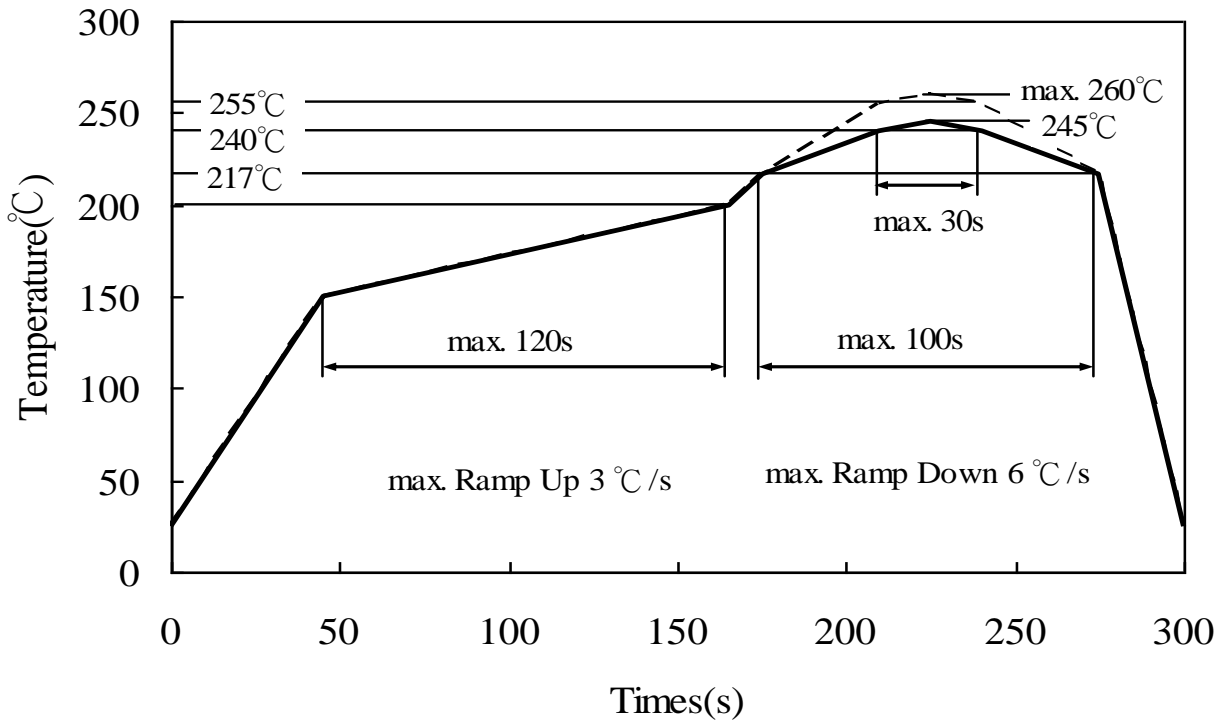

(B) Wave Soldering reflow

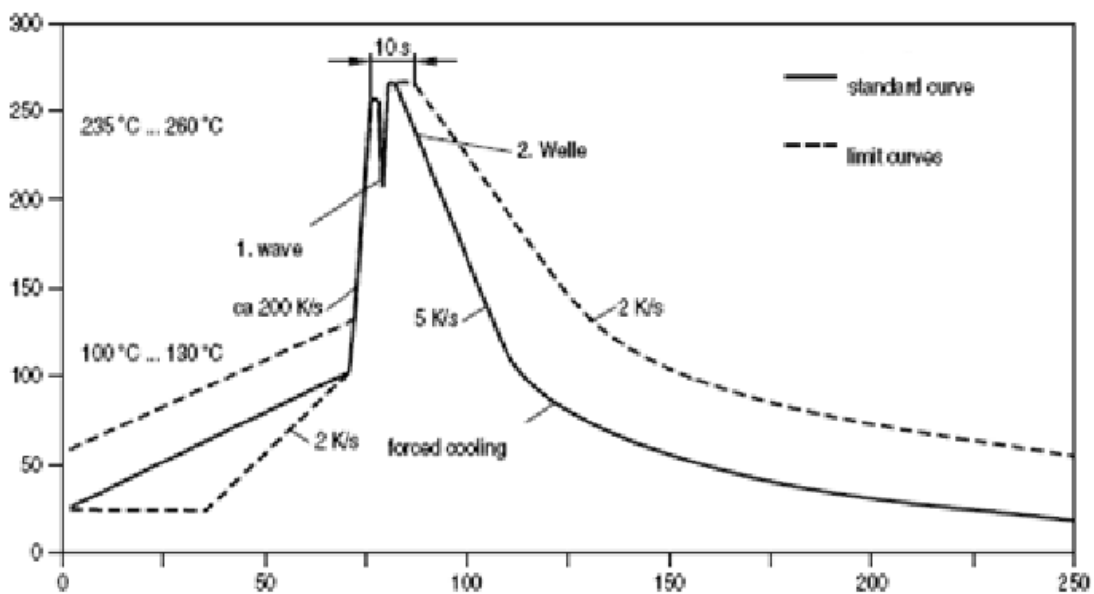

(B) Recommend soldering pad

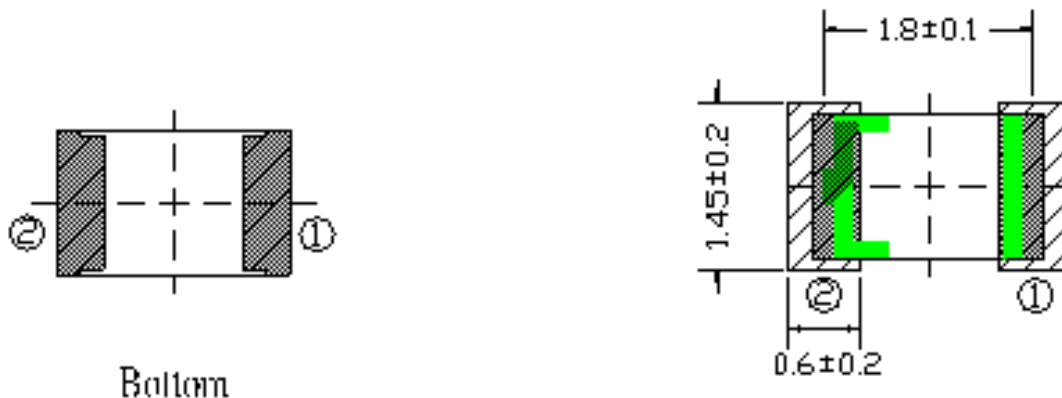

Note: Tolerances unless mentioned ± 0.1 mm. Unit = mm

2. Current limiting

A resistor should be used to limit current spikes that can be caused by voltage fluctuations. Otherwise damage could occur.

3. Storage

3.1 Moisture proof bag should only be opened immediately prior to usage.

3.2 Environment should be less than 30°C and 90% RH when moisture proof bag is opened.

3.3 After opening the package MSL Conditions stated on page 1 of this spec should not be exceeded.

3.4 If the moisture sensitivity card indicates higher than acceptable moisture, the component should be baked at min. 60°deg $\pm 5^{\circ}\text{deg}$ for 25 hours.

4. Iron Soldering

Hand soldering is not recommended for regular production. These guidelines are for rework only. Soldering iron tip should contact each terminal no more than 3 sec at 350°C , using soldering iron with nominal power less than 25W. Allow min. 2 sec. between soldering intervals.

5. Usage

Do not exceed the values given in this specification.

Application Restrictions

1. High reliability applications such as military/aerospace, automotive safety/security systems, and medical equipment may require different product. If you have any concerns, please contact Everlight before using this product in your application. This specification guarantees the quality and performance of the product as an individual component. Do not use this product beyond the specification described in this document.