

SMD ■ EAST1616RGBC0

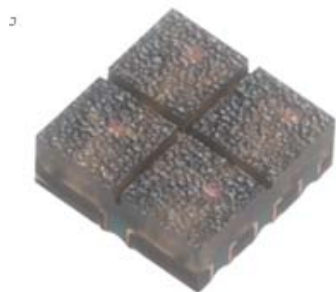

Features

- Package in 8mm tape on 7" diameter reel
- Compatible with automatic placement equipment
- Compatible with infrared and vapor phase reflow
- Solder process
- Full-color type
- Pb-free
- Component solderable surface finish is Gold
- The Product itself will remain within RoHS compliant version
- Compliance with EU REACH
- Compliance Halogen Free. (Br<900ppm, Cl<900ppm, Br+Cl<1500ppm)

Description

The EAST1616RGBC0 SMD LED is much smaller than lead frame type components, thus enable smaller board size, higher packing density, reduced storage space and finally smaller equipment to be obtained. Moreover, with its black PCB, the EAST1616RGBC0 possess an ideal solution for high-contrast and high-resolution indoor signage display.

Applications

- Indoor signage display applications
- Indoor decorating and entertainment design
- Flat backlight for LCD, switch and symbol
- Indicator and backlighting for all consumer electronics

Device Selection Guide

Chip Materials	Emitted Color	Resin Color
AlGaInP	Brilliant Red	
InGaN	Brilliant Green	Black Surface Diffused
InGaN	Brilliant Blue	

Absolute Maximum Ratings (Ta=25°C)

Parameter	Symbol	Rating	Unit
Forward Current	I _F	R6:10 GA:10 BD:10	mA
Peak Forward Current (Duty 1/10 @1KHz)	I _{FP}	R6:20 GA:20 BD:20	mA
Power Dissipation	P _d	R6:24 GA:31 BD:31	mW
Junction Temperature	T _j	100	°C
Operating Temperature	T _{opr}	-40 ~ +85	°C
Storage Temperature	T _{stg}	-40 ~ +90	°C
ESD (Classification acc. AEC Q101)	ESD _{HBM}	R:2000 G:1000 B:1000	V
Soldering Temperature	T _{sol}	Reflow Soldering : 260 °C for 10 sec. Hand Soldering : 350 °C for 3 sec.	

Electro-Optical Characteristics (Ta=25°C)

Parameter	Symbol	Min.	Typ.	Max.	Unit	Condition	
Luminous Intensity	Iv	R6	15.0	-----	30.0	mcd	I _F =5mA
		GA	30.0	-----	60.0		I _F =3mA
		BD	3.0	-----	10.0		I _F =2mA
Viewing Angle	2θ _{1/2}	-----	120	-----	deg	I _F =5mA I _F =3mA I _F =2mA	
Peak Wavelength	λ _p	R6		625		nm	I _F =5mA
		GA	-----	525	-----		I _F =3mA
		BD		465			I _F =2mA
Dominant Wavelength	λ _d	R6	619.0		624.0	nm	I _F =5mA
		GA	520.0	-----	540.0		I _F =3mA
		BD	460.0		475.0		I _F =2mA
Spectrum Radiation Bandwidth	Δλ	R6		20		nm	I _F =5mA
		GA	-----	25	-----		I _F =3mA
		BD		25			I _F =2mA
Forward Voltage	V _F	R6	1.70	-----	2.40	V	I _F =5mA
		GA	2.30	-----	3.10		I _F =3mA
		BD	2.30	-----	3.10		I _F =2mA
Reverse Current ⁴	I _R	-----	-----	10	μA	V _R =5V	

Note:

1. Tolerance of Luminous Intensity: ±10%
2. Tolerance of Dominant Wavelength: ±1nm
3. Tolerance of Forward Voltage: ±0.1V
4. Set the product level as: brightness = 1:1.50±0.02, wavelength for R = 5 nm, G/B = 3nm
Specific requirements will be subject to customer consultation
5. Order quantity is within 25kk, a single bin shipment is available.
If an order quantity is more than 25kk, the shipment will be provided as adjacent bins of wavelength.
6. Only for Electronic test

Floating Bin(R6) Bin Range of Luminous Intensity

Bin Code	Min.	Max.	Unit	Condition
R	15.0	30.0	mcd	I _F =5mA

Bin Range of Dominant Wavelength

Bin Code	Min.	Max.	Unit	Condition
R	619.0	624.0	nm	I _F =5mA

Bin Range of Dominant Voltage

Bin Code	Min.	Max.	Unit	Condition
R	1.7	2.4	v	I _F =5mA

Note:

1. Tolerance of Luminous Intensity: $\pm 10\%$
2. Tolerance of Dominant Wavelength: $\pm 1\text{nm}$
3. Tolerance of Forward Voltage: $\pm 0.01\text{V}$
4. Set the product level as: brightness = 1:1.50 \pm 0.02, wavelength for R = 5 nm, G/B = 3nm
Specific requirements will be subject to customer consultation
5. Order quantity is within 25kk, a single bin shipment is available.
If an order quantity is more than 25kk, the shipment will be provided as adjacent bins of wavelength.
6. Only for Electronic test

Floating Bin(GA) Bin Range of Luminous Intensity

Bin Code	Min.	Max.	Unit	Condition
G	30.0	60.0	mcd	I _F =3mA

Bin Range of Dominant Wavelength

Bin Code	Min.	Max.	Unit	Condition
G	520.0	540.0	nm	I _F =3mA

Bin Range of Dominant Voltage

Bin Code	Min.	Max.	Unit	Condition
G	2.30	3.10	v	I _F =3mA

Note:

- 1.Tolerance of Luminous Intensity: $\pm 10\%$
- 2.Tolerance of Dominant Wavelength: $\pm 1\text{nm}$
3. Tolerance of Forward Voltage: $\pm 0.01\text{V}$
4. Set the product level as: brightness = 1:1.50 \pm 0.02, wavelength for R = 5 nm, G/B = 3nm
Specific requirements will be subject to customer consultation
- 5.Order quantity is within 25kk, a single bin shipment is available.
If an order quantity is more than 25kk, the shipment will be provided as adjacent bins of wavelength.
- 6.Only for Electronic test

Floating Bin(BD) Bin Range of Luminous Intensity

Bin Code	Min.	Max.	Unit	Condition
B	3.0	10.0	mcd	I _F =2mA

Bin Range of Dominant Wavelength

Bin Code	Min.	Max.	Unit	Condition
B	460.0	475.0	nm	I _F =2mA

Bin Range of Dominant Voltage

Bin Code	Min.	Max.	Unit	Condition
B	2.30	3.10	v	I _F =2mA

Note:

- 1.Tolerance of Luminous Intensity: $\pm 10\%$
- 2.Tolerance of Dominant Wavelength: $\pm 1\text{nm}$
3. Tolerance of Forward Voltage: $\pm 0.01\text{V}$
4. Set the product level as: brightness = 1:1.50 \pm 0.02, wavelength for R = 5 nm, G/B = 3nm
Specific requirements will be subject to customer consultation
- 5.Order quantity is within 25kk, a single bin shipment is available.
If an order quantity is more than 25kk, the shipment will be provided as adjacent bins of wavelength.
- 6.Only for Electronic test

Typical Electro-Optical Characteristics Curves

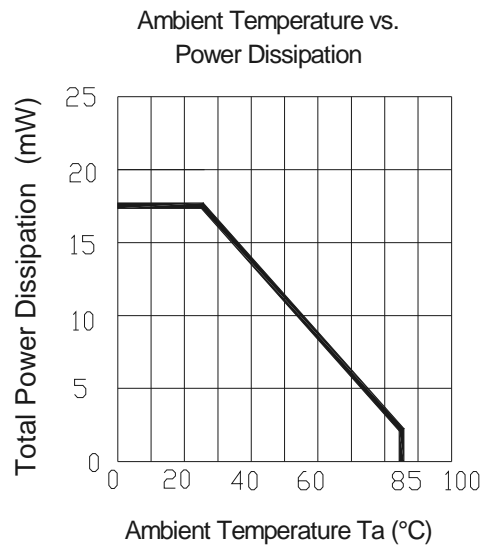
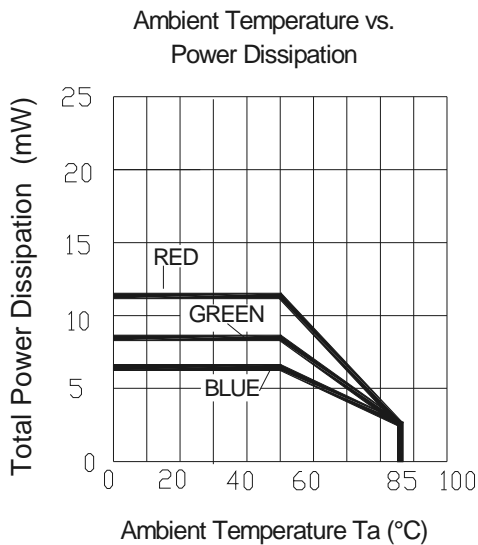
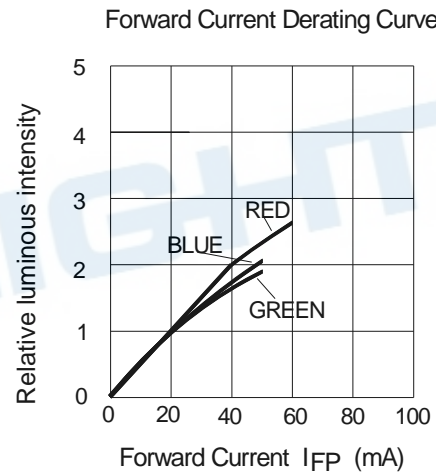
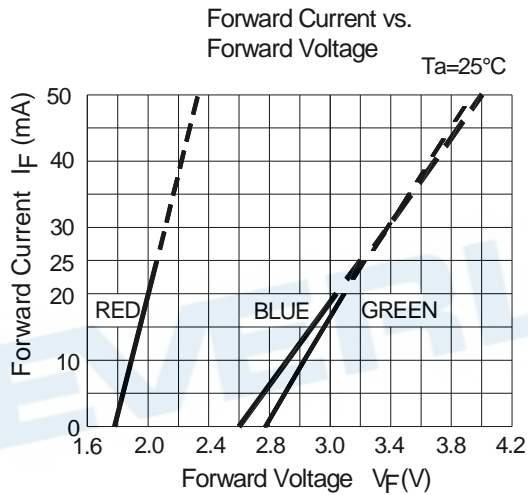
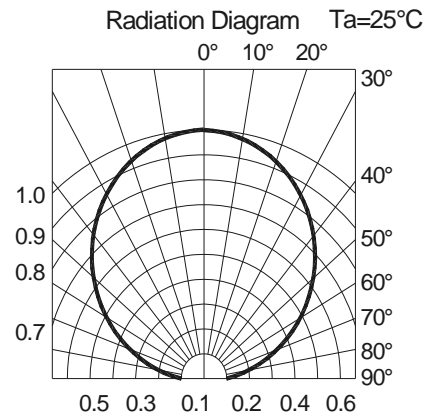
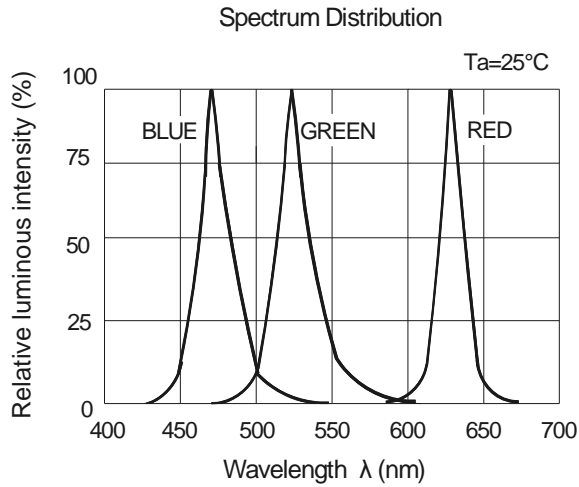

Package Dimension

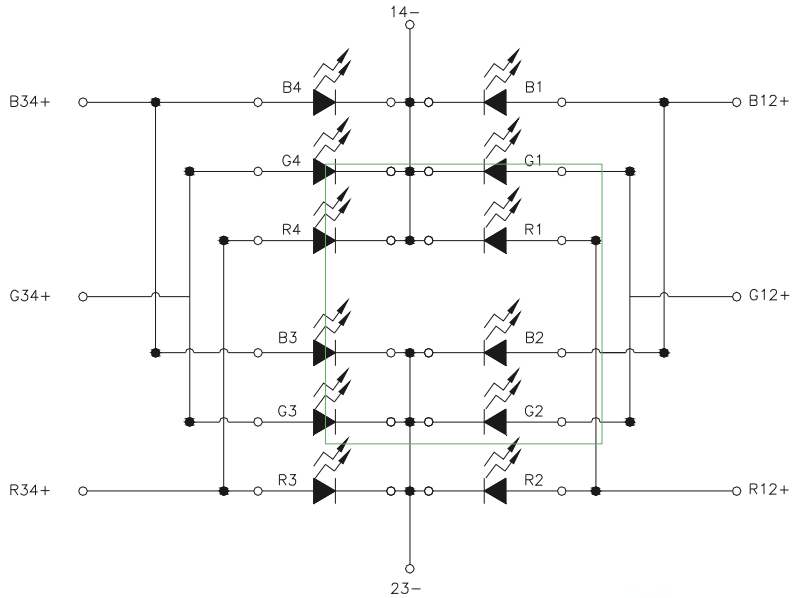
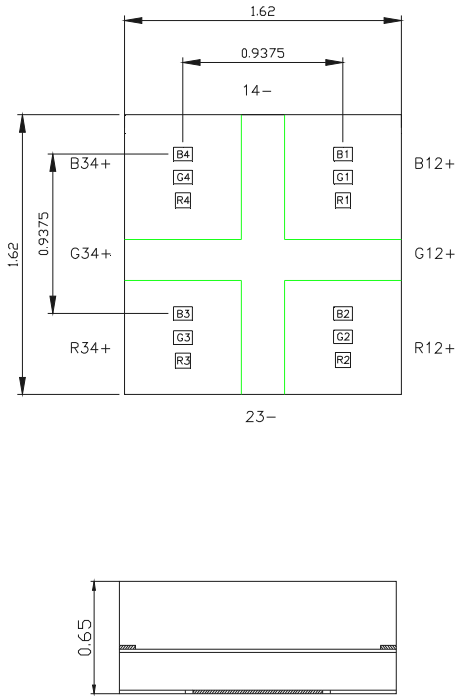

Polarity

Side

Recommend Soldering Pad

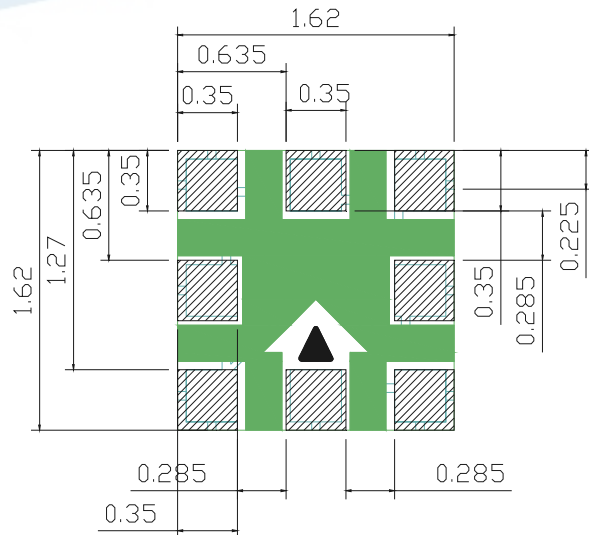
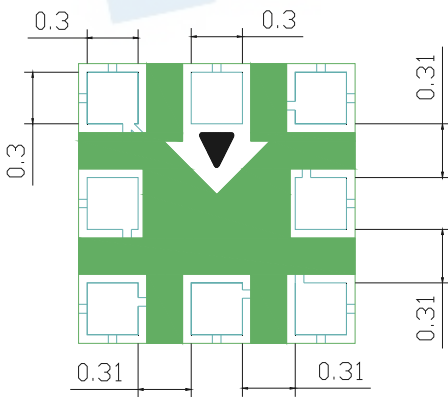

Suggested pad dimension is just for reference only.
Please modify the pad dimension based on individual need.

Note: Tolerances unless mentioned $\pm 0.1\text{mm}$. Unit = mm

Moisture Resistant Packing Materials

Label Explanation

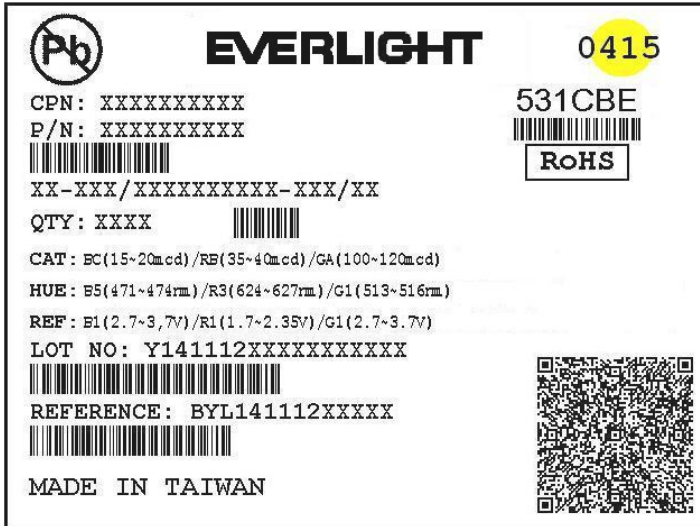

- PN: Customer's Product Number
- SPECIFICATION: LED
- PO TYPE: the label's function
- LOT No: Lot Number
- QTY: Packing Quantity
- VENDOR P/N: express the product type
- VENDOR/Code: EVERLIGHT'code

Reel Dimensions

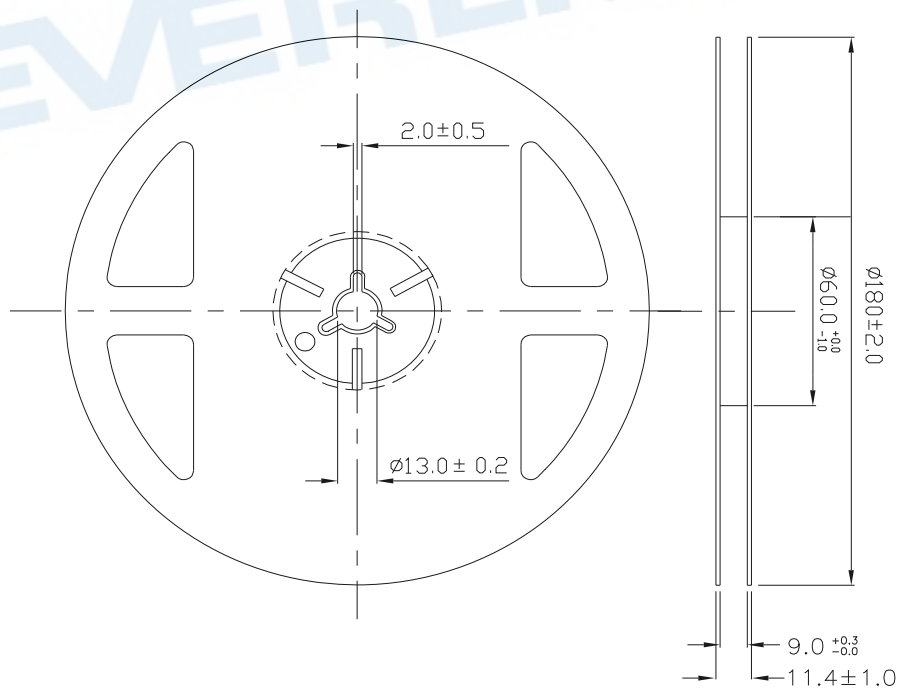

Carrier Tape Dimensions:

The minimum quantity of packing is 4000 pcs per reel.

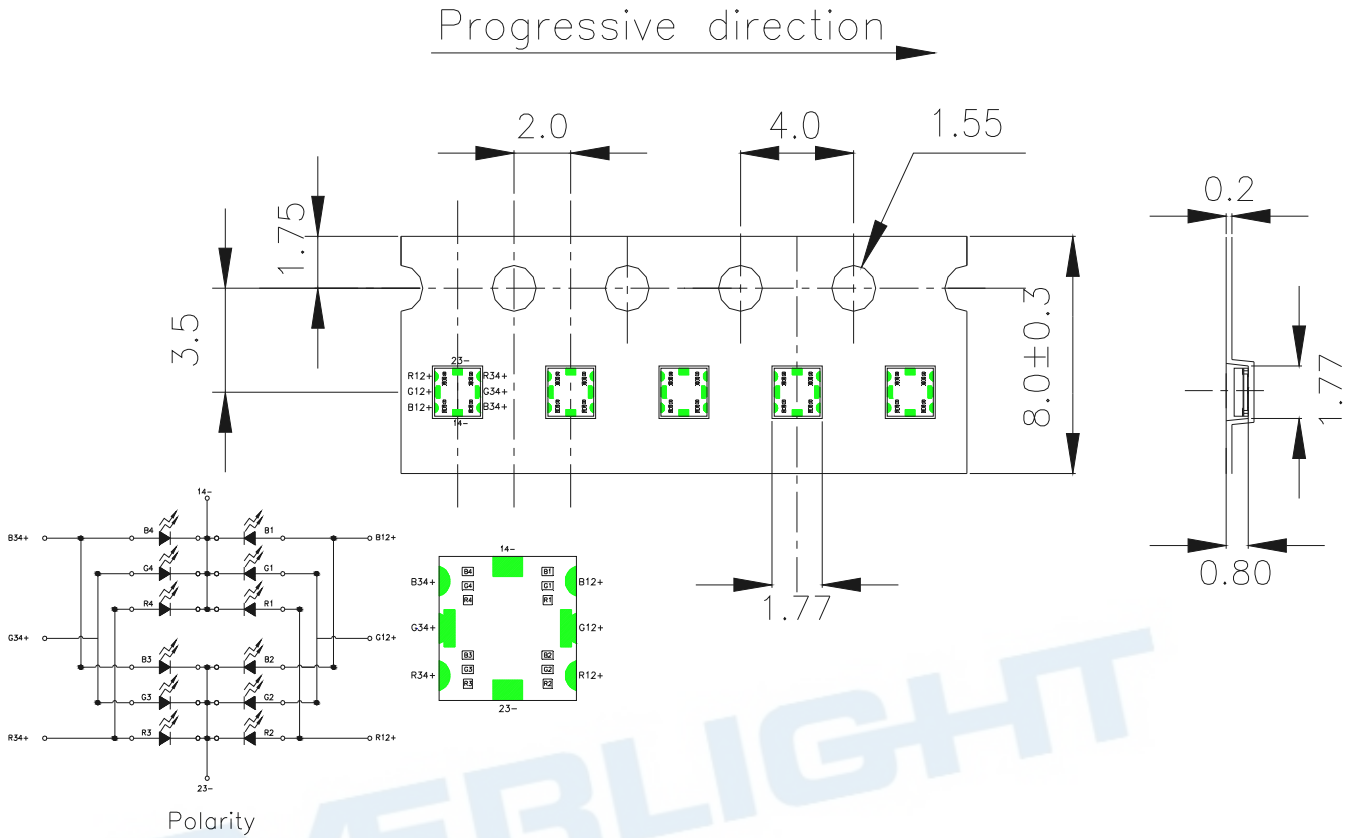

Note: Tolerances unless mentioned ± 0.1 mm. Unit = mm

Moisture Resistant Packing Process

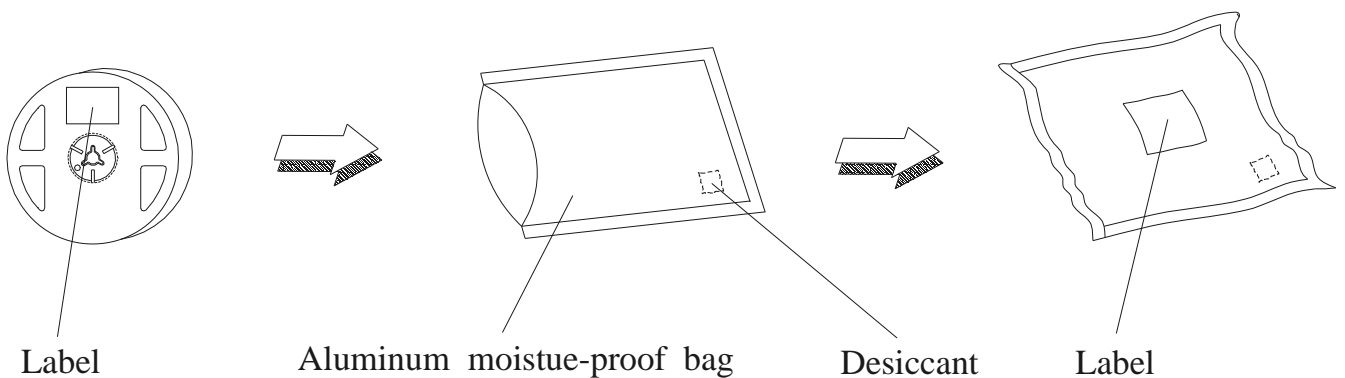

Note: Tolerances unless mentioned ± 0.1 mm. Unit = mm

Precautions for Use

1. Over-current-proof

Customer must apply resistors for protection, otherwise slight voltage shift will cause big current change (Burn out will happen).

2. Storage

2.1 Do not open moisture proof bag before the products are ready to use.

2.2 Before opening the package: The LEDs should be kept at 30°C or less and 90%RH or less.

2.3 After opening the package: The LED's floor life is 168Hrs under 30°C or less and 60% RH or less. If unused LEDs remain, it should be stored in moisture proof packages.

2.4 If the moisture absorbent material (silica gel) has faded away or the LEDs have exceeded the storage time, baking treatment should be performed using the following conditions.

Baking treatment : 60±5°C for 24 hours.

2.5 Before using LEDs, baking treatment should be implemented based on the following conditions: pre-curing at 60±5°C for 24 hours or 125±5°C for 3 hours.

3. Soldering Condition

3.1 Pb-free solder temperature profile

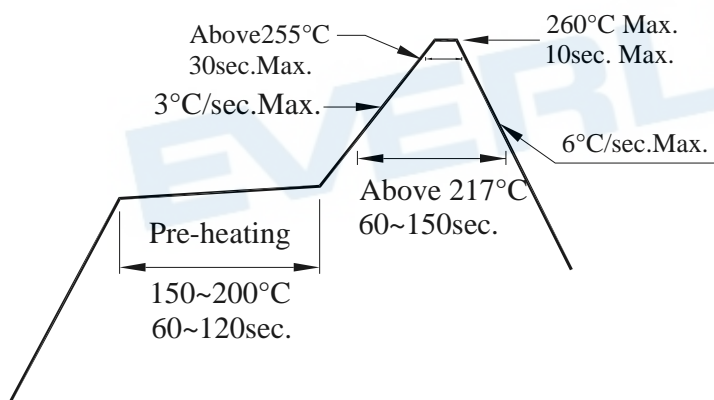

3.2 Reflow soldering should not be done more than two times.

3.3 When soldering, do not put stress on the LEDs during heating.

3.4 After soldering, do not warp the circuit board.

4. Soldering Iron

Each terminal is to go to the tip of soldering iron temperature less than 350°C for 3 seconds within once in less than the soldering iron capacity 25W. Leave two seconds and more intervals, and do soldering of each terminal. Be careful because the damage of the product is often started at the time of the hand solder.

5.Repairing

Repair should not be done after the LEDs have been soldered. When repairing is unavoidable, a double-head soldering iron should be used (as below figure). It should be confirmed beforehand whether the characteristics of the LEDs will or will not be damaged by repairing.

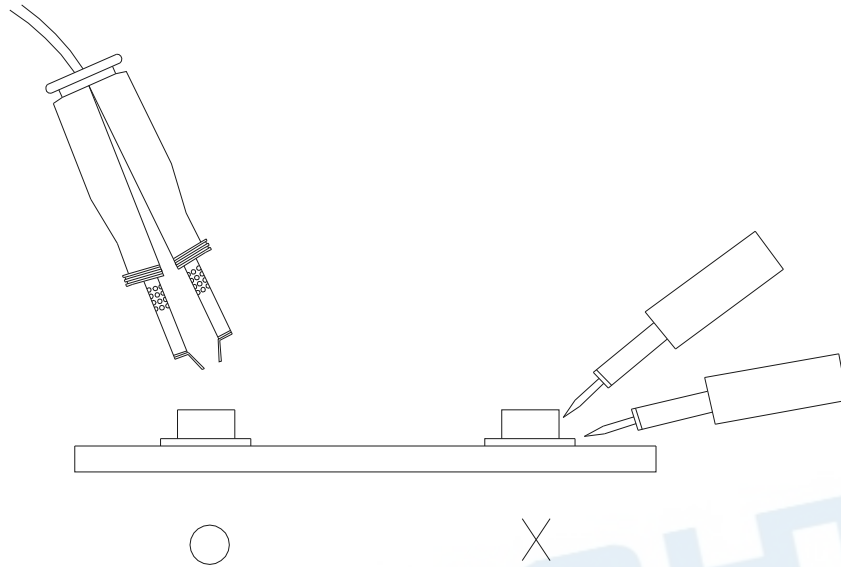

6.Directions for use

The LEDs should be operated with forward bias. The driving circuit must be designed so that the LEDs are not subjected to forward or reverse voltage while it is off. If reverse voltage is continuously applied to the LEDs, It may cause migration resulting in LED damage.

EVERLIGHT ELECTRONICS CO., LTD.
Office: No 6-8, Zhonghua Rd., Shulin Dist.,
New Taipei City 23860, Taiwan, R.O.C

Tel: 886-2-2685-6688
Fax: 886-2-2685-6699
<http://www.everlight.com>

DISCLAIMER

1. EVERLIGHT reserves the right(s) on the adjustment of product material mix for the specification.
2. The product meets EVERLIGHT published specification for a period of twelve (12) months from date of shipment.
3. The graphs shown in this datasheet are representing typical data only and do not show guaranteed values.
4. When using this product, please observe the absolute maximum ratings and the instructions for using outlined in these specification sheets. EVERLIGHT assumes no responsibility for any damage resulting from the use of the product which does not comply with the absolute maximum ratings and the instructions included in these specification sheets.
5. These specification sheets include materials protected under copyright of EVERLIGHT. Reproduction in any form is prohibited without obtaining EVERLIGHT's prior consent.
6. This product is not intended to be used for military, aircraft, automotive, medical, life sustaining or life saving applications or any other application which can result in human injury or death. Please contact authorized Everlight sales agent for special application request.

EVERLIGHT