

EAPDLP04SCAA2

Features

- Fast response times
- High photo sensitivity
- Small junction capacitance
- Pb free
- The product itself will remain within RoHS compliant version.
- Compliance with EU REACH



Descriptions

EAPDLP04SCAA2 is a high speed and sensitive PIN photodiode in a cylindrical side view plastic package. The epoxy package itself is an IR filter, spectrally matched to IR emitter.

Applications

- High speed photo detector
- Camera
- Optoelectronic switch
- VCRs, Video camera

Device Selection Guide

LED Part No.	Chip	Lens Color
	Material	
EAPDLP04SCAA2	Silicon	Black

Absolute Maximum Ratings (Ta=25°C)

Parameter	Symbol	Rating	Units
Reverse Voltage	V _R	32	V
Power Dissipation	P _d	150	mW
Lead Soldering Temperature	T _{sol}	260	°C
Operating Temperature	T _{opr}	-40 ~ +85	°C
Storage Temperature	T _{stg}	-40 ~ +100	°C

Notes: *1:Soldering time ≤ 5 seconds.

Electro-Optical Characteristics (Ta=25°C)

Parameter	Symbol	Condition	Min.	Typ.	Max.	Units
Rang of Spectral Bandwidth	$\lambda_{0.5}$	-----	840	---	1100	nm
Wavelength of Peak Sensitivity	λ_p	-----	---	940	---	nm
Open-Circuit Voltage	V _{OC}	Ee=5m W/cm ² $\lambda_p=940\text{nm}$	---	0.41	---	V
Short- Circuit Current	I _{SC}	Ee=1m W/cm ² $\lambda_p=940\text{nm}$	---	18	---	μA
Reverse Light Current	I _L	Ee=1m W/cm ² $\lambda_p=940\text{nm}$ V _R =5V	10.2	18	---	
Dark Current	I _d	Ee=0m W/cm ² V _R =10V	---	5	30	nA
Reverse Breakdown	BV _R	Ee=0m W/cm ² I _R =100 μA	32	170	---	V
Total Capacitance	C _t	Ee=0m W/cm ² V _R =5V f=1MHZ	---	18	---	pF
Rise/Fall Time	t _r /t _f	V _R =10V R _L =1K Ω	---	50/50	---	nS

Note:

- Tolerance of Luminous Intensity: ±10%
- Tolerance of Dominant Wavelength: ±1nm
- Tolerance of Forward Voltage: ±0.1V

Typical Electro-Optical Characteristics Curves

Fig.1 Power Dissipation vs. Ambient Temperature

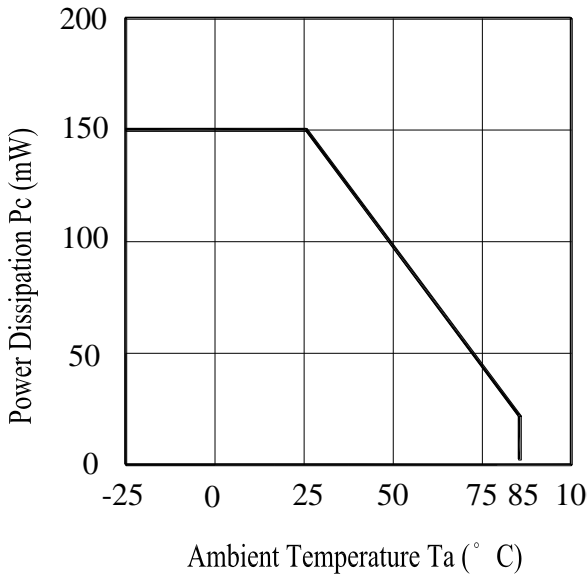

Fig.2 Spectral Sensitivity

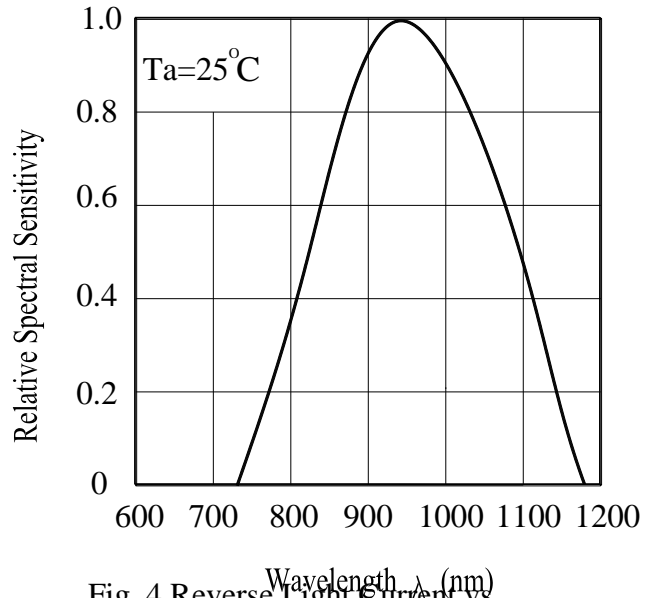

Fig.3 Dark Current vs. Ambient Temperature

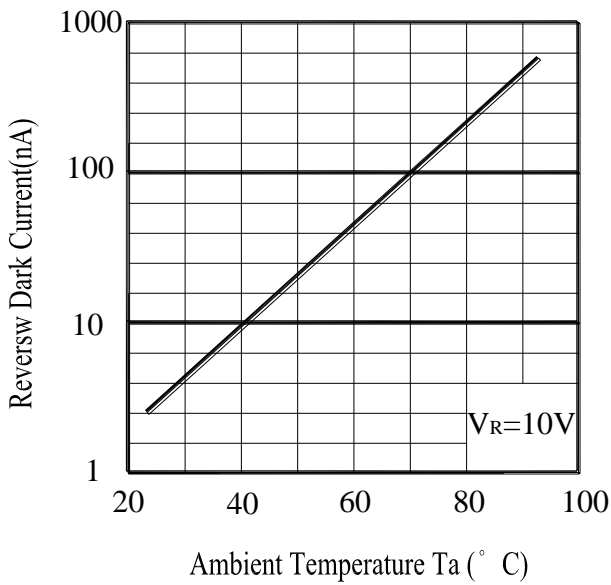
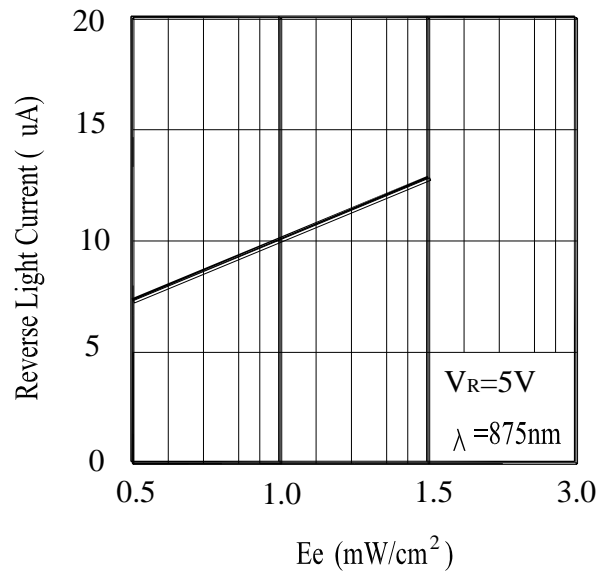

Fig. 4 Reverse Light Current vs. Ee



Typical Electro-Optical Characteristics Curves

Fig.5 Terminal Capacitance vs.

Reverse Voltage

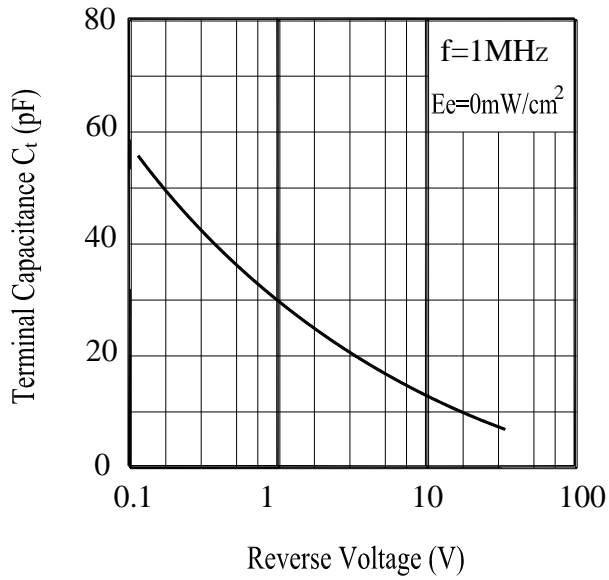
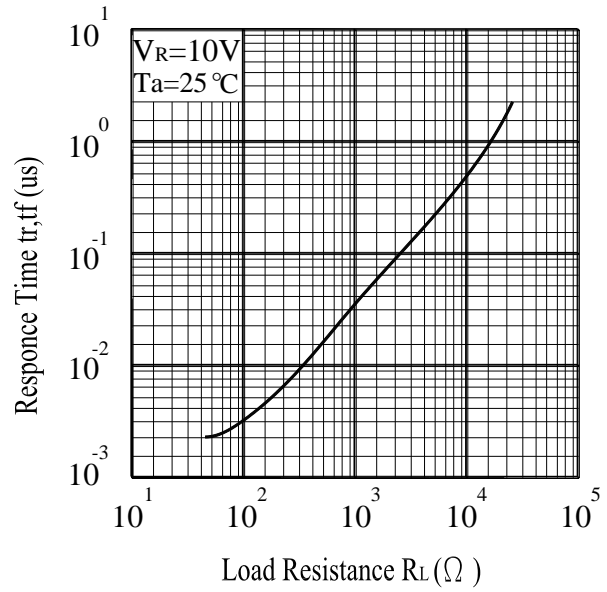
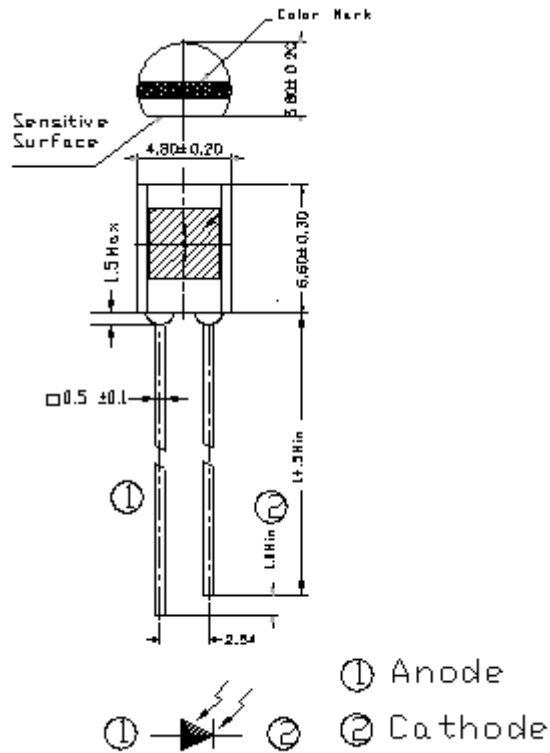

Fig.6 Response Time vs.

Load Resistance



Package Dimension



Note: Tolerances unless dimensions ± 0.25 mm

Packing Specification

- Packing Quantity
 1. 200~500 PCS/1 Bag, 5Bags/1 Inner Carton
 2. 10Inner Cartons/1 Outside Carton

Label Form Specification

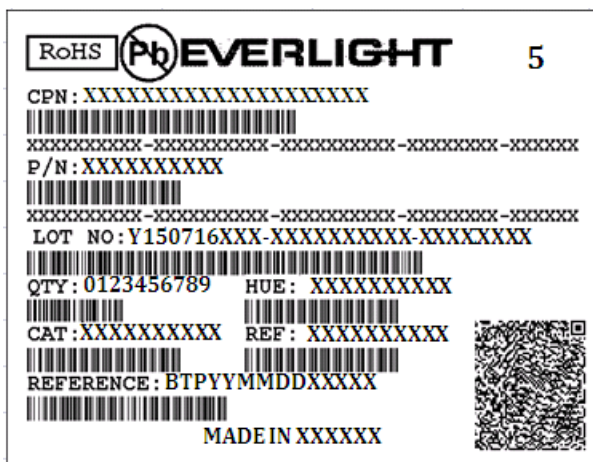

- CPN: Customer's Product Number
- P/N: Product Number
- QTY: Packing Quantity
- CAT: Luminous Intensity Rank
- HUE: Dom. Wavelength Rank
- REF: Forward Voltage Rank
- LOT No: Lot Number
- Reference: Identify Label Number

DISCLAIMER

1. EVERLIGHT reserves the right(s) on the adjustment of product material mix for the specification.
2. The product meets EVERLIGHT published specification for a period of twelve (12) months from date of shipment.
3. The graphs shown in this datasheet are representing typical data only and do not show guaranteed values.
4. When using this product, please observe the absolute maximum ratings and the instructions for using outlined in these specification sheets. EVERLIGHT assumes no responsibility for any damage resulting from the use of the product which does not comply with the absolute maximum ratings and the instructions included in these specification sheets.
5. These specification sheets include materials protected under copyright of EVERLIGHT. Reproduction in any form is prohibited without obtaining EVERLIGHT's prior consent.
6. This product is not intended to be used for military, aircraft, automotive, medical, life sustaining or life saving applications or any other application which can result in human injury or death. Please contact authorized Everlight sales agent for special application request.