

ITR20002

Features

- .Fast response time
- .High analytic
- .Cut-off visible wavelength $\lambda_p=840\text{nm}$
- .High sensitivity
- .Pb free
- .This product itself will remain within RoHS compliant version
 - Compliance with EU REACH
 - Compliance Halogen Free.(Br < 900ppm,Cl < 900ppm, Br+ Cl < 1500ppm)

Description

.The ITR20002 consist of an infrared emitting diode and an NPN silicon phototransistor, encased side-by-side on converging optical axis in a black thermoplastic housing. The phototransistor receives radiation from the IR only . This is the normal situation. But when an object is in between . phototransistor could not receive radiation

Applications

- .Mouse Copier
- .Floppy disk driver
- .Non-contact Switching
- .For Direct PC Board

Device Selection Guide

Device No.	Chip Materials	Lens Color
IR	GaAlAs	Water clear
PT	Silicon	Water clear

Absolute Maximum Ratings (Ta=25°C)

Parameter		Symbol	Ratings	Unit
Input	Power Dissipation at(or below) 25°C Free Air Temperature	Pd	100	mW
	Reverse Voltage	V _R	5	V
	Forward Current	I _F	60	mA
	Peak Forward Current (*1) Pulse width ≤ 100μs, Duty cycle=1%	I _{FP}	1	A
Output	Collector Power Dissipation	P _C	80	mW
	Collector Current	I _C	20	mA
	Collector-Emitter Voltage	B V _{CEO}	35	V
	Emitter-Collector Voltage	B V _{ECO}	6	V
Operating Temperature		T _{opr}	-25~+85	°C
Storage Temperature		T _{stg}	-40~+85	°C
Lead Soldering Temperature (*2) (1/16 inch form body for 5 seconds)		T _{sol}	260	°C

(*1) $t_w=100 \mu\text{sec.}$, $T=10 \text{ msec.}$ (*2) $t=5 \text{ Sec}$

Electro-Optical Characteristics (Ta=25°C)

Parameter		Symbol	Min.	Typ.	Max.	Unit	Conditions
Input	Forward Voltage	V_F		1.2	1.5	V	$I_F=20\text{mA}$
	Reverse Current	I_R	---	---	10	μA	$V_R=5\text{V}$
	Peak Wavelength	λ_P	---	940	---	nm	$I_F=20\text{mA}$
Output	Dark C urrent	I_{CEO}	---	---	100	nA	$V_{CE}=20\text{V}, E_e=0\text{mW}/\text{cm}^2$
	C-E Saturation Voltage	$V_{CE}(\text{sat})$	---	---	0.4	V	$I_C=0.04\text{mA}$ $I_F=40\text{mA}$
Transfer Characteristics	Collect Current	$I_C(\text{ON})$	0.04	---	0.9	mA	$V_{CE}=5\text{V}$ $I_F=20\text{mA}$
	Rise time	t_r	---	20	---	μsec	$V_{CE}=2\text{V}, I_C=100\mu\text{A}$ $, R_L=100\Omega$
	Fall time	t_f	---	25	---	μsec	

$I_C(\text{on})$ at the testing condition—with reflector in 5mm away

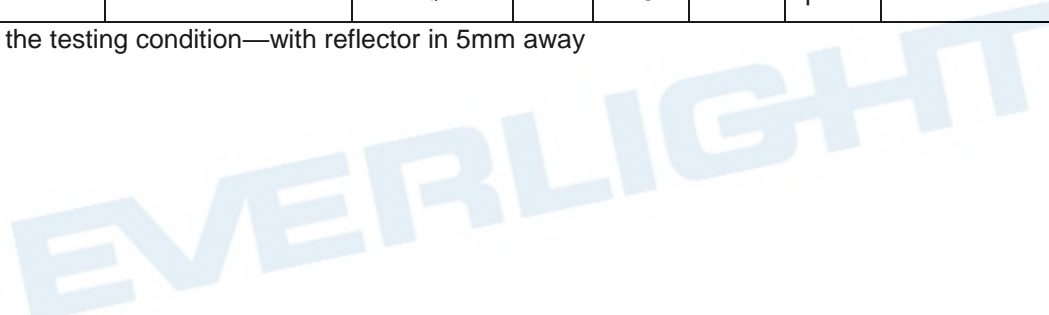

Typical Electrical/Optical/Characteristics Curves for IR

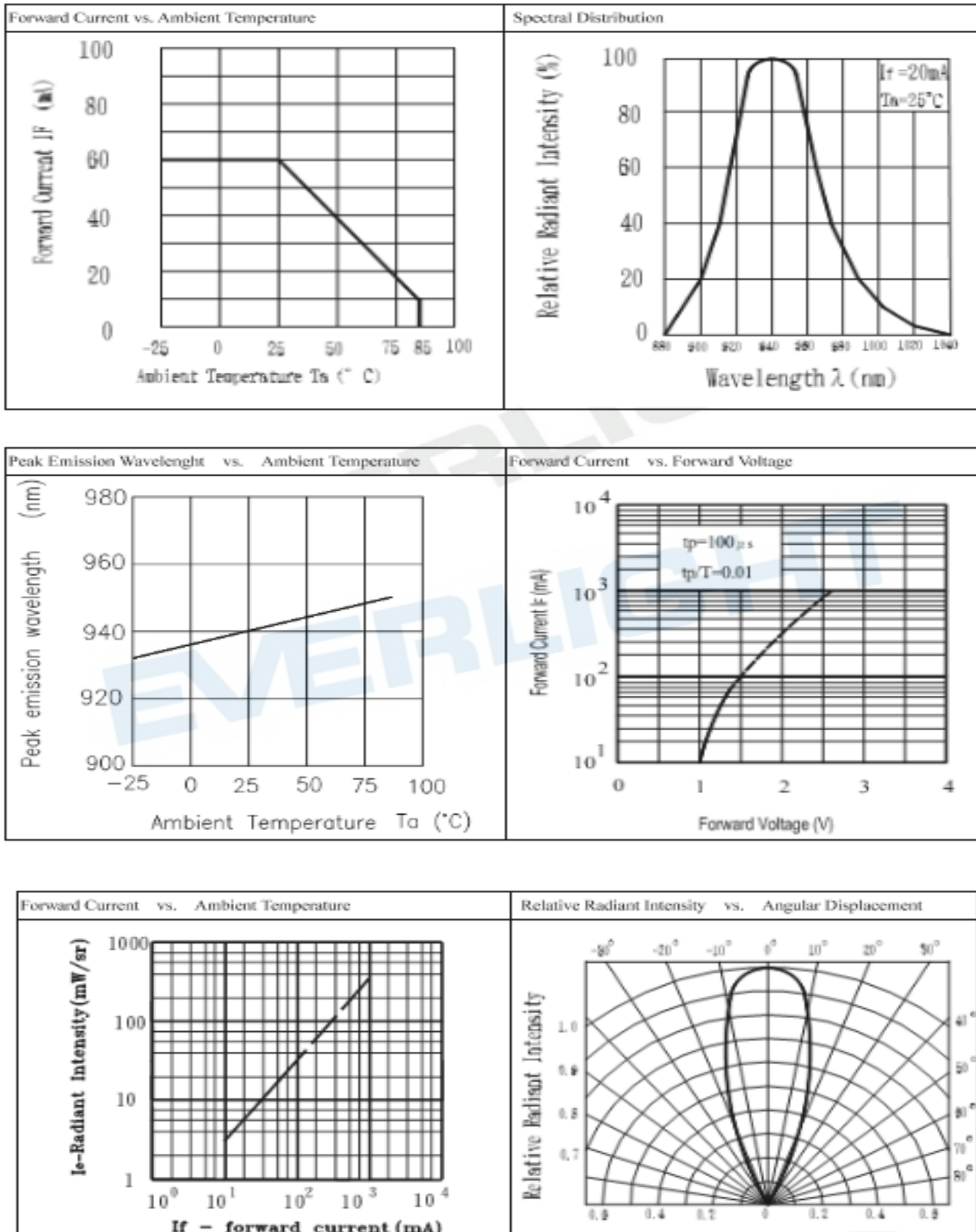

Typical Electrical/Optical/Characteristics Curves for PT

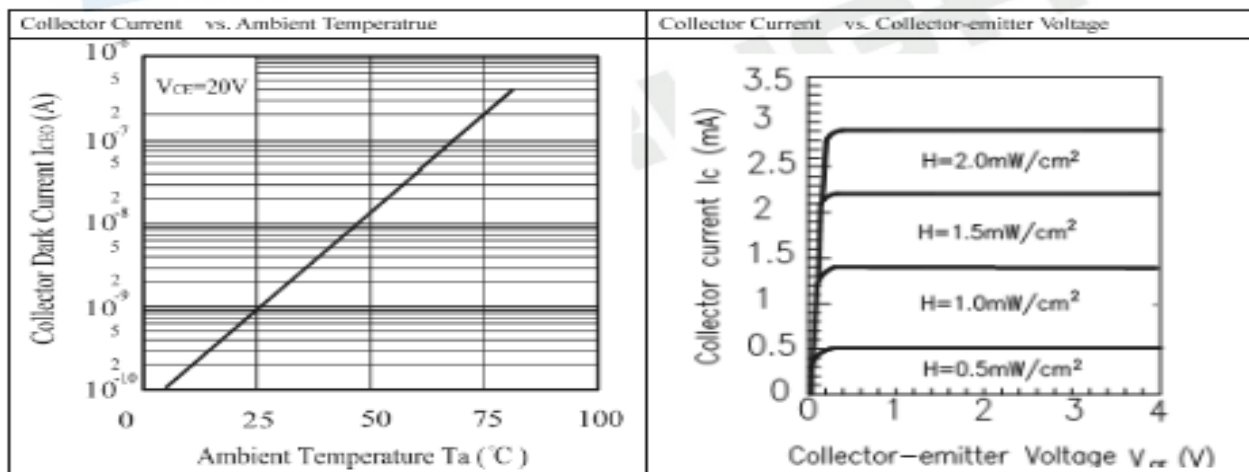
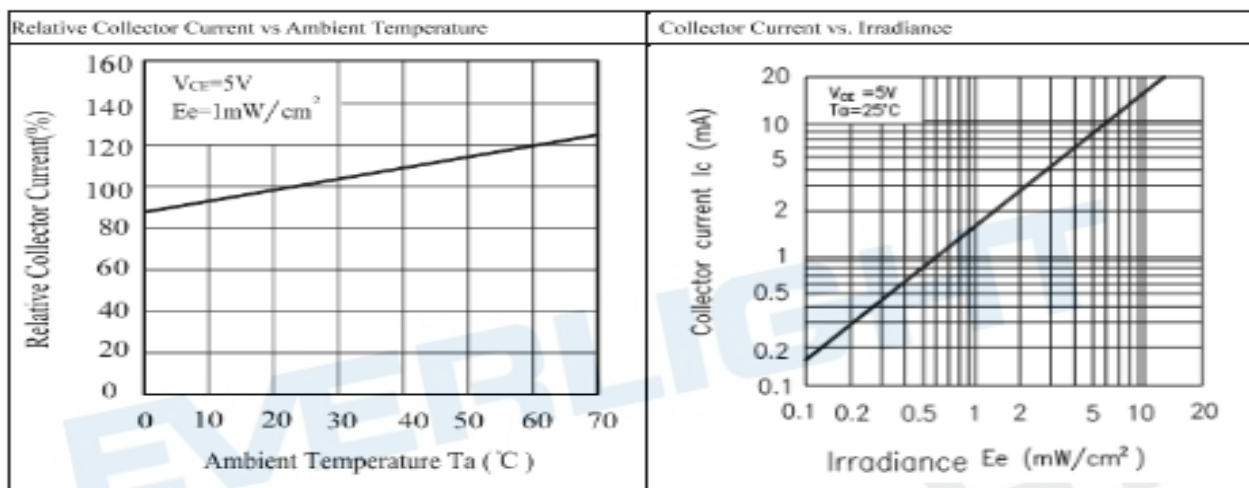
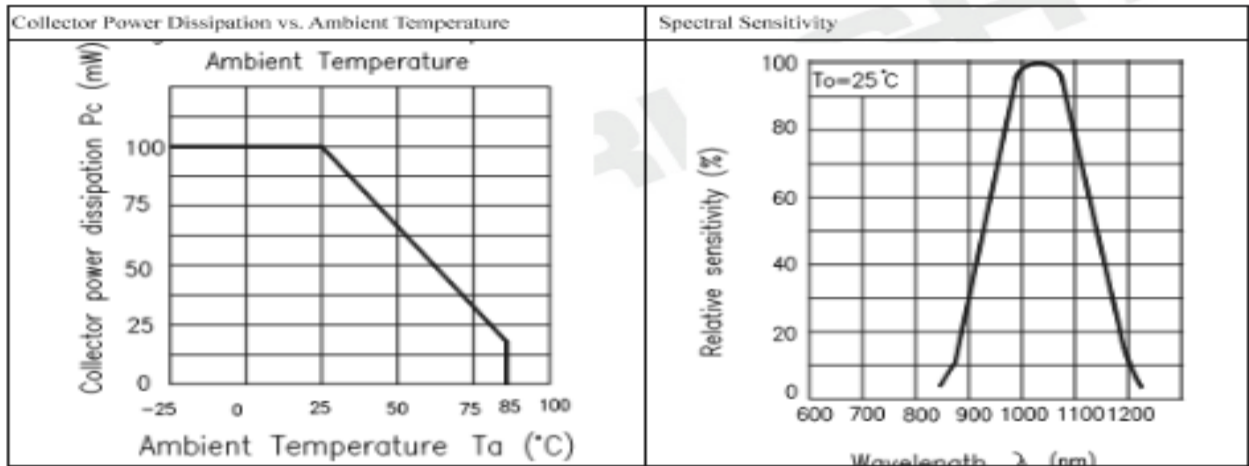

Package Dimension

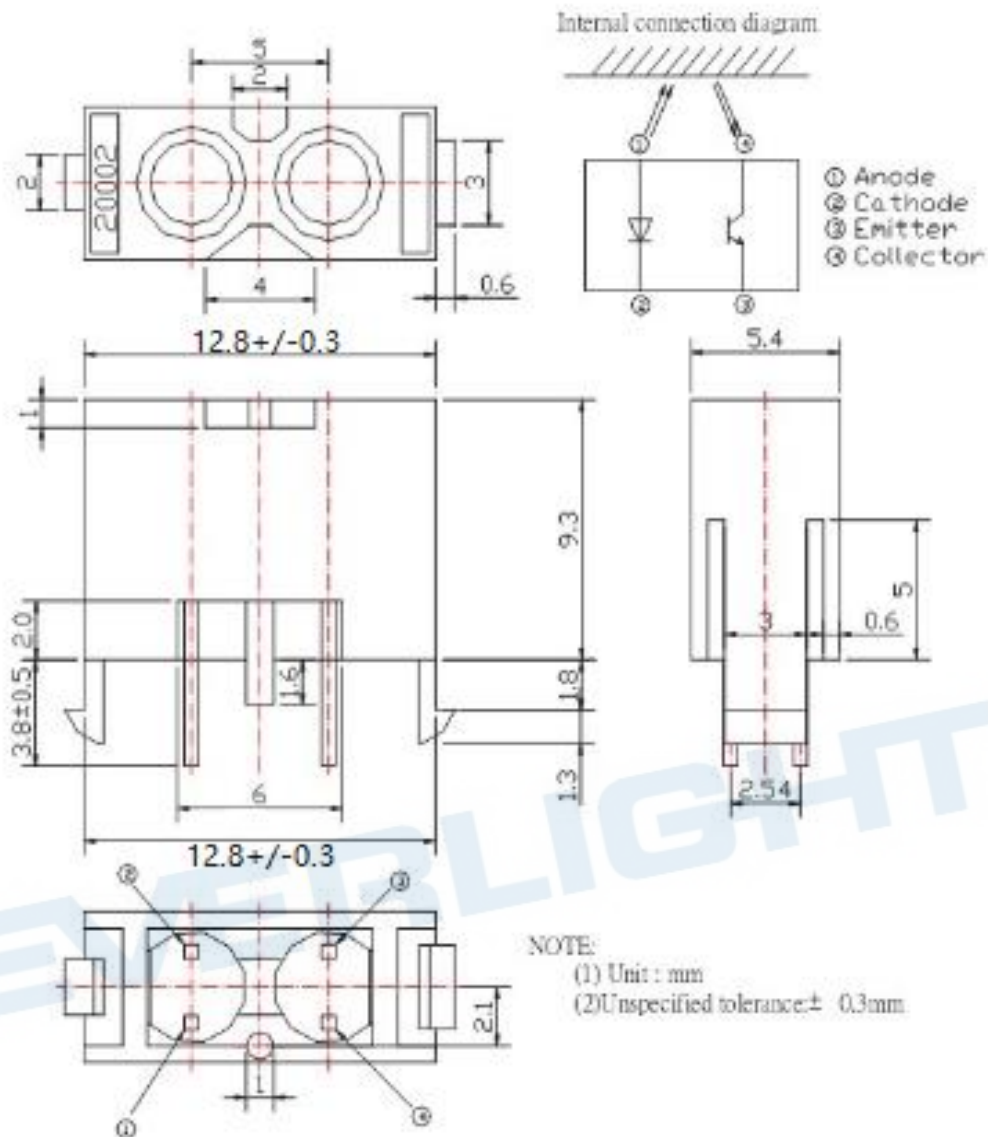

Note: Tolerances unless dimensions ±0.25mm

Label Form Specification

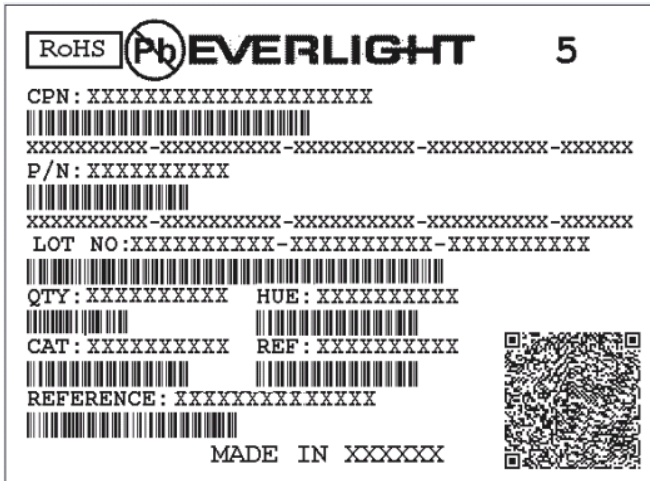

- CPN: Customer's Product Number
- P/N: Product Number
- QTY: Packing Quantity
- CAT: Luminous Intensity Rank
- HUE: Dom. Wavelength Rank
- REF: Forward Voltage Rank
- LOT No: Lot Number
- X: Month
- Reference: Identify Label Number

Packing Quantity Specification

- 1.150PCS/1Bag,5Bags/1Box
- 2.10Boxes/1Carton

DISCLAIMER

1. EVERLIGHT reserves the right(s) on the adjustment of product material mix for the specification.
2. The product meets EVERLIGHT published specification for a period of twelve (12) months from date of shipment.
3. The graphs shown in this datasheet are representing typical data only and do not show guaranteed values.
4. When using this product, please observe the absolute maximum ratings and the instructions for using outlined in these specification sheets. EVERLIGHT assumes no responsibility for any damage resulting from the use of the product which does not comply with the absolute maximum ratings and the instructions included in these specification sheets.
5. These specification sheets include materials protected under copyright of EVERLIGHT. Reproduction in any form is prohibited without obtaining EVERLIGHT's prior consent.
6. This product is not intended to be used for military, aircraft, automotive, medical, life sustaining or life saving applications or any other application which can result in human injury or death. Please contact authorized Everlight sales agent for special application request.