

Shwo 1W Series

爍

“Shwo [Shuo] is the English translation for the Chinese word meaning Twinkle and is often used as a description of stars or other bright, celestial objects as seen from Earth. This word is a relevant description for this bright, compact Everlight LED package.”

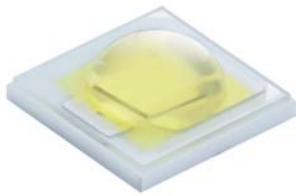

Introduction

The Shwo series is a surface-mount high-power device featuring high brightness combined with a compact size that is suitable for all kinds of lighting applications such as general illumination, flash, spot, signal, industrial and commercial lighting. The thermal pad of this device is electrically isolated providing convenience in thermal and electrical design. The Shwo series is one of the most promising devices in Everlight's high power product offering and is ready to face the challenges of today's Solid-State Lighting requirements.

Features

- ◆ LM-80 Certified
- ◆ Small package with high efficiency
- ◆ ESD protection up to 8KV
- ◆ Soldering method: SMT
- ◆ Binning Parameters: Brightness, Forward Voltage ,Wavelength and Chromaticity
- ◆ Moisture Sensitivity Level: 1
- ◆ RoHS compliant
- ◆ Matches ANSI binning
- ◆ Compliance with EU REACH
- ◆ Compliance Halogen Free .
(Br<900ppm,Cl<900ppm,Br+Cl<1500ppm)

Applications

- ◆ General Lighting
- ◆ Decorative and Entertainment Lighting
- ◆ Signal and Symbol Luminaries for orientation marker lights (e.g. steps, exit ways, etc.)
- ◆ Exterior and Interior Automotive Illumination
- ◆ Agriculture Lighting

Product Nomenclature

The product name is designated as below:

ELSW – ABCDE – FGHIJ – V1234

Designation:

AB = min. luminous flux (lm) or radiation power (mW) performance

C = radiation pattern [1]

D = color [2]

E = power consumption [3]

F = reserved for future product offerings

G = Internal code

H = packaging type [4]

IJ = internal code

V = forward voltage bin

1234 = color bin or CCT bin

Notes

1. Table of radiation patterns

| Symbol | Description |
|--------|-------------|
| 1 | Lambertian |

2. Table of color offerings:

| Symbol | Color | Dominant wavelength range |
|--------|---------------|---------------------------|
| R | Red | 620~630nm |
| O | Orange | 610~620nm |
| Y | Amber | 585~595nm |
| A | Cyan | 490~520nm |
| G | Green | 520~535nm |
| B | Blue | 460~485nm |
| C | Cool-White | 4745~7050K |
| L | Royal-Blue | 445~460nm |
| N | Neutral-White | 3710~4745K |
| M | Warm-White | 2580~3710K |
| E | Deep-Red | 645~675nm |

3. Table of power consumptions:

| Symbol | Description |
|--------|-------------|
| 1 | 1W |

4. Table of packaging types:

| Symbol | Description |
|--------|-------------|
| P | Tape |

Absolute Maximum Ratings

| Parameter | Symbol | Ratings | Unit |
|------------------------------|-------------|---------------------------|--------|
| Max. DC Forward Current (mA) | I_F | 700 ^[1] | mA |
| Max. Peak Pulse Current (mA) | I_{Pulse} | 1000 ^[2] | mA |
| Max. ESD Resistance | V_B | 8000 | V |
| Reverse Voltage | V_R | Note 3 | V |
| Thermal Resistance | R_{th} | 10 ~ 12 ^[4] | °C/W |
| Max. Junction Temperature | T_J | 125 ^[5] | °C |
| Operating Temperature | T_{Opr} | -40 ~ +100 ^[6] | °C |
| Storage Temperature | T_{Stg} | -40 ~ +100 | °C |
| Max. Soldering Temperature | T_{sol} | 260 | °C |
| Max. Allowable Reflow Cycles | n/a | 2 | cycles |

Notes:

- Maximum forward current for 1W is 700mA (Thermal Pad=25°C).
- Maximum peak pulse current for 1W is 1000mA (Duty cycle = 1/10@1KHZ)
- The Shwo series LEDs are not designed for reverse bias use.
- Thermal Resistance is 10°C/W for Blue, Green, Cool-White, Neutral-White, and Warm-White LEDs and 12°C/W for Red, Amber, and Orange LEDs.
- Maximum junction temperature of Cool-White, Neutral-White, Warm-White, Blue, Green, Red, Amber, and Orange LEDs is 125°C.
- Maximum Operating Temperature (Thermal Pad) of Cool-White, Neutral-White, Warm-White, Blue, Green, Red, Amber, and Orange LEDs is 100°C.

JEDEC Moisture Sensitivity

| Level | Floor Life | | Soak Requirements Standard | |
|-------|--------------|---|----------------------------|---------------|
| | Time (hours) | Conditions | Time (hours) | Conditions |
| 1 | Unlimited | $\leq 30^\circ\text{C} / 85\% \text{ RH}$ | 168 (+5/-0) | 85°C / 85% RH |

Luminous Flux Characteristics for the Shwo series

| Color | Part Number | 1W | |
|------------|--------------|---|-----------------------|
| | | Minimum Luminous Flux(lm) or Radiometric Power(mW) _[1] | Drive Current (mA) |
| Red | ELSW – F51RX | 52 | 350 |
| | ELSW – F61RX | 60 | 350 |
| Orange | ELSW– F51OX | 52 | 350 |
| | ELSW– F61OX | 60 | 350 |
| Amber | ELSW– F41YX | 45 | 350 |
| | ELSW– F51YX | 52 | 350 |
| Green | ELSW– F71GX | 70 | 350 |
| | ELSW– F81GX | 80 | 350 |
| | ELSW– F91GX | 90 | 350 |
| Blue | ELSW– E71BX | 17 | 350 |
| | ELSW– E81BX | 20 | 350 |
| | ELSW– E91BX | 23 | 350 |
| | ELSW– F11BX | 27 | 350 |
| | ELSW– F21BX | 33 | 350 |
| Royal Blue | ELSW – Q91LX | 275 | 350 |
| | ELSW – R31LX | 430 | 350 |
| | ELSW – R51LX | 530 | 350 |
| Deep Red | ELSW – Q91EX | 275 | 350 |
| | ELSW – R11EX | 330 | 350 |
| | ELSW – R21EX | 380 | 350 |
| | ELSW – RA1EX | 420 | 350 |
| Far Red | ELSW – Q61FX | 175 | 350 |
| | ELSW – Q81FX | 225 | 350 |

Notes:

1. Luminous flux measurement tolerance: $\pm 10\%$.
2. The data of luminous flux measured at thermal pad=25°C
3. Typical luminous flux or light output performance is operated within the condition guided by this datasheet.

PN of the Shwo series: White LEDs

The table below is a list of part numbers for the Everlight Shwo 1W series White LED. All parts listed match ANSI binning standards. Bin offerings of 2700K to 6500K are listed and currently available. CRI is also listed with min 70 to 80. Typical view angle is 120°. These clearly listed binning options allow for proper design and implementation into lighting applications. The Order Codes below are currently available White Shwo LEDs.

For Example: If you order product using P/N **ELSW-F91C1-0LPGS-C5700**, you will be specifying:

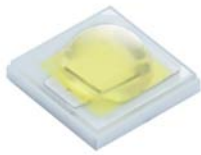

| Color | Radiation Pattern | CRI | CCT | Forward Voltage (V) | Minimum Luminous Flux (lm) |
|------------|-------------------|-----|-------------------------------------|---|----------------------------|
| Cool White | Lambertian | 70 | 57K-1 ~ 57K-2 ~ 57K-3 ~ 57K-4 | 2.65~2.95(U4) 2.95~3.25(V1) 3.25~3.55(V2) | 90 |

White, Shwo series LEDs at 350mA are listed below

| Color | Order Code of ELSW | Minimum Luminous Flux (lm) | CCT (K) Wavelength (nm) | Forward Voltage (V) | CRI (min) |
|--------------------|------------------------|----------------------------|-------------------------|---------------------|-----------|
| Cool White 6500 | ELSW-J21C1-0LPGS-C6500 | 110 | 65K-1~65K-4 | 2.65~3.55 | 70 |
| Cool White 5700 | ELSW-J21C1-0LPGS-C5700 | 110 | 57K-1~57K-4 | 2.65~3.55 | 70 |
| Cool White 5000 | ELSW-F91C1-0LPGS-C5000 | 90 | 50K-1~50K-4 | 2.65~3.55 | 70 |
| Neutral White 4500 | ELSW-F81N1-0LPGS-C4500 | 80 | 45K-1~45K-4 | 2.65~3.55 | 75 |
| Neutral White 4000 | ELSW-F81N1-0LPGS-C4000 | 80 | 40K-1~40K-4 | 2.65~3.55 | 75 |
| Warm White 3500 | ELSW-F71M1-0LPGS-C3500 | 70 | 35K-1~35K-4 | 2.65~3.55 | 75 |
| Warm White 3000 | ELSW-F71M1-0LPGS-C3000 | 70 | 30K-1~30K-4 | 2.65~3.55 | 75 |
| Warm White 2700 | ELSW-F61M1-0LPGS-C2700 | 60 | 27K-1~27K-4 | 2.65~3.55 | 75 |

Notes:

1. CRI measurement tolerance: ± 2 .
2. Each 1W white PN is based on the min. bin, and includes two adjacent bins

PN of the Shwo High Luminous Series: White LEDs

The table below is a list of part numbers for the Everlight Shwo 1W high luminous series White LED. All parts listed match ANSI binning standards. Bin offerings of 2700K to 6500K are listed and currently available. CRI is also listed with min 70 to 80. Typical view angle is 100°. These clearly listed binning options allow for proper design and implementation into lighting applications. The Order Codes below are currently available White Shwo LEDs.

For Example: If you order product using P/N **ELSW-J11C1-0CPGS-C5700**, you will be specifying:

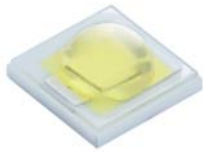

| Color Variant | Radiation Pattern | CRI | CCT | Forward Voltage (V) | Minimum Luminous Flux (lm) |
|---------------|-------------------|-----|-------------------------------------|---|----------------------------|
| Cool White | Lambertian | 70 | 57K-1 ~ 57K-2 ~ 57K-3 ~ 57K-4 | 2.65~2.95(U4) 2.95~3.25(V1) 3.25~3.55(V2) | 100 |

White Shwo series LEDs at 350mA are listed below.

| Color | Order Code of ELSW | Minimum Luminous Flux (lm) | CCT (K) Wavelength (nm) | Forward Voltage (V) | CRI (min) |
|--------------------|------------------------|----------------------------|-------------------------|---------------------|-----------|
| Cool White 6500 | ELSW-F91C1-0CPGS-C6500 | 90 | 65K-1~65K-4 | 2.65~3.55 | 70 |
| | ELSW-J11C1-0CPGS-C6500 | 100 | 65K-1~65K-4 | 2.65~3.55 | 70 |
| | ELSW-J21C1-0VPGS-C6500 | 110 | 65K-1~65K-4 | 2.65~3.55 | 70 |
| | ELSW-J31C1-0VPGS-C6500 | 120 | 65K-1~65K-4 | 2.65~3.55 | 70 |
| | ELSW-J11C1-0VPHS-C6500 | 100 | 65K-1~65K-4 | 2.65~3.55 | 80 |
| Cool White 5700 | ELSW-F91C1-0CPGS-C5700 | 90 | 57K-1~57K-4 | 2.65~3.55 | 70 |
| | ELSW-J11C1-0CPGS-C5700 | 100 | 57K-1~57K-4 | 2.65~3.55 | 70 |
| | ELSW-J21C1-0VPGS-C5700 | 110 | 57K-1~57K-4 | 2.65~3.55 | 70 |
| | ELSW-J31C1-0VPGS-C5700 | 120 | 57K-1~57K-4 | 2.65~3.55 | 70 |
| | ELSW-J11C1-0VPHS-C5700 | 100 | 57K-1~57K-4 | 2.65~3.55 | 80 |
| Cool White 5000 | ELSW-F91C1-0CPGS-C5000 | 90 | 50K-1~50K-4 | 2.65~3.55 | 70 |
| | ELSW-J11C1-0VPGS-C5000 | 100 | 50K-1~50K-4 | 2.65~3.55 | 70 |
| | ELSW-J21C1-0CPGS-C5000 | 110 | 50K-1~50K-4 | 2.65~3.55 | 70 |
| | ELSW-J31C1-0CPGS-C5000 | 120 | 50K-1~50K-4 | 2.65~3.55 | 70 |
| | ELSW-F91C1-0CPHS-C5000 | 90 | 50K-1~50K-4 | 2.65~3.55 | 80 |
| Neutral White 4500 | ELSW-F91N1-0CPGS-C4500 | 90 | 45K-1~45K-4 | 2.65~3.55 | 75 |
| | ELSW-J11N1-0VPGS-C4500 | 100 | 45K-1~45K-4 | 2.65~3.55 | 75 |
| Neutral White 4000 | ELSW-F91N1-0CPGS-C4000 | 90 | 40K-1~40K-4 | 2.65~3.55 | 75 |
| | ELSW-J11N1-0VPGS-C4000 | 100 | 40K-1~40K-4 | 2.65~3.55 | 75 |
| | ELSW-F81N1-0VPHS-C4000 | 80 | 40K-1~40K-4 | 2.65~3.55 | 80 |

| | ELSW-F91N1-0CPHS-C4000 | 90 | 40K-1~40K-4 | 2.65~3.55 | 80 |
|-----------------|------------------------|----------------------------|-------------------------|---------------------|-----------|
| Color | Order Code of ELSW | Minimum Luminous Flux (lm) | CCT (K) Wavelength (nm) | Forward Voltage (V) | CRI (min) |
| Warm White 3500 | ELSW-F81M1-0CPGS-C3500 | 80 | 35K-1~35K-4 | 2.65~3.55 | 75 |
| | ELSW-F91M1-0VPGS-C3500 | 90 | 35K-1~35K-4 | 2.65~3.55 | 75 |
| | ELSW-F71M1-0CPHS-C3500 | 70 | 35K-1~35K-4 | 2.65~3.55 | 80 |
| Warm White 3000 | ELSW-F81M1-0CPGS-C3000 | 80 | 30K-1~30K-4 | 2.65~3.55 | 75 |
| | ELSW-F91M1-0VPGS-C3000 | 90 | 30K-1~30K-4 | 2.65~3.55 | 75 |
| | ELSW-F71M1-0CPHS-C3000 | 70 | 30K-1~30K-4 | 2.65~3.55 | 80 |
| | ELSW-F81M1-0VPHS-C3000 | 80 | 30K-1~30K-4 | 2.65~3.55 | 80 |
| | ELSW-F91M1-0VPHS-C3000 | 90 | 30K-1~30K-4 | 2.65~3.55 | 80 |
| Warm White 2700 | ELSW-F71M1-0CPGS-C2700 | 70 | 27K-1~27K-4 | 2.65~3.55 | 75 |
| | ELSW-F81M1-0CPGS-C2700 | 80 | 27K-1~27K-4 | 2.65~3.55 | 75 |
| | ELSW-F91M1-0VPGS-C2700 | 90 | 27K-1~27K-4 | 2.65~3.55 | 75 |
| | ELSW-F61M1-0CPHS-C2700 | 60 | 27K-1~27K-4 | 2.65~3.55 | 80 |
| | ELSW-F71M1-0CPHS-C2700 | 70 | 27K-1~27K-4 | 2.65~3.55 | 80 |
| | ELSW-F81M1-0VPHS-C2700 | 80 | 27K-1~27K-4 | 2.65~3.55 | 80 |
| | ELSW-F91M1-0VPHS-C2700 | 90 | 27K-1~27K-4 | 2.65~3.55 | 80 |

Notes:

1. CRI measurement tolerance: ± 2 .
2. Each 1W white PN is based on the min. bin, and includes two adjacent bins

PN of the Shwo series: Color LEDs

The table below is a list of the binning options for the Everlight Shwo 1W series Color LED. Standard Everlight color bins are listed according to wavelength and represent the standard primary colors of the spectrum. Typical view angle is 120°. These clearly listed binning options allow for proper design and implementation into lighting applications. The Order Codes below are currently available Color Shwo LEDs. For Example: If you order product using P/N **ELSW-F61R1-0LPNM-AR5R6**, you will be specifying:



| Color Variant | Radiation Pattern | Dominant Wavelength (nm) | Forward Voltage (V) | Minimum Luminous Flux (lm) |
|---------------|-------------------|----------------------------|--|----------------------------|
| Red | Lambertian | 620~625(R5) 625~630(R6) | 1.75~2.05(U1) 2.05~2.35(U2) 2.35~2.65(U3) 2.65~2.95(U4) | 60 |

Color, Shwo series LEDs at 350mA are listed below.

| Color | Order Code of ELSW | Minimum Luminous Flux (lm) | Wavelength (nm) | Forward Voltage(V) |
|--------|---------------------------------|----------------------------|-----------------|--------------------|
| Red | ELSW-F51R1-0LPNM-AR5R6 | 52 | 620~630 | 1.75~2.95 |
| | ELSW-F61R1-0LPNM-AR5R6 | 60 | 620~630 | 1.75~2.95 |
| | ELSW-F61R1-0PPNM-AR5R6 | 60 | 620~630 | 1.75~2.95 |
| Orange | ELSW-F51O1-0LPNM-AR3R4 | 52 | 610~620 | 1.75~2.95 |
| | ELSW-F61O1-0LPNM-AR3R4 | 60 | 610~620 | 1.75~2.95 |
| Amber | ELSW-F41Y1-0LPNM-AA3A5 | 45 | 585~592.5 | 1.75~2.95 |
| | ELSW-F51Y1-0LPNM-AA3A5 | 52 | 585~592.5 | 1.75~2.95 |
| Green | GELSW-FB1A1-0LPNM-CC1C4/ | 75 | 490-510 | 2.65~3.85 |
| | ELSW-F71G1-0LPNM-CG1G2 | 70 | 520~530 | 2.65~3.85 |
| | ELSW-F71G1-0LPNM-CG2G3 | 70 | 525~535 | 2.65~3.85 |
| | ELSW-F81G1-0GPNM-CG1G2 | 80 | 520~530 | 2.65~3.85 |
| | ELSW-F91G1-0LPNM-CG1G2 | 90 | 520~530 | 2.65~3.85 |
| | *ELSW-J31G1-0LPNM-CG1G2 | 120 | 520~530 | 2.65~3.85 |
| | *ELSW-J31G1-0LPNM-CG2G3 | 120 | 525~535 | 2.65~3.85 |
| Blue | *ELSW-E71B1-0LPNM-CB7B8 | 17 | 460~470 | 2.65~3.85 |
| | *ELSW-E81B1-0LPNM-CB7B8 | 20 | 460~470 | 2.65~3.85 |
| | *ELSW-E91B1-0LPNM-CB7B8 | 23 | 460~470 | 2.65~3.85 |
| | *ELSW-F11B1-0LPNM-CB8B9 | 27 | 465~475 | 2.65~3.85 |
| | *ELSW-F21B1-0LPNM-CBABB | 33 | 475~485 | 2.65~3.85 |

*Product lead time of at least 8 weeks.

Notes:

- Each 1W direct color PN is based on the min. bin and includes four adjacent bins

| Color | Order Code of ELSW | Minimum Radiometric Power (mW) | Peak Wavelength (nm) | Forward Voltage(V) |
|------------|-------------------------|--------------------------------|----------------------|--------------------|
| Royal Blue | ELSW-Q91L1-0LPNM-CB4B6 | 275 | 445~460 | 2.65~3.85 |
| | ELSW-R31L1-0LPNM-CB4B6 | 430 | 445~460 | 2.65~3.85 |
| | ELSW-R41L1-0EPNM-CB4B6 | 480 | 445~460 | 2.65~3.85 |
| | ELSW-R51L1-0EPNM-CB4B6 | 530 | 445~460 | 2.65~3.85 |
| Deep Red | *ELSW-Q91E1-0LPNM-AD3D8 | 275 | 645~675 | 1.75~2.95 |
| | *ELSW-R11E1-0LPNM-AD3D8 | 330 | 645~675 | 1.75~2.95 |
| | *ELSW-R11E1-0EPNM-AD3D8 | 330 | 645~675 | 1.75~2.95 |
| | *ELSW-R21E1-0EPNM-AD3D8 | 380 | 645~675 | 1.75~2.95 |
| | *ELSW-RA1E1-0LPNM-AD3D8 | 420 | 645~675 | 1.75~2.95 |
| Far Red | *ELSW-Q61F1-0LPNM-AF3F8 | 125 | 715~745 | 1.6~2.95 |
| | *ELSW-Q81F1-0LPNM-HF3F8 | 225 | 715~745 | 1.6~2.65 |
| | *ELSW-Q81F1-0EPNM-HF3F8 | 225 | 715~745 | 1.6~2.65 |
| | *ELSW-Q91F1-0LPNM-AF3F8 | 275 | 715~745 | 1.75~2.95 |

*Product lead time of at least 8 weeks.

Note: Each 1W direct color PN is based on the min. bin and includes four adjacent bins.

Product Binning Luminous Flux Bins

| Group | Bin | Minimum Photometric Flux (lm) | Maximum Photometric Flux (lm) |
|-------|-----|-------------------------------|-------------------------------|
| E | 1 | 4 | 5 |
| | 2 | 5 | 6 |
| | 3 | 6 | 8 |
| | 4 | 8 | 10 |
| | 5 | 10 | 13 |
| | 6 | 13 | 17 |
| | 7 | 17 | 20 |
| | 8 | 20 | 23 |
| | 9 | 23 | 27 |
| F | 1 | 27 | 33 |
| | 2 | 33 | 39 |
| | 3 | 39 | 45 |
| | 4 | 45 | 52 |
| | 5 | 52 | 60 |
| | 6 | 60 | 70 |
| | 7 | 70 | 80 |
| | 8 | 80 | 90 |
| | 9 | 90 | 100 |
| | A | 65 | 75 |
| | B | 75 | 85 |
| | C | 85 | 95 |
| | E | 95 | 105 |

| Group | Bin | Minimum Photometric Flux (lm) | Maximum Photometric Flux (lm) |
|-------|-----|-------------------------------|-------------------------------|
| J | 1 | 100 | 110 |
| | 2 | 110 | 120 |
| | 3 | 120 | 130 |
| | 4 | 130 | 140 |
| | 5 | 140 | 150 |
| | 6 | 150 | 160 |
| | 7 | 160 | 170 |
| | 8 | 170 | 180 |
| | 9 | 180 | 190 |
| | 0 | 190 | 200 |
| | A | 105 | 115 |
| | B | 115 | 125 |
| | C | 125 | 135 |
| | E | 135 | 145 |
| F | 145 | 155 | |
| G | 155 | 165 | |
| H | 165 | 175 | |
| J | 175 | 185 | |
| K | 185 | 195 | |
| L | 195 | 205 | |

Radiometric Power Bins

| Group Bin | Minimum Radiometric Power(mW) | Maximum Radiometric Power(mW) |
|-----------|-------------------------------|-------------------------------|
| Q6Q7 | 125 | 225 |
| Q7Q8 | 175 | 275 |
| Q8Q9 | 225 | 330 |
| Q9R1 | 275 | 380 |
| R1R2 | 330 | 430 |
| R2R3 | 380 | 480 |
| R3R4 | 430 | 530 |
| R4R5 | 480 | 600 |
| R5R6 | 530 | 700 |
| R6 | 600 | 700 |
| R7 | 700 | 800 |
| R8 | 800 | 900 |

White Bin Structure

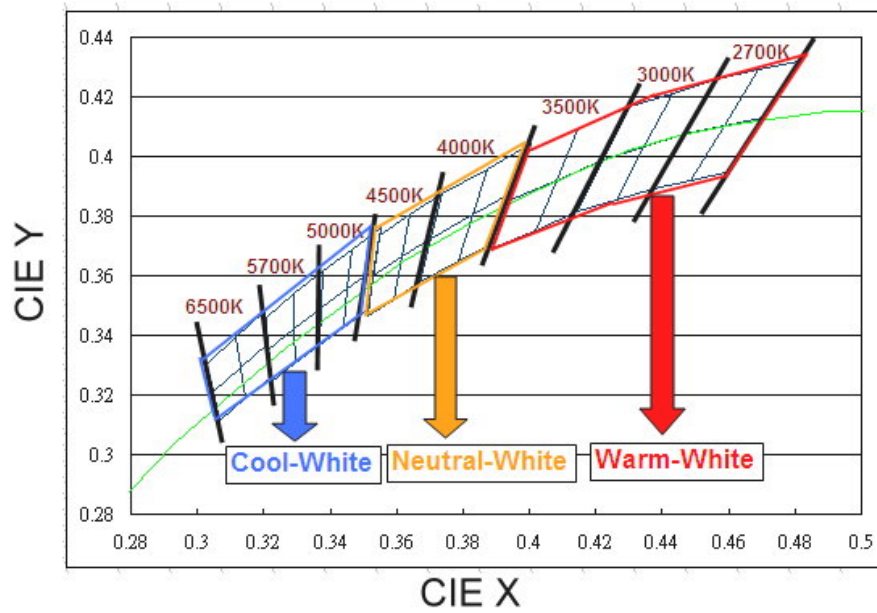

Chromaticity specification defined by ANSI

Notes:

1. The CCT range of Cool-White varies from 4745K to 7050K.
2. The CCT range of Neutral-White varies from 3710K to 4745K.
3. The CCT range of Warm-White varies from 2580K to 3710K.
4. Color coordinates measurement allowance : ± 0.01
5. Color bins are defined at $I_f=350\text{mA}$ operation.

Cool-White Bin Structure

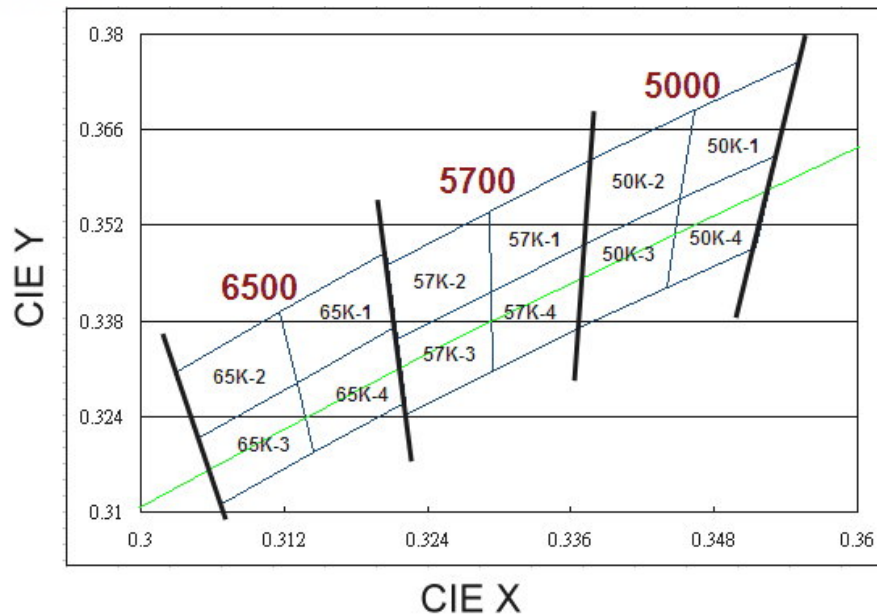

Cool-White Bin Coordinates

5000K

| Bin | CIE X | CIE Y |
|-----------------------------|-------|-------|
| 50K-1 | 0.346 | 0.369 |
| | 0.345 | 0.356 |
| | 0.353 | 0.362 |
| | 0.355 | 0.376 |
| Reference Range: 4745~5000K | | |

| Bin | CIE X | CIE Y |
|-----------------------------|-------|-------|
| 50K-2 | 0.338 | 0.362 |
| | 0.337 | 0.349 |
| | 0.345 | 0.356 |
| | 0.346 | 0.369 |
| Reference Range: 5000~5310K | | |

| Bin | CIE X | CIE Y |
|-----------------------------|-------|-------|
| 50K-4 | 0.345 | 0.356 |
| | 0.344 | 0.343 |
| | 0.352 | 0.349 |
| | 0.353 | 0.362 |
| Reference Range: 4745~5000K | | |

| Bin | CIE X | CIE Y |
|-----------------------------|-------|-------|
| 50K-3 | 0.337 | 0.349 |
| | 0.337 | 0.337 |
| | 0.344 | 0.343 |
| | 0.345 | 0.356 |
| Reference Range: 5000~5310K | | |

5700K

| Bin | CIE X | CIE Y |
|-----------------------------|-------|-------|
| 57K-1 | 0.329 | 0.354 |
| | 0.329 | 0.342 |
| | 0.337 | 0.349 |
| | 0.338 | 0.362 |
| Reference Range: 5310~5700K | | |

| Bin | CIE X | CIE Y |
|-----------------------------|-------|-------|
| 57K-2 | 0.321 | 0.346 |
| | 0.321 | 0.335 |
| | 0.329 | 0.342 |
| | 0.329 | 0.354 |
| Reference Range: 5700~6020K | | |

| Bin | CIE X | CIE Y |
|-----------------------------|-------|-------|
| 57K-4 | 0.329 | 0.342 |
| | 0.329 | 0.331 |
| | 0.337 | 0.337 |
| | 0.337 | 0.349 |
| Reference Range: 5310~5700K | | |

| Bin | CIE X | CIE Y |
|-----------------------------|-------|-------|
| 57K-3 | 0.321 | 0.335 |
| | 0.322 | 0.324 |
| | 0.329 | 0.331 |
| | 0.329 | 0.342 |
| Reference Range: 5700~6020K | | |

6500K

| Bin | CIE X | CIE Y |
|-----------------------------|-------|-------|
| 65K-1 | 0.312 | 0.339 |
| | 0.313 | 0.329 |
| | 0.321 | 0.337 |
| | 0.321 | 0.348 |
| Reference Range: 6020~6500K | | |

| Bin | CIE X | CIE Y |
|-----------------------------|-------|-------|
| 65K-2 | 0.303 | 0.330 |
| | 0.305 | 0.321 |
| | 0.313 | 0.329 |
| | 0.312 | 0.339 |
| Reference Range: 6500~7050K | | |

| Bin | CIE X | CIE Y |
|-----------------------------|-------|-------|
| 65K-4 | 0.313 | 0.329 |
| | 0.315 | 0.319 |
| | 0.322 | 0.326 |
| | 0.321 | 0.337 |
| Reference Range: 6020~6500K | | |

| Bin | CIE X | CIE Y |
|-----------------------------|-------|-------|
| 65K-3 | 0.305 | 0.321 |
| | 0.307 | 0.311 |
| | 0.315 | 0.319 |
| | 0.313 | 0.329 |
| Reference Range: 6500~7050K | | |

Neutral-White Bin Structure

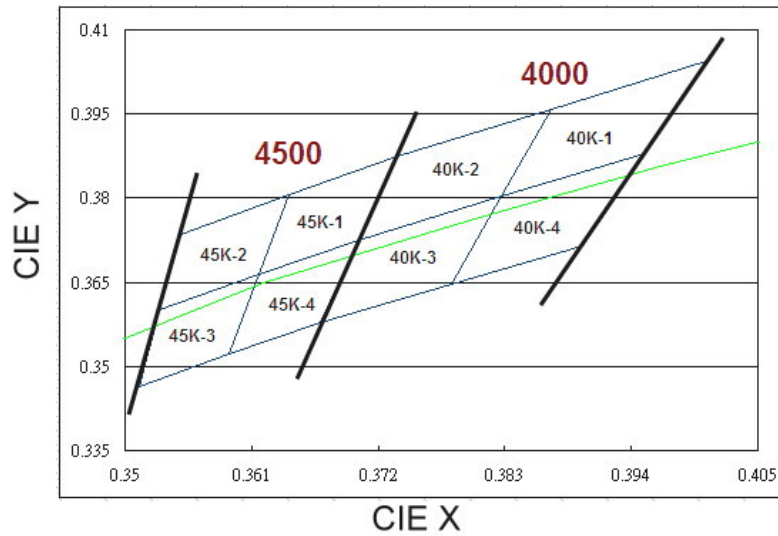

Neutral-White Bin Coordinates

4000K

| Bin | CIE X | CIE Y |
|-----------------------------|-------|-------|
| 40K-1 | 0.387 | 0.396 |
| | 0.383 | 0.380 |
| | 0.395 | 0.388 |
| | 0.401 | 0.404 |
| Reference Range: 3710~4000K | | |

| Bin | CIE X | CIE Y |
|-----------------------------|-------|-------|
| 40K-2 | 0.374 | 0.387 |
| | 0.370 | 0.373 |
| | 0.383 | 0.380 |
| | 0.387 | 0.396 |
| Reference Range: 4000~4260K | | |

| Bin | CIE X | CIE Y |
|-----------------------------|-------|-------|
| 40K-4 | 0.383 | 0.380 |
| | 0.378 | 0.365 |
| | 0.390 | 0.372 |
| | 0.395 | 0.388 |
| Reference Range: 3710~4000K | | |

| Bin | CIE X | CIE Y |
|-----------------------------|-------|-------|
| 40K-3 | 0.370 | 0.373 |
| | 0.367 | 0.358 |
| | 0.378 | 0.365 |
| | 0.383 | 0.380 |
| Reference Range: 4000~4260K | | |

4500K

| Bin | CIE X | CIE Y |
|-----------------------------|-------|-------|
| 45K-1 | 0.364 | 0.381 |
| | 0.362 | 0.366 |
| | 0.370 | 0.373 |
| | 0.374 | 0.387 |
| Reference Range: 4260~4500K | | |

| Bin | CIE X | CIE Y |
|-----------------------------|-------|-------|
| 45K-2 | 0.355 | 0.374 |
| | 0.353 | 0.360 |
| | 0.362 | 0.366 |
| | 0.364 | 0.381 |
| Reference Range: 4500~4745K | | |

| Bin | CIE X | CIE Y |
|-----------------------------|-------|-------|
| 45K-4 | 0.362 | 0.366 |
| | 0.359 | 0.352 |
| | 0.367 | 0.358 |
| | 0.370 | 0.373 |
| Reference Range: 4260~4500K | | |

| Bin | CIE X | CIE Y |
|-----------------------------|-------|-------|
| 45K-3 | 0.353 | 0.360 |
| | 0.351 | 0.347 |
| | 0.359 | 0.352 |
| | 0.362 | 0.366 |
| Reference Range: 4500~4745K | | |

Warm-White Bin Structure

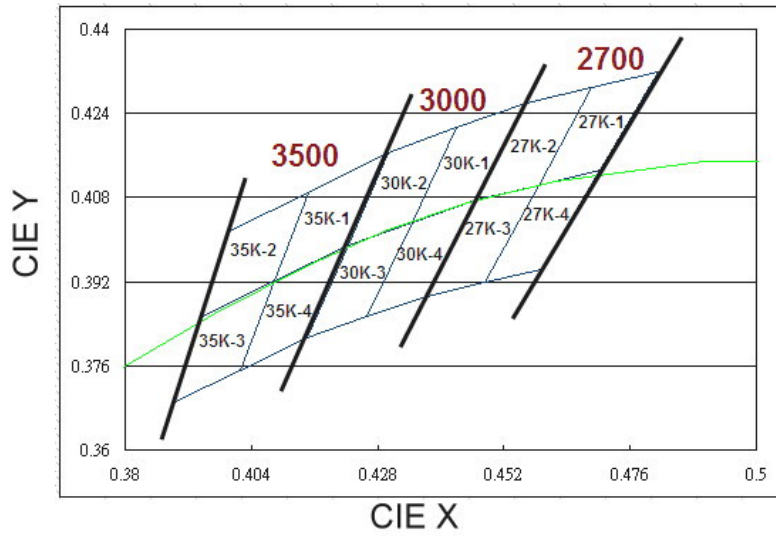

Warm-White Bin Coordinates

2700K

| Bin | CIE X | CIE Y |
|-----------------------------|-------|-------|
| 27K-1 | 0.469 | 0.429 |
| | 0.459 | 0.410 |
| | 0.470 | 0.413 |
| | 0.481 | 0.432 |
| Reference Range: 2580~2700K | | |

| Bin | CIE X | CIE Y |
|-----------------------------|-------|-------|
| 27K-2 | 0.456 | 0.426 |
| | 0.447 | 0.408 |
| | 0.459 | 0.410 |
| | 0.469 | 0.429 |
| Reference Range: 2700~2870K | | |

| Bin | CIE X | CIE Y |
|-----------------------------|-------|-------|
| 27K-4 | 0.459 | 0.410 |
| | 0.448 | 0.392 |
| | 0.459 | 0.394 |
| | 0.470 | 0.413 |
| Reference Range: 2580~2700K | | |

| Bin | CIE X | CIE Y |
|-----------------------------|-------|-------|
| 27K-3 | 0.447 | 0.408 |
| | 0.437 | 0.389 |
| | 0.448 | 0.392 |
| | 0.459 | 0.410 |
| Reference Range: 2700~2870K | | |

3000K

| Bin | CIE X | CIE Y |
|-----------------------------|-------|-------|
| 30K-1 | 0.443 | 0.421 |
| | 0.435 | 0.403 |
| | 0.447 | 0.408 |
| | 0.456 | 0.426 |
| Reference Range: 2870~3000K | | |

| Bin | CIE X | CIE Y |
|-----------------------------|-------|-------|
| 30K-2 | 0.430 | 0.417 |
| | 0.422 | 0.399 |
| | 0.435 | 0.403 |
| | 0.443 | 0.421 |
| Reference Range: 3000~3220K | | |

| Bin | CIE X | CIE Y |
|-----------------------------|-------|-------|
| 30K-4 | 0.435 | 0.403 |
| | 0.426 | 0.385 |
| | 0.437 | 0.389 |
| | 0.447 | 0.408 |
| Reference Range: 2870~3000K | | |

| Bin | CIE X | CIE Y |
|-----------------------------|-------|-------|
| 30K-3 | 0.422 | 0.399 |
| | 0.415 | 0.381 |
| | 0.426 | 0.385 |
| | 0.435 | 0.403 |
| Reference Range: 3000~3220K | | |

3500K

| Bin | CIE X | CIE Y |
|-----------------------------|-------|-------|
| 35K-1 | 0.415 | 0.409 |
| | 0.408 | 0.392 |
| | 0.422 | 0.399 |
| | 0.430 | 0.417 |
| Reference Range: 3220~3500K | | |

| Bin | CIE X | CIE Y |
|-----------------------------|-------|-------|
| 35K-2 | 0.400 | 0.402 |
| | 0.394 | 0.385 |
| | 0.408 | 0.392 |
| | 0.415 | 0.409 |
| Reference Range: 3500~3710K | | |

| Bin | CIE X | CIE Y |
|-----------------------------|-------|-------|
| 35K-4 | 0.408 | 0.392 |
| | 0.402 | 0.375 |
| | 0.415 | 0.381 |
| | 0.422 | 0.399 |
| Reference Range: 3220~3500K | | |

| Bin | CIE X | CIE Y |
|-----------------------------|-------|-------|
| 35K-3 | 0.394 | 0.385 |
| | 0.389 | 0.369 |
| | 0.402 | 0.375 |
| | 0.408 | 0.392 |
| Reference Range: 3500~3710K | | |

Note: Currently available typical CCT ranges are 3000K, 5700K, and 6500K CCT.

Forward Voltage Bins

| Group Name | Bins |
|------------|-------------|
| A | U1+U2+U3+U4 |
| B | U2+U3+U4+V1 |
| C | U4+V1+V2+V3 |
| D | V1+V2+V3+V4 |
| H | U0+U1+U2+U3 |

| Bin | Minimum Forward Voltage (V) | Maximum Forward Voltage (V) |
|-----|-----------------------------|-----------------------------|
| U0 | 1.60 | 1.75 |
| U1 | 1.75 | 2.05 |
| U2 | 2.05 | 2.35 |
| U3 | 2.35 | 2.65 |
| U4 | 2.65 | 2.95 |
| V1 | 2.95 | 3.25 |
| V2 | 3.25 | 3.55 |
| V3 | 3.55 | 3.85 |
| V4 | 3.85 | 4.15 |

Notes:

1. Forward voltage measurement tolerance: $\pm 0.1V$.
2. Forward voltage bins are defined at $I_F=350mA$ operation.
3. Other Forward Voltage bins for White LEDs available upon request. Please contact your local Everlight sales office.
4. White led Voltage Bins : U4+V1+V2

Color Bins

| Group | Bin | Minimum Dominant Wavelength (nm) | Maximum Dominant Wavelength (nm) |
|------------------------|-----|----------------------------------|----------------------------------|
| B (Blue) | 1 | 430 | 435 |
| | 2 | 435 | 440 |
| | 3 | 440 | 445 |
| | 4 | 445 | 450 |
| | 5 | 450 | 455 |
| | 6 | 455 | 460 |
| | 7 | 460 | 465 |
| | 8 | 465 | 470 |
| | 9 | 470 | 475 |
| | A | 475 | 480 |
| | B | 480 | 485 |
| C (Cyan) | 1 | 490 | 495 |
| | 2 | 495 | 500 |
| | 3 | 500 | 505 |
| | 4 | 505 | 510 |
| | 5 | 510 | 515 |
| | 6 | 515 | 520 |
| G (Green) | 1 | 520 | 525 |
| | 2 | 525 | 530 |
| | 3 | 530 | 535 |
| | 4 | 535 | 540 |
| | 5 | 540 | 545 |
| | 6 | 545 | 550 |
| A (Amber) | 1 | 580 | 582.5 |
| | 2 | 582.5 | 585 |
| | 3 | 585 | 587.5 |
| | 4 | 587.5 | 590 |
| | 5 | 590 | 592.5 |
| | 6 | 592.5 | 595 |
| R (Red) | 3 | 610 | 615 |
| | 4 | 615 | 620 |
| | 5 | 620 | 625 |
| | 6 | 625 | 630 |
| D (Deep-Red) | 1 | 635 | 640 |
| | 2 | 640 | 645 |
| | 3 | 645 | 650 |
| | 4 | 650 | 655 |
| | 5 | 655 | 660 |
| | 6 | 660 | 665 |
| | 7 | 665 | 670 |
| | 8 | 670 | 675 |
| F (Far-Red) | 1 | 700 | 710 |
| | 2 | 710 | 715 |
| | 3 | 715 | 720 |
| | 4 | 720 | 725 |
| | 5 | 725 | 730 |
| | 6 | 730 | 735 |
| | 7 | 735 | 740 |
| | 8 | 740 | 745 |

Notes:

1. Dominant / Peak wavelength measurement tolerance: $\pm 1\text{nm}$.
2. Dominant / Peak wavelength bins are defined at $I_F=350\text{ mA}$ operation.
3. The range of wavelength in Royal-Blue, Deep-Red and Far-Red is described as peak-wavelength.

Optical Characteristics

| Color | Part Number | Dominant Wavelength λ_D Peak Wavelength λ_P Color Temperature CCT | | | Typical Temperature Coefficient of Dominant Wavelength ($\text{nm}/^\circ\text{C}$)- $(\Delta\lambda_D/\Delta T_J)$ | Typical Viewing Angle (degrees) $2\theta_{1/2}$ |
|---------------|--------------|---|-------|-------|--|--|
| | | Min. | Typ. | Max. | | |
| Cool-White | ELSW – XX1CX | 4745K | 5700K | 7050K | --- | Note 5 |
| Neutral-White | ELSW – XX1NX | 3710K | 4260K | 4745K | --- | Note 5 |
| Warm-White | ELSW– XX1MX | 2580K | 3000K | 3710K | --- | Note 5 |
| Red | ELSW– XX1RX | 620nm | --- | 630nm | 0.05 | 120 |
| Orange | ELSW – XX1OX | 610nm | --- | 620nm | 0.08 | 120 |
| Amber | ELSW– XX1YX | 585nm | --- | 595nm | 0.1 | 120 |
| Cyan | ELSW – XX1AX | 490nm | --- | 505nm | 0.05 | 120 |
| Green | ELSW – XX1GX | 520nm | --- | 535nm | 0.05 | 120 |
| Blue | ELSW – XX1BX | 460nm | --- | 470nm | 0.05 | 120 |
| Deep-Red | ELSW – XX1EX | 645nm | --- | 675nm | 0.08 | 120 |
| Far-Red | ELSW – XX1FX | 715nm | --- | 745nm | 0.04 | 120 |

Notes:

1. The test tolerance of Everlight is $\pm 0.5\text{nm}$ for dominant wavelength, $\pm 5\%$ for CCT.
2. Viewing angle is the width of half the light output intensity in all directions of 180° .
3. All Cool-White, Neutral-White, Warm-White, and dominant wavelength below 550nm LEDs are made with Indium Gallium Nitride (InGaN).
4. All LEDs with dominant wavelength exceeding 550nm are made with Aluminum Indium Gallium Phosphide (AlInGaP).
5. Typical view angle of ELSW-XX1XX-0C and ELSW-XX1XX-0V series is 100° . Typical view angle of ELSW-XX1XX-0L series is 120° .

Mechanical Dimension

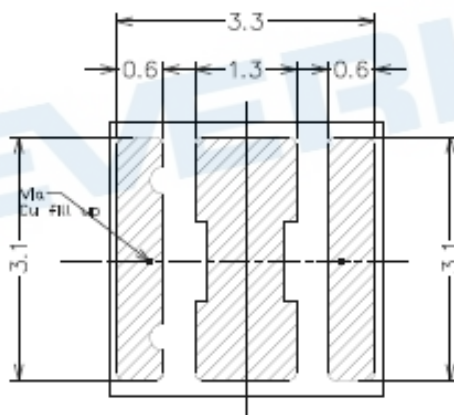
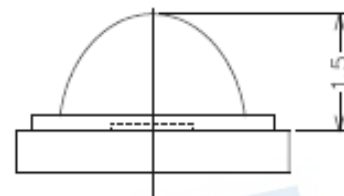
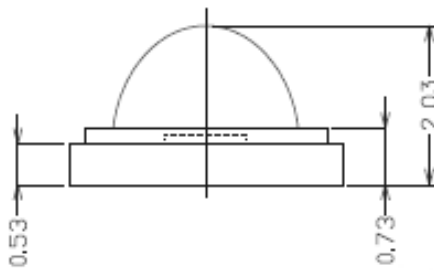
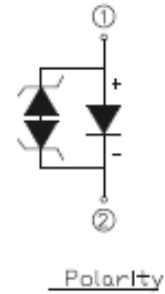
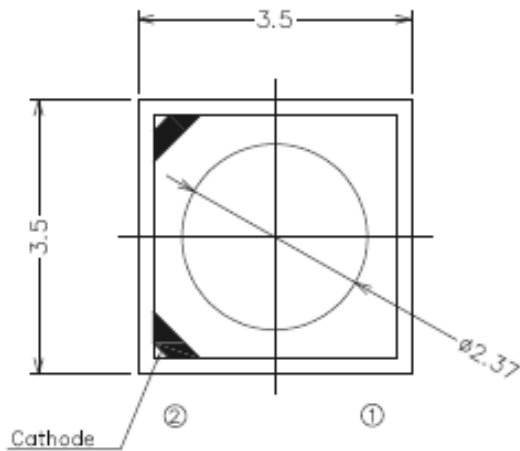

Solder pad design

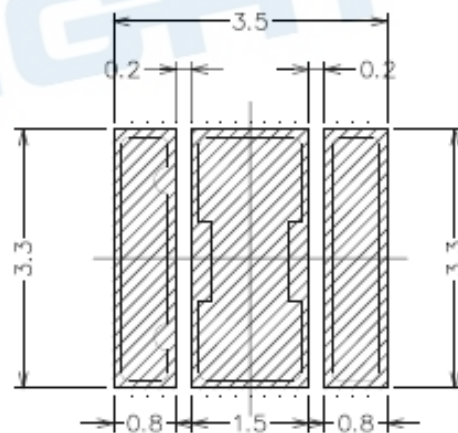

Soldering patterns

Notes:

1. Dimensions are in millimeters.
2. Tolerances unless mentioned are $\pm 0.15\text{mm}$.
3. The thermal pad is electrically isolated from the Anode and Cathode contact pads.
4. Do not handle the device by the lens. Incorrect force applied to the lens may lead to the failure of devices.

Pad Configuration

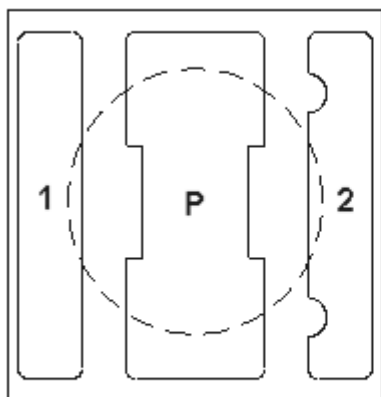

BOTTOM VIEW

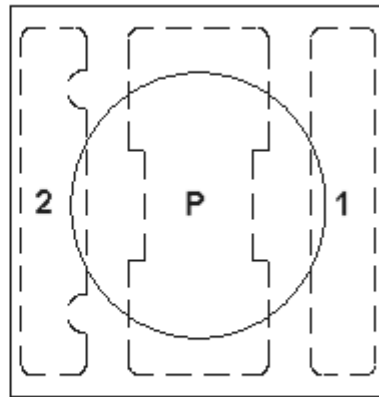

TOP VIEW

| PAD | FUNCTION |
|-----|-------------|
| 1 | ANODE |
| 2 | CATHODE |
| P | THERMAL PAD |

Reflow Soldering Characteristics

For Reflow Process

- ELSW series are suitable for SMT processes.
- Curing of glue in oven must be according to standard operation flow processes.

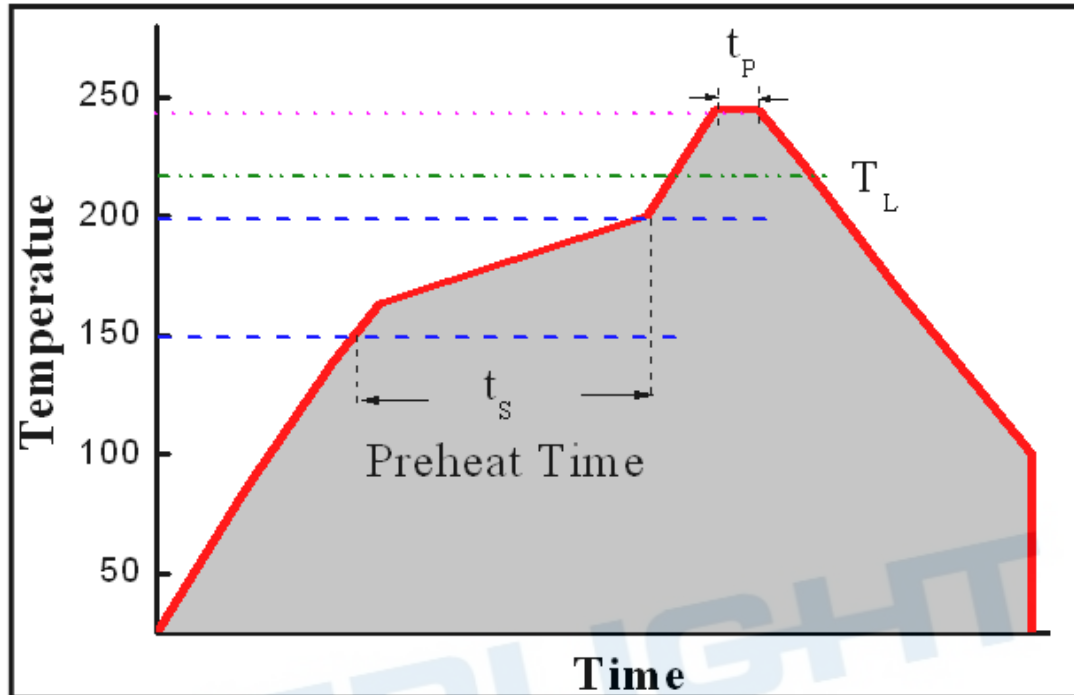

| Profile Feature | Lead Free Assembly |
|------------------------------|--------------------|
| Ramp-Up Rate | 2-3 °C/S |
| Preheat Temperature | 150-200 °C |
| Preheat Time (t_s) | 60-120 S |
| Liquid Temperature (T_L) | 217 °C |
| Time maintained above T_L | 60-90 S |
| Peak Temperature (T_p) | 240±5 °C |
| Peak Time (t_p) | Max 20 S |
| Ramp-Down Rate | 3-5 °C/S |

- Reflow soldering should not be done more than twice.
- In soldering process, stress on the LEDs during heating should be avoided.
- After soldering, do not bend the circuit board.

Wavelength Characteristics

For Far-Red, Deep-Red, Red, Amber, Yellow, Green, Blue, Violet-Blue
@ Thermal Pad Temperature = 25°C

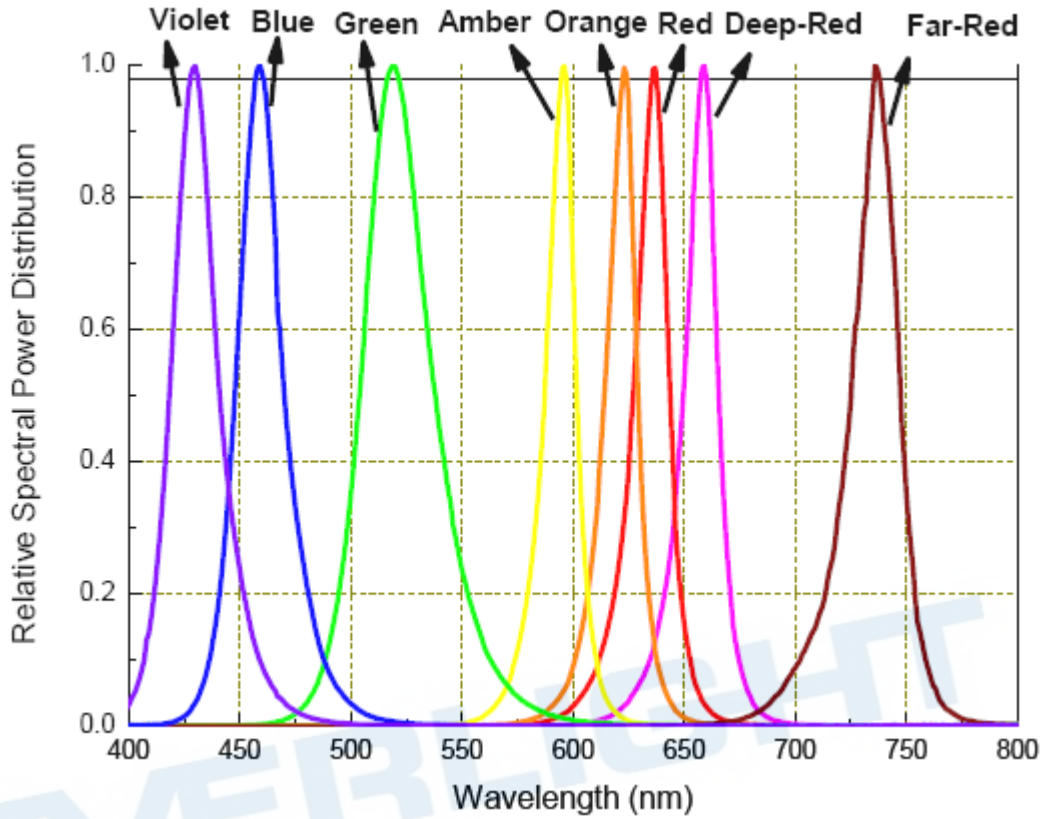

For Cool-White, @ Thermal Pad Temperature = 25°C

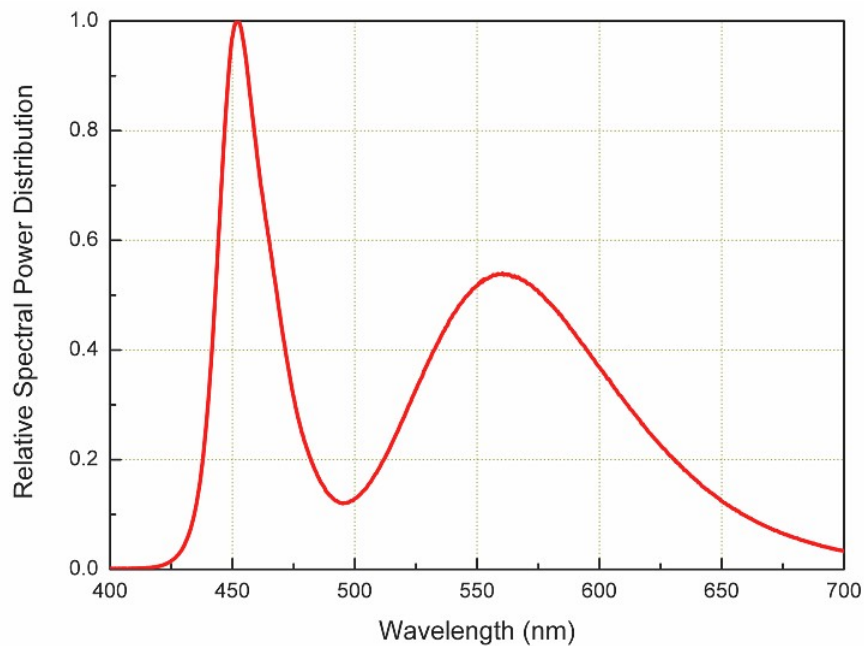

For Neutral-White, @ Thermal Pad Temperature = 25°C

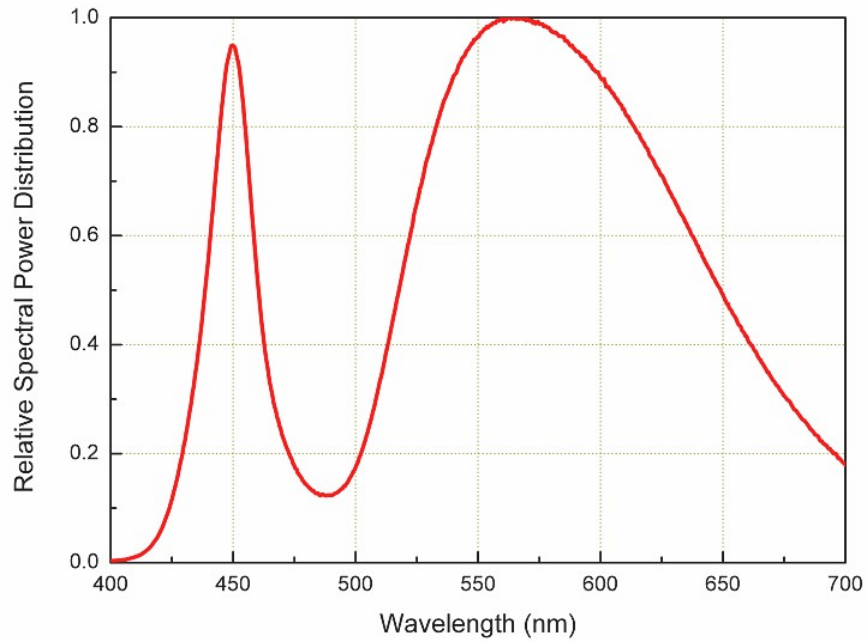

For Warm-White, @ Thermal Pad Temperature = 25°C

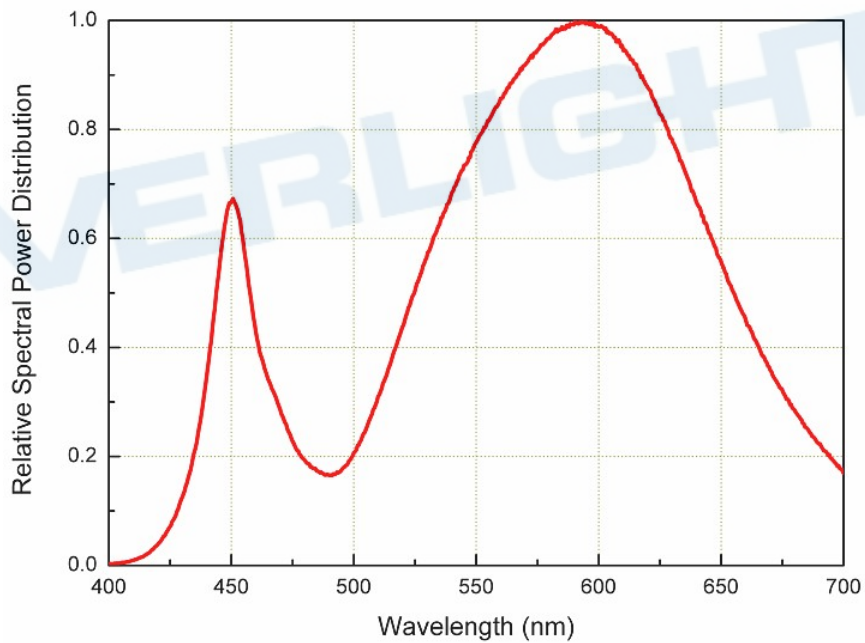

Typical Light Output Characteristic V.S. Thermal Pad Temperature

Cool-White, Neutral-White, Warm-White, Green, Blue for 350mA Drive Current

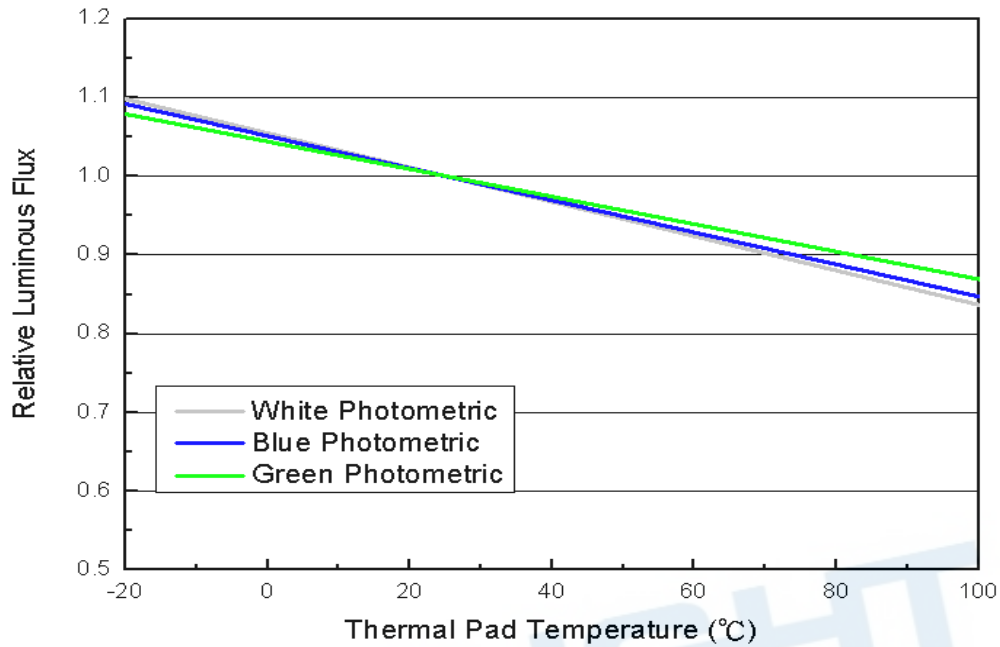

Red, Orange, Amber for 350mA Drive Current

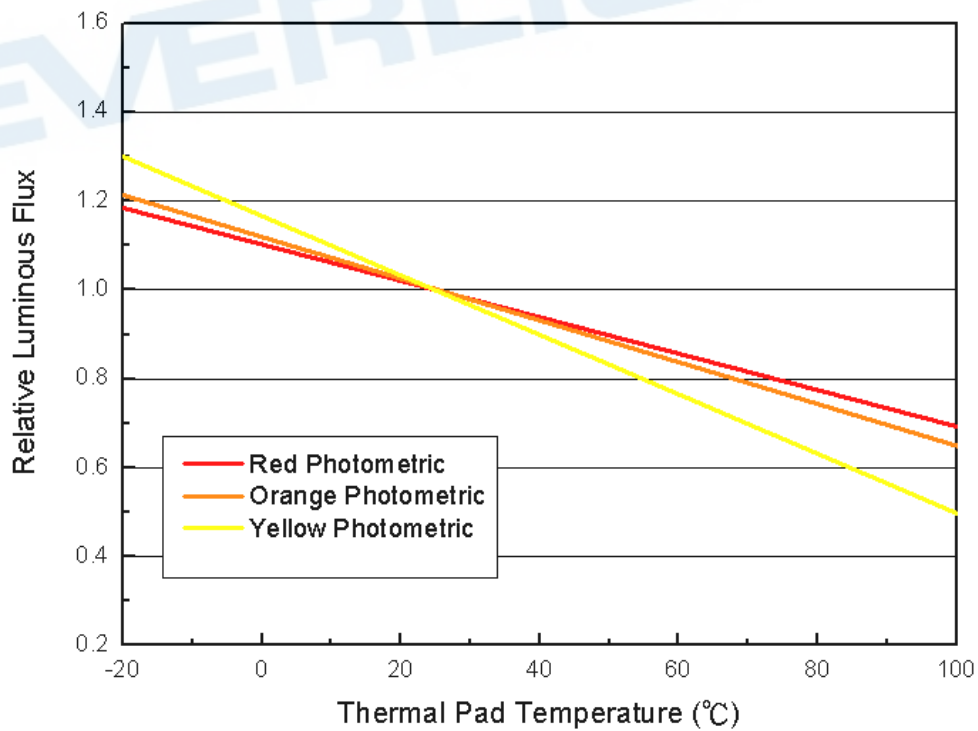

Typical Electrical Characteristics

For Cool-White, Neutral-White, Warm-White, Green, Blue
@ Thermal Pad Temperature = 25°C

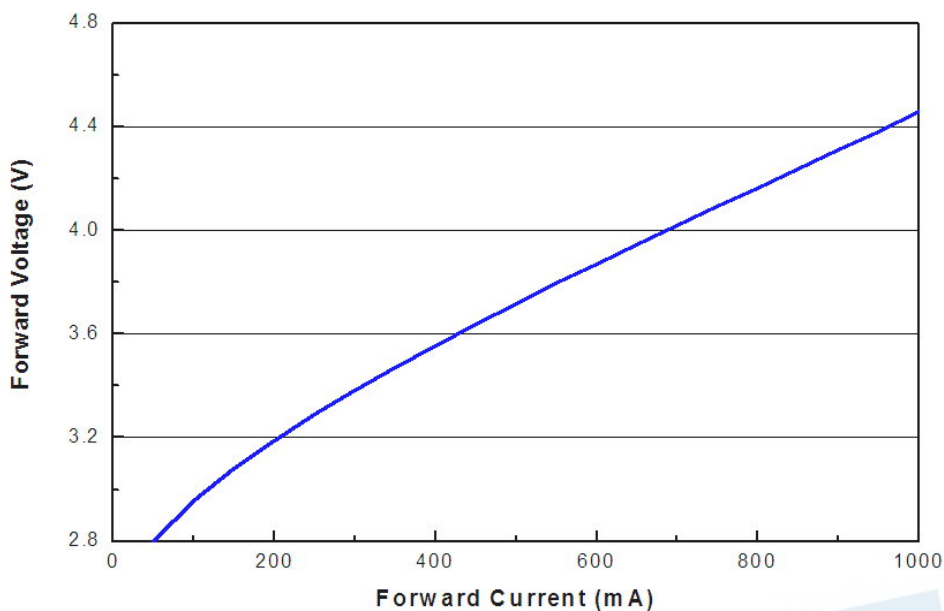

For Red, Orange, Amber,
@ Thermal Pad Temperature = 25°C

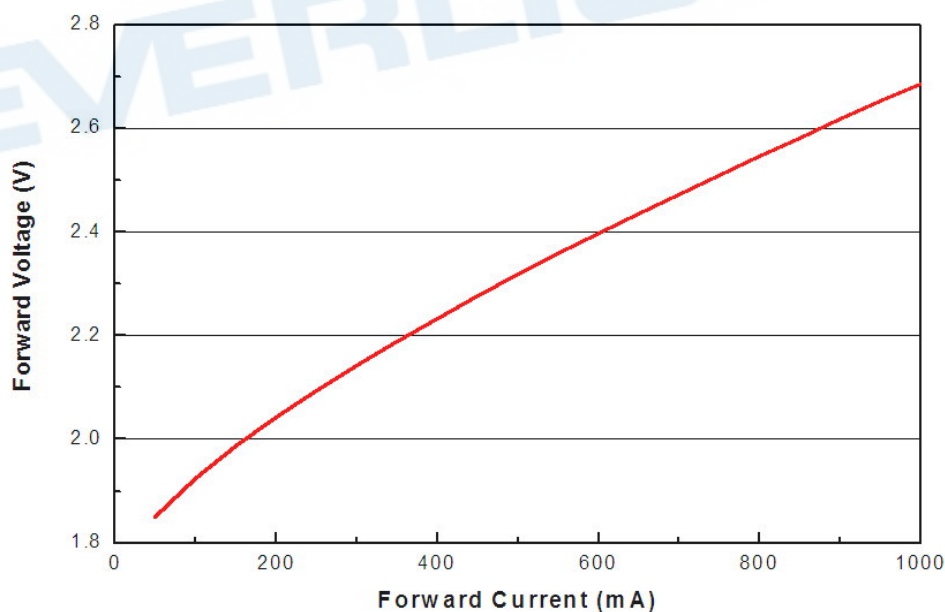

Typical Relative Luminous Flux V.S. Forward Current

For Cool-White, Neutral-White, Warm-White
@ Thermal Pad Temperature = 25°C

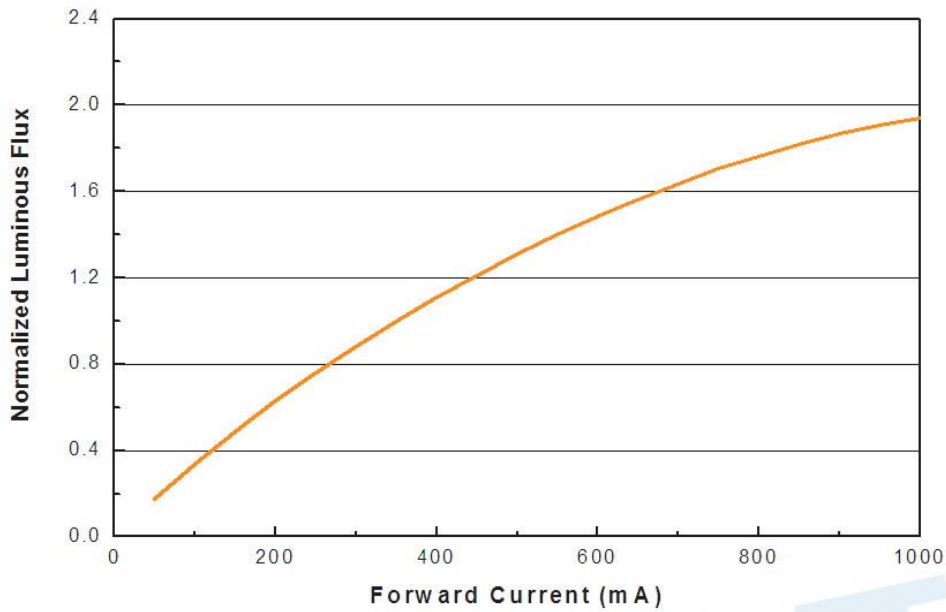

For Green, Blue, @ Thermal Pad Temperature = 25°C

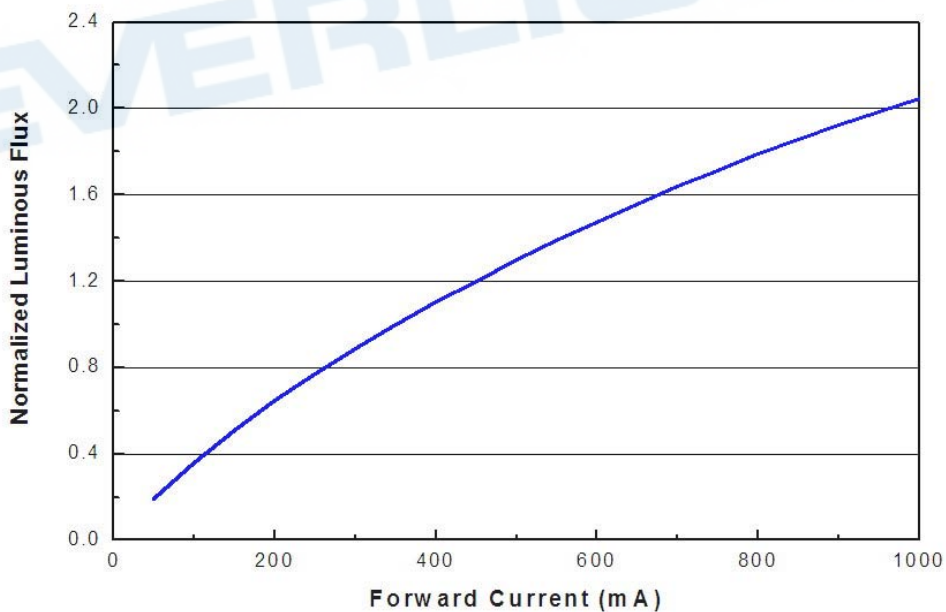

For Red, Orange, Amber,
@ Thermal Pad Temperature = 25°C

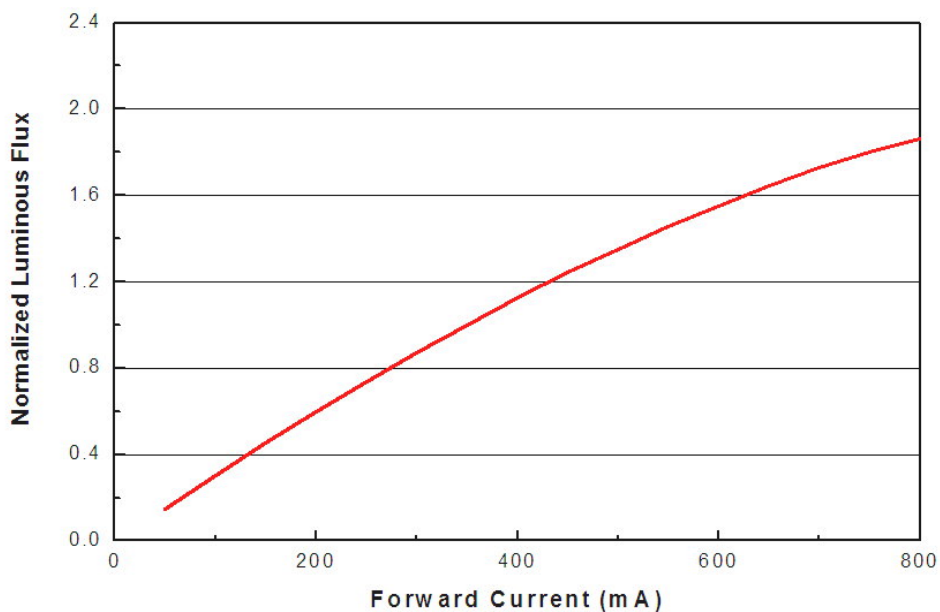

EVERLIGHT

Typical Wavelength & CCT Shift Characteristics V.S. Forward Current

For Cool-White @ Thermal Pad Temperature = 25°C

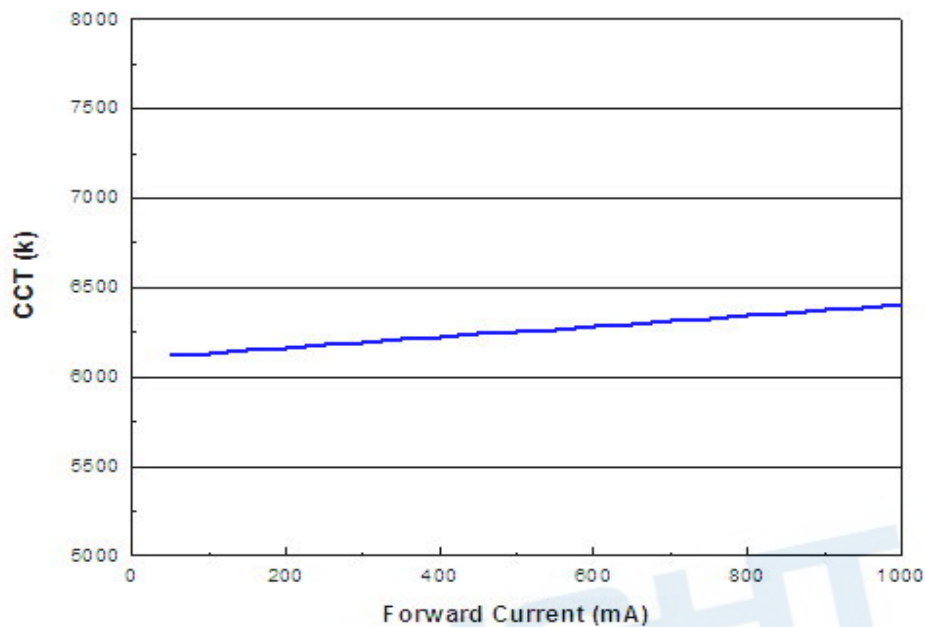

For Neutral-White @ Thermal Pad Temperature = 25°C

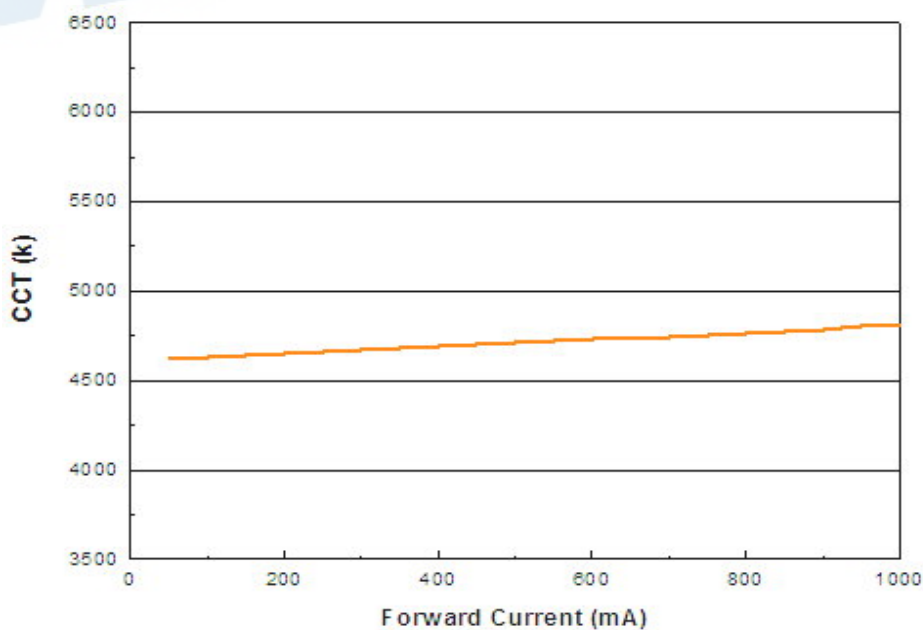

For Warm-White @ Thermal Pad Temperature = 25°C

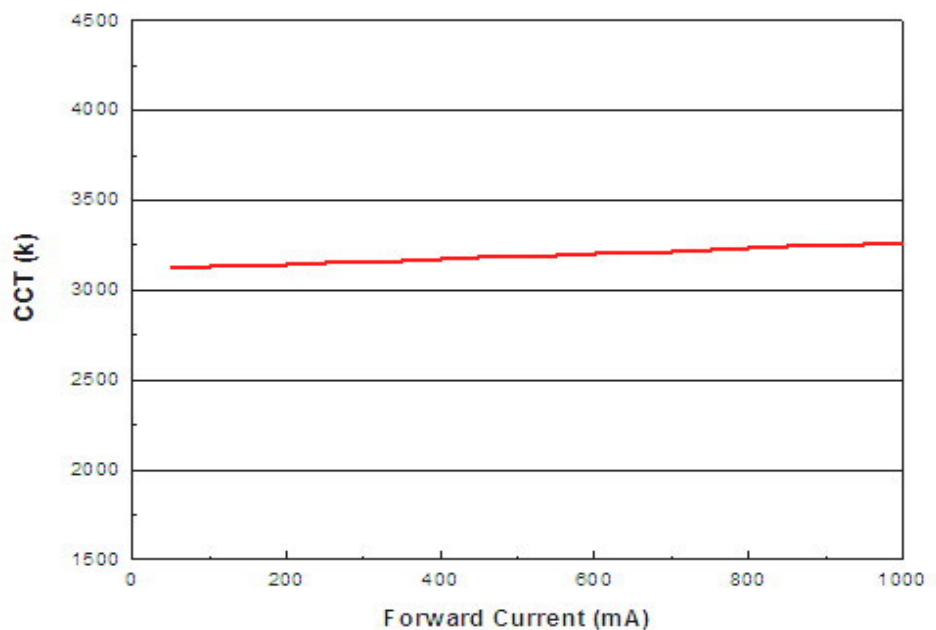

For Blue @ Thermal Pad Temperature = 25°C

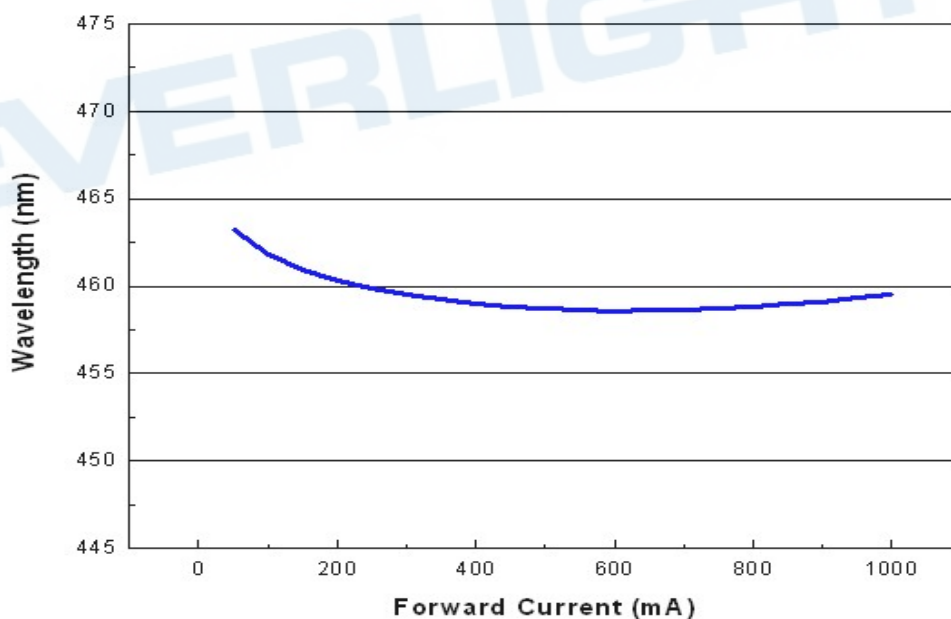

For Green @ Thermal Pad Temperature = 25°C

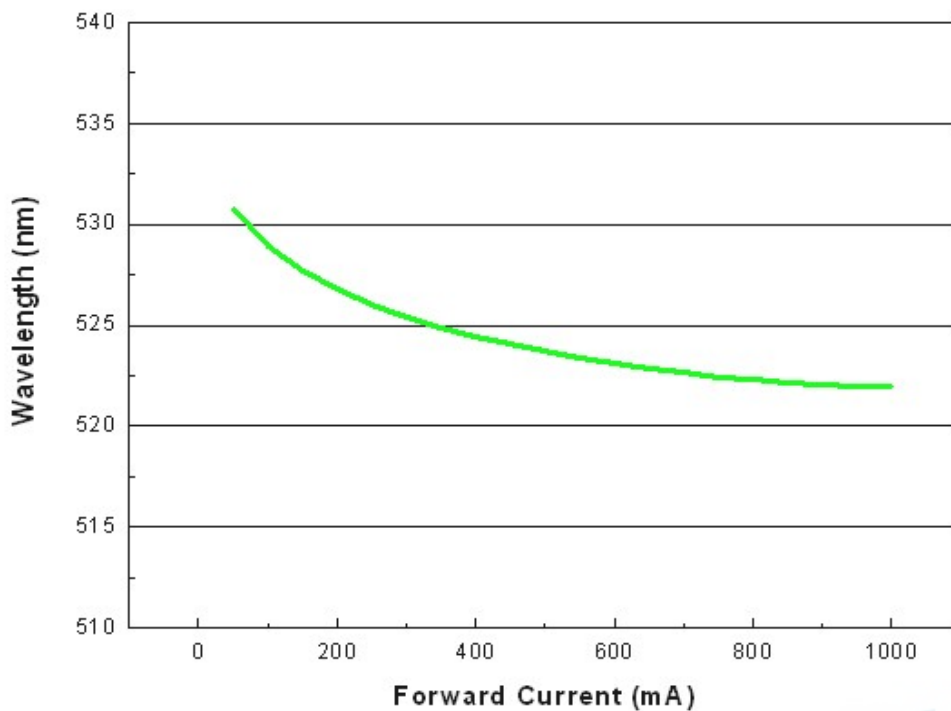

For Red @ Thermal Pad Temperature = 25°C

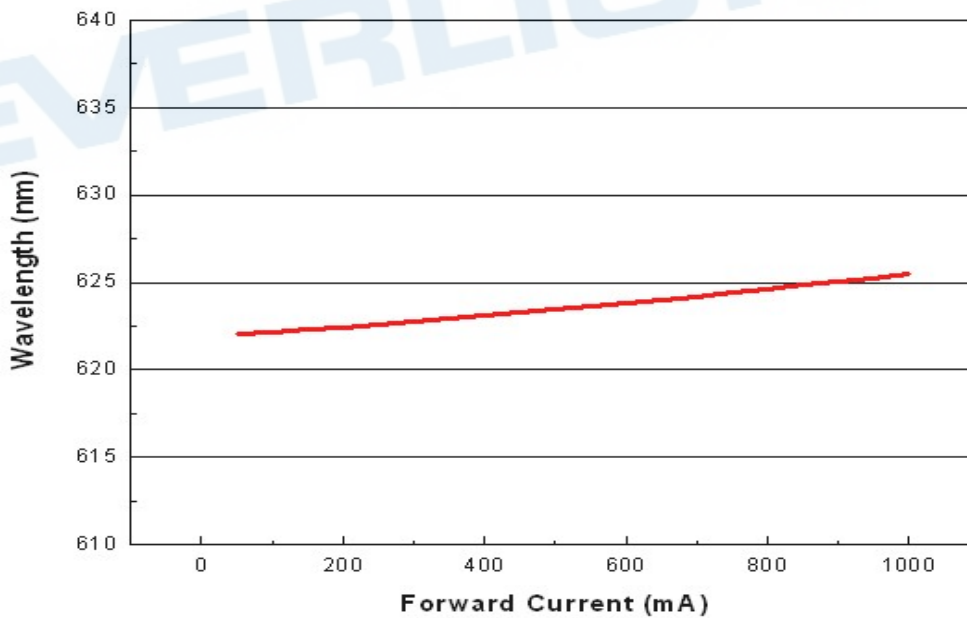

Relative Flux and Forward Voltage V.S. Junction Temperature (IF = 350 mA)

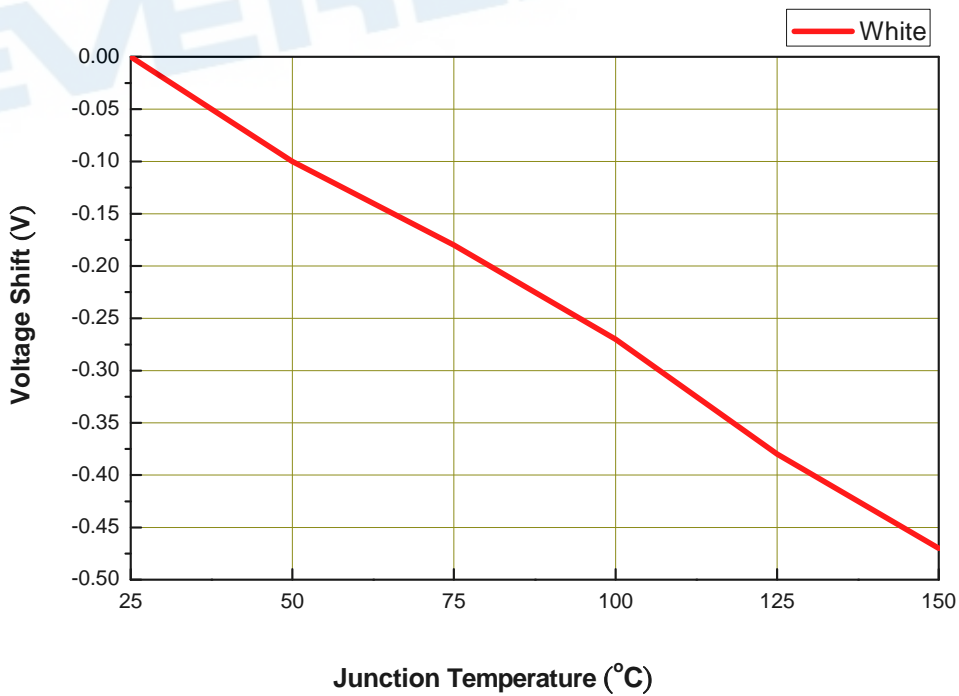
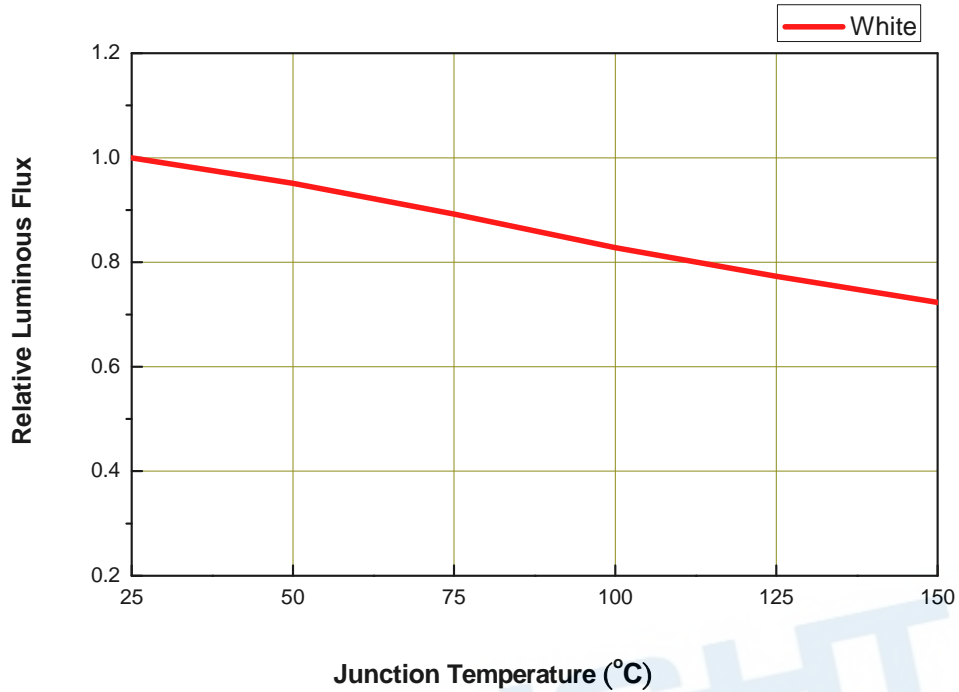

Current Derating Curves

Current Derating Curve for 700mA Drive Current
Cool-White, Neutral-White, Warm-White, Green, Cyan, Blue, Royal-Blue
Far-Red, Deep-Red, Red, Amber, Yellow

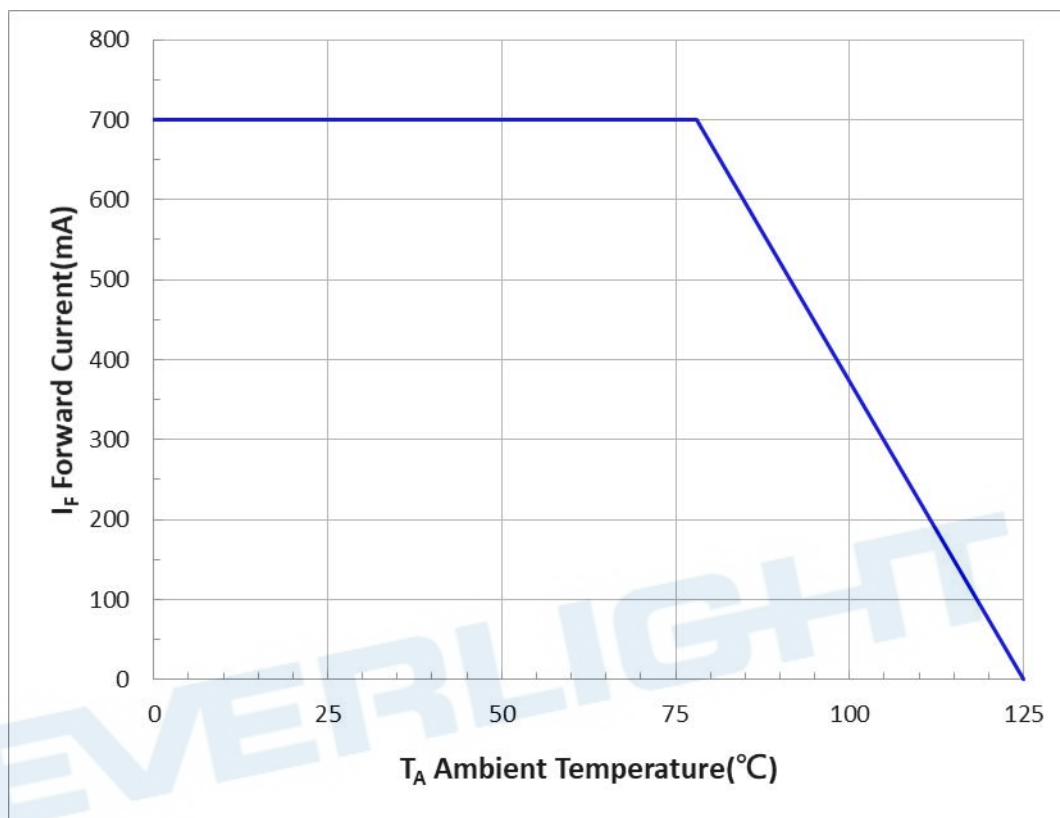

Note:

The current derating curves are depending on the thermal resistance between the junction to the soldering pad.

Typical Radiation Patterns

Shwo series: Typical Diagram Characteristics of Radiation for Cool-White, Neutral-White, Warm-White

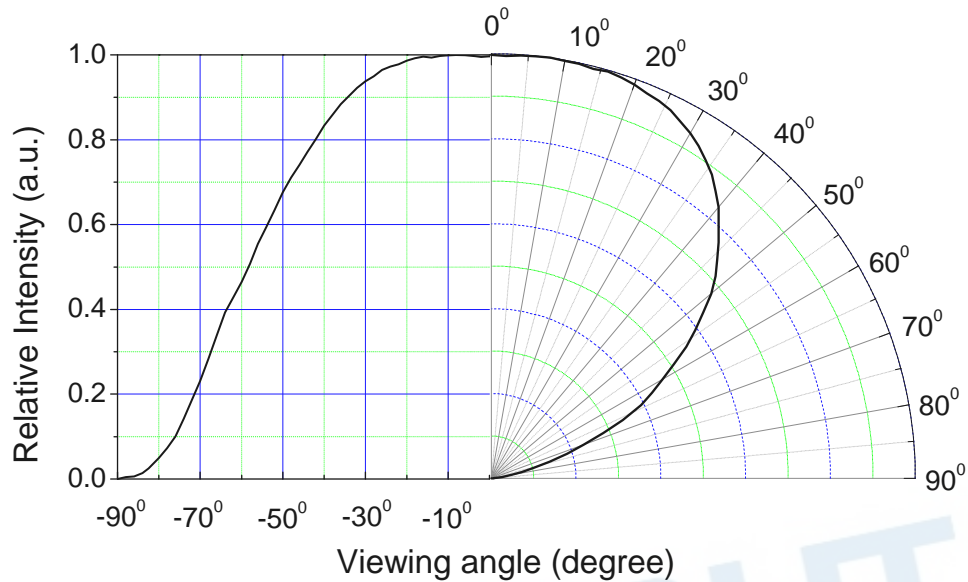

Notes:

1. $2\theta_{1/2}$ is the off axis angle from lamp centerline where the luminous intensity is 1/2 of the peak value.
2. View angle tolerance is $\pm 5^\circ$.

Emitter Tape Packaging

Carrier Tape Dimensions as the following:

Order Qty.: > 2Kpcs, MPQ: min. 400pcs (incl. 400pcs / 800pcs) per reel.

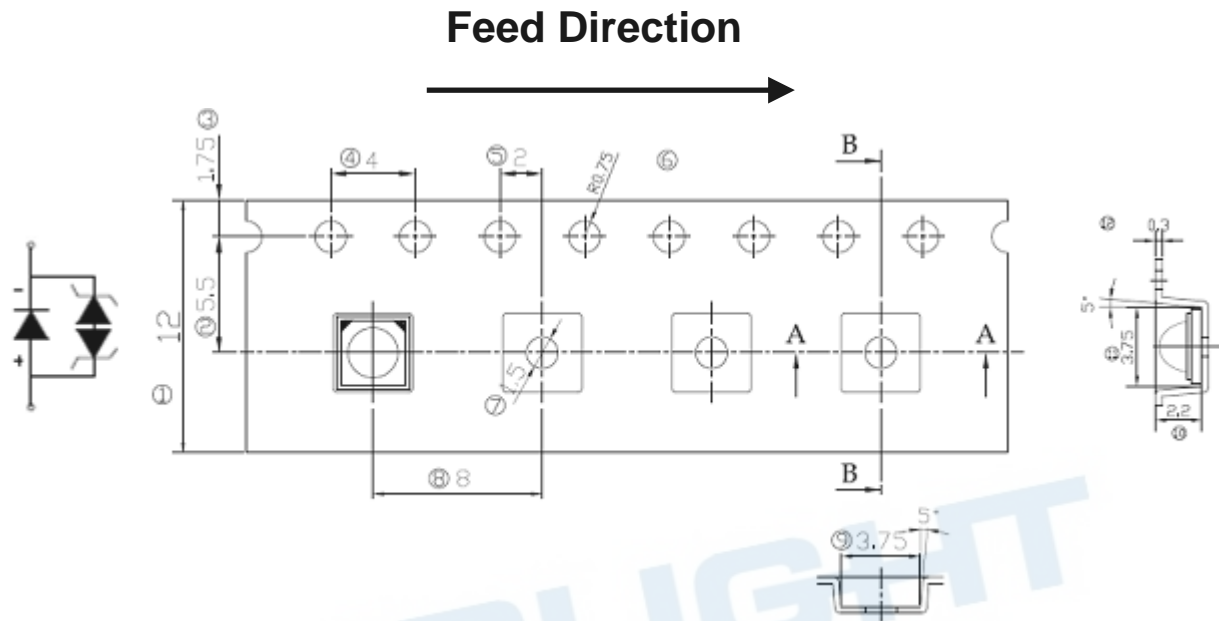

Notes:

1. Dimensions are in millimeters.
2. Tolerances for fixed dimensions are $\pm 0.1\text{mm}$.

Moisture Resistant Packaging

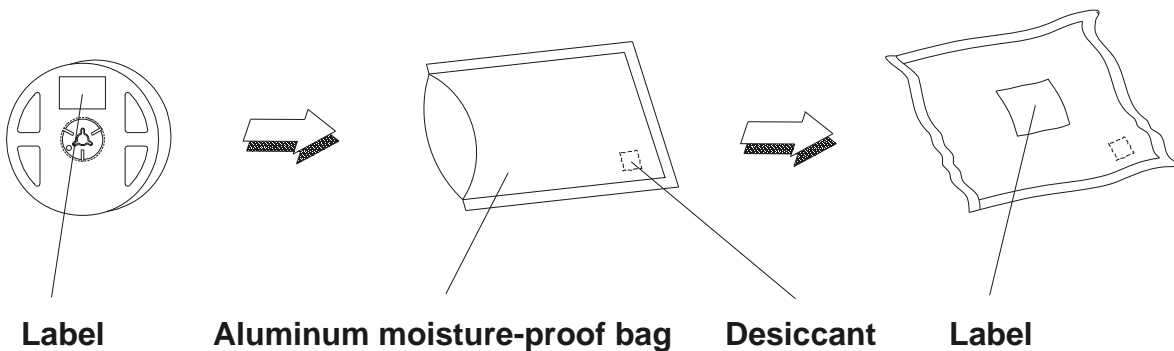

Emitter Reel Packaging

Reel Dimensions

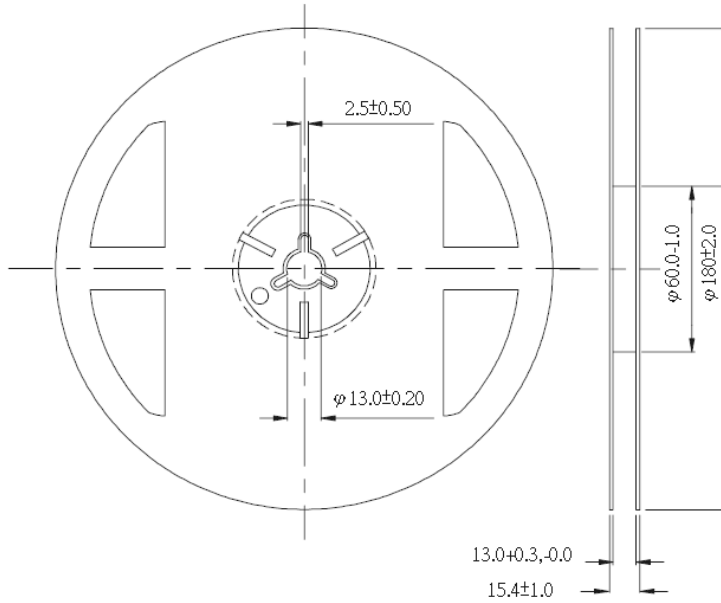

Notes:

1. Dimensions are in millimeters.
2. Tolerances unless mentioned are ± 0.1 mm.

Product Labeling

Label Explanation

CPN: Customer Specification (when required)

P/N : Everlight Production Number

QTY: Packing Quantity

CAT: Luminous Flux (Brightness) Bin

HUE: Color Bin

REF: Forward Voltage Bin

LOT No: Lot Number

MADE IN TAIWAN: Production Place

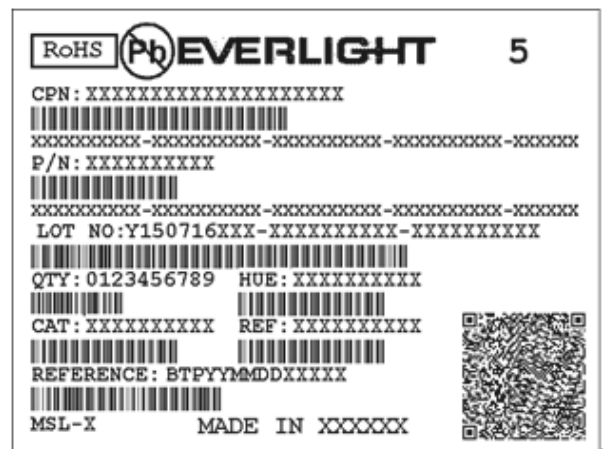

Storage Conditions

- Before the package is opened. The LEDs should be stored at 30°C or less and 85%RH or less after being shipped from Everlight and the storage life limits are 1 year. The LEDs can be stored up to 3 years If in a sealed container with a nitrogen atmosphere and moisture absorbent material.
- After opening the package: The LED's floor life is 1 year under 30°C or less and 60%RH or less. The LED should be soldered with 168hrs (7days) after opening the package. If unused LEDs remain, it should be stored in moisture proof packages.
- If the moisture absorbent material (silica gel) has faded away or the LEDs have exceeded the storage time, baking treatment should be performed using the following conditions. Baking treatment: 60±5°C for 24 hours.

EVERLIGHT



Report No.: OA-2011-80004

Page 1 of 39

Issued: Sep. 05, 2012

TEST REPORT

The following tested product(s) were submitted and identified by the vendor as:

Applicant : EVERLIGHT ELECTRONICS CO., LTD.
Address of Applicant : No. 6-8, Zhonghua Rd., Shulin Dist., New Taipei City
23860, Taiwan
Testing Laboratory : SGS Taiwan Ltd., Optics Laboratory
Testing Address : 33, Wu Chyuan Rd., New Taipei Industrial Park, New
Taipei City, Taiwan 24886
Product Name : Shwo Series LED Component
Model / Serial Number : Shwo (3000 K)
Manufacturer : EVERLIGHT ELECTRONICS CO., LTD.
Rating : DC 350 mA, 1 W
Test Standard/Method : IES LM-80-08 Approved Method: Measuring Lumen
Maintenance of LED Light Sources
Date of Issue : Sep. 05, 2012

The submitted products have been tested as requested and the following results were obtained, and the report, not applicable for lawsuit, refers only to the unit(s) submitted for test.

Test Results : -PLEASE SEE ATTACHED SHEETS-

Signed for and on behalf of
SGS TAIWAN Ltd.

Calvin Tzou
Technical Manager



Report No.: OA-2011-80004

Page 2 of 39

Issued: Sep. 05, 2012

1 DATE OF RECEIPT OF SAMPLES

Aug. 18, 2011

2 DATE(S) OF PERFORMANCE OF THE TEST

Sep. 14, 2011 ~ Jun. 22, 2012

3 IDENTITY OF SAMPLES

| Quantity | Model | Serial Number |
|----------|---------------|-----------------------|
| 25 | Shwo (3000 K) | # A01 - # A25 (25 °C) |
| 25 | Shwo (3000 K) | # B01 - # B25 (55 °C) |
| 25 | Shwo (3000 K) | # C01 - # C25 (85 °C) |

4 TEST ITEMS

4.1 Data Summary of Lumen and Color Maintenance

Test results were concluded by different Case Temperatures (Ts).

4.2 Lumen Maintenance and Color Maintenance Test

Testing specifications by different case temperatures according to IES LM-80-08 Approved Method: Measuring Lumen Maintenance of LED Light Sources and client's requirements were implemented per the following items.

4.2.1 Total Luminous Flux (Φ_v)

The test results of total luminous flux were implemented referring to Clause 2 PROPERTIES OF LEDS & Clause 6 MEASUREMENT OF LUMINOUS FLUX of CIE 127: 2007 2nd edition MRASUREMENT OF LEDS and IES LM-80-08 Approved Method: Measuring Lumen Maintenance of LED Light Sources, when the UUTs were powered with constant current of I_f .

4.2.2 Correlated Color Temperature (CCT), CIE Color Coordinate (CIE_x, CIE_y) & Chromaticity Shift ($\Delta u'v'$)

The test results of correlated color temperature were implemented referring to CIE 127:2007 2nd edition MRASUREMENT OF LEDS, CIE 15: 2004 COLORIMETRY.

The test results of color coordinate were implemented referring to CIE 127: 2007 2nd edition MRASUREMENT OF LEDS, CIE 15:2004 COLORIMETRY.



Report No.: OA-2011-80004

Page 3 of 39

Issued: Sep. 05, 2012

5 TEST CONDITIONS

Main Test Equipment:

| Name | Brand | Model | Traceability |
|-----------------------|-----------|----------|--------------|
| Spectroradiometer | Labsphere | CDS 2100 | NIST |
| Standard Light Source | Labsphere | SCL-600 | NIST |
| Source Meter | Keithley | 2400 | NMI |
| Digital Multimeter | Agilent | U1242A | NMI |

Environmental Conditions:

Temperature: (25 ± 1) °C

Relative Humidity: < 65 % RH

UUT Conditions:

Drive Current: DC 350 mA

Forward Voltage: DC 2.95 ~ 3.85 V

Power Consumption: 1 W

CCT: 3000 K

Package Dimension: L 3.5 mm x W 3.5 mm x H 2.03 mm

UUT Dimension: Φ 2.37 mm x H 1.5 mm

Prior operation: 0 hr

Total Operation Duration: 6000 hours

Product Specs: See Appendix A

Measurement Conditions:

Interval Time: 1000 hours

Warm up Time: < 1 minute (initial)

Relative measurement uncertainty: 2.8 % (95 % Confidence Level)



Report No.: OA-2011-80004

Page 4 of 39

Issued: Sep. 05, 2012

6 TEST RESULTS

6.1 Data Summary of Lumen and Color Maintenance

| Temp. | Initial(0hrs) | | Luminous Maintenance (%) | | | | | |
|-----------|---------------|--------------------|--------------------------|----------|----------|----------|----------|----------|
| | TLF(lm) | V _F (V) | 1000 hrs | 2000 hrs | 3000 hrs | 4000 hrs | 5000 hrs | 6000 hrs |
| 25°C Avg. | 68.10 | 3.31 | 102.7% | 100.3% | 100.1% | 99.8% | 99.2% | 98.5% |
| 55°C Avg. | 67.26 | 3.34 | 102.5% | 100.1% | 100.1% | 99.9% | 99.2% | 98.0% |
| 85°C Avg. | 67.94 | 3.31 | 102.4% | 100.2% | 99.3% | 98.8% | 97.8% | 96.2% |

| Temp. | Initial(0hrs) | | | Chromaticity Shift ($\Delta u'v'$) | | | | | |
|-----------|------------------|------------------|------|--------------------------------------|----------|----------|----------|----------|----------|
| | CIE _x | CIE _y | CCT | 1000 hrs | 2000 hrs | 3000 hrs | 4000 hrs | 5000 hrs | 6000 hrs |
| 25°C Avg. | 0.4311 | 0.3959 | 3033 | 0.0006 | 0.0005 | 0.0003 | 0.0007 | 0.0020 | 0.0008 |
| 55°C Avg. | 0.4311 | 0.3946 | 3019 | 0.0006 | 0.0005 | 0.0004 | 0.0004 | 0.0016 | 0.0007 |
| 85°C Avg. | 0.4316 | 0.3957 | 3021 | 0.0013 | 0.0012 | 0.0013 | 0.0014 | 0.0026 | 0.0015 |

Lumen maintenance life projection

Table 1: Report at each LM-80 Test Condition

| Description of LED Light Source Tested (manufacturer, model, catalog number) | | Test Condition 1 - 25°C Case Temp | | Test Condition 2 - 55°C Case Temp | | Test Condition 3 - 85°C Case Temp | |
|--|---------------|--|---------------|--|---------------|--|---------------|
| Sample size | 20 | Sample size | 20 | Sample size | 20 | Sample size | 20 |
| Number of failures | 0 | Number of failures | 0 | Number of failures | 0 | Number of failures | 0 |
| DUT drive current used in the test (mA) | 20 | DUT drive current used in the test (mA) | 20 | DUT drive current used in the test (mA) | 20 | DUT drive current used in the test (mA) | 20 |
| Test duration (hours) | 6,000 | Test duration (hours) | 6,000 | Test duration (hours) | 6,000 | Test duration (hours) | 6,000 |
| Test duration used for projection (hour to hour) | 1,000 - 6,000 | Test duration used for projection (hour to hour) | 1,000 - 6,000 | Test duration used for projection (hour to hour) | 1,000 - 6,000 | Test duration used for projection (hour to hour) | 1,000 - 6,000 |
| Tested case temperature (°C) | 25 | Tested case temperature (°C) | 55 | Tested case temperature (°C) | 85 | Tested case temperature (°C) | 85 |
| α | 6.996E-06 | α | 7.245E-06 | α | 1.114E-05 | α | 1.114E-05 |
| B | 1.026 | B | 1.025 | B | 1.030 | B | 1.030 |
| Calculated L70(6k) (hours) | 55,000 | Calculated L70(6k) (hours) | 53,000 | Calculated L70(6k) (hours) | 35,000 | Calculated L70(6k) (hours) | 35,000 |
| Reported L70(6k) (hours) | >36000 | Reported L70(6k) (hours) | >36000 | Reported L70(6k) (hours) | 35,000 | Reported L70(6k) (hours) | 35,000 |

DISCLAIMER

1. EVERLIGHT reserves the right(s) on the adjustment of product material mix for the specification.
2. The product meets EVERLIGHT published specification for a period of twelve (12) months from date of shipment.
3. The graphs shown in this datasheet are representing typical data only and do not show guaranteed values.
4. When using this product, please observe the absolute maximum ratings and the instructions for using outlined in these specification sheets. EVERLIGHT assumes no responsibility for any damage resulting from the use of the product which does not comply with the absolute maximum ratings and the instructions included in these specification sheets.
5. These specification sheets include materials protected under copyright of EVERLIGHT. Reproduction in any form is prohibited without obtaining EVERLIGHT's prior consent.
6. This product is not intended to be used for military,aircraft,automotive,medical.

EVERLIGHT