

### 16 PIN ULTRA SMALL SSOP AC INPUT PHOTOTRANSISTOR PHOTOCOUPLER ELQ3H4-G Series

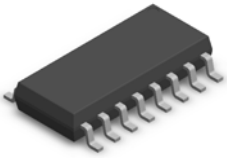

#### Features

- Halogens free
- AC input response
- Current transfer ratio (CTR: 20~400% at IF =1mA, VCE =5V)
- High isolation voltage between input and output (Viso=3750 V rms )
- Compact SSOP with a 2.0 mm profile
- Pb free and RoHS compliant.
- UL approved (No. E214129)
- VDE approved (No. 40028116)
- SEMKO approved
- NEMKO approved
- DEMKO approved
- FIMKO approved
- CQC approved

#### Description

The ELQ3H4-G is optically coupled isolator containing GaAs light emitting diodes and an NPN silicon phototransistors in a plastic SOP for high density applications. This package has shield effect to cut off ambient light.

#### Applications

- Programmable logic controllers
- Measuring instruments
- Hybrid IC

#### Schematic

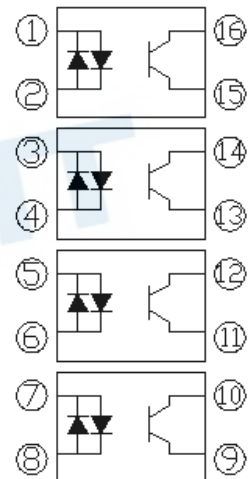

- ① ③ ⑤ ⑦ Anode/Cathode
- ② ④ ⑥ ⑧ Cathode/Anode
- ⑨ ⑪ ⑬ ⑮ Emitter
- ⑩ ⑫ ⑭ ⑯ Collector

**Absolute Maximum Ratings (T<sub>A</sub>=25°C)**

	Parameter	Symbol	Rating	Unit
Input	Forward current	I <sub>F</sub>	±60	mA
	Peak forward current (1us, pulse)	I <sub>FP</sub>	1	A
	Power dissipation	P <sub>D</sub>	70	mW/Ch
	Power Dissipation Derating		0.7	mW/°C
Output	Collector current	I <sub>C</sub>	50	mA
	Collector-Emitter voltage	V <sub>CEO</sub>	80	V
	Emitter-Collector voltage	V <sub>ECO</sub>	7	V
	Power dissipation	P <sub>C</sub>	150	mW /Ch
	Power Dissipation Derating		1.4	mW/°C
	Total power dissipation	P <sub>TOT</sub>	200	mW
	Isolation voltage *1	V <sub>ISO</sub>	3750	V rms
	Operating temperature	T <sub>OPR</sub>	-55 ~ +110	°C
	Storage temperature	T <sub>STG</sub>	-55 ~ +125	°C
	Soldering temperature *2	T <sub>SOL</sub>	260	°C

Notes:

\*1 AC for 1 minute, R.H.= 40 ~ 60% R.H. In this test, LED side pins shorted together, and detector side pins shorted together.

\*2 For 10 seconds

**Electrical Characteristics (T<sub>A</sub>=25°C unless specified otherwise)**

**Input**

Parameter	Symbol	Min.	Typ.	Max.	Unit	Condition
Forward voltage	V <sub>F</sub>	-	1.2	1.4	V	I <sub>F</sub> = ±20mA
Input Capacitance	C <sub>in</sub>	-	30	250	pF	V = 0, f = 1KHz

**Output**

Parameter	Symbol	Min	Typ.	Max.	Unit	Condition
Collector-Emitter dark current	I <sub>CEO</sub>	-	-	100	nA	V <sub>CE</sub> = 20V, I <sub>F</sub> = 0mA
Collector-Emitter breakdown voltage	BV <sub>CEO</sub>	80	-	-	V	I <sub>C</sub> = 0.1mA
Emitter-Collector breakdown voltage	BV <sub>ECO</sub>	7	-	-	V	I <sub>E</sub> = 0.1mA

**Transfer Characteristics (T<sub>A</sub>=-40 to 85°C unless specified otherwise)**

Parameter	Symbol	Min	Typ.	Max.	Unit	Condition
Current Transfer ratio	ELQ3H4	20	-	300	%	I <sub>F</sub> = ±1mA, V <sub>CE</sub> = 5V
	ELQ3H4B	100	-	400		
	ELQ3H4K	100	-	400		
	ELQ3H4Y	150	-	400		
CTR Ratio	CTR1/ CTR2	0.5	-	2.0		I <sub>F</sub> = ±1mA, V <sub>CE</sub> = 5V
Collector-Emitter saturation voltage	V <sub>CE(sat)</sub>	-	0.1	0.2	V	I <sub>F</sub> = ±20mA, I <sub>C</sub> = 1mA
Isolation resistance	R <sub>IO</sub>	5×10 <sup>10</sup>	-	-	Ω	V <sub>IO</sub> = 500Vdc, 40~60% R.H.
Floating capacitance	C <sub>IO</sub>	-	0.3	1.0	pF	V <sub>IO</sub> = 0, f = 1MHz
Rise time	t <sub>r</sub>	-	5	18	μs	V <sub>CE</sub> = 2V, I <sub>C</sub> = 2mA, R <sub>L</sub> = 100Ω
Fall time	t <sub>f</sub>	-	3	18	μs	

Typical Electro-Optical Characteristics Curves

Figure 1. Forward Current vs Forward Voltage

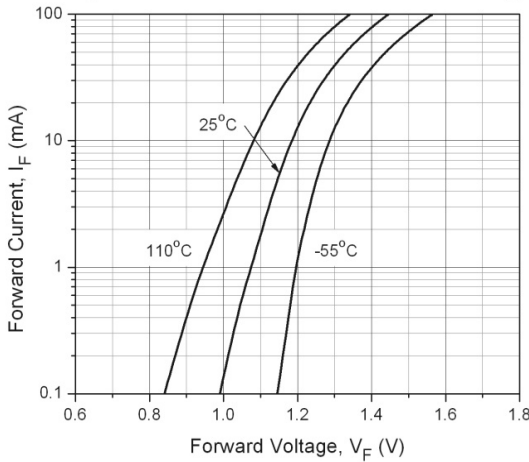

Figure 2. Normalized Collector Current vs Forward Current

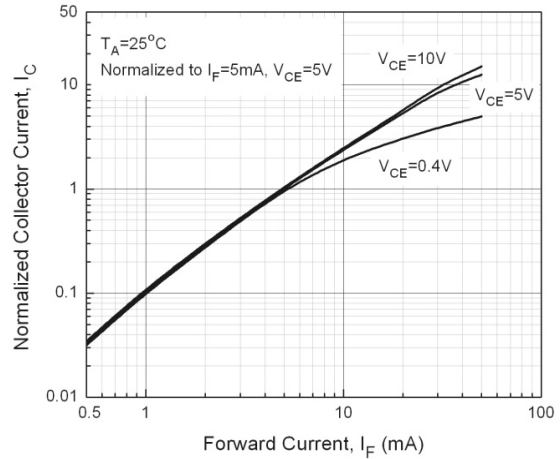

Figure 3. Normalized Current Transfer Ratio vs Forward Current

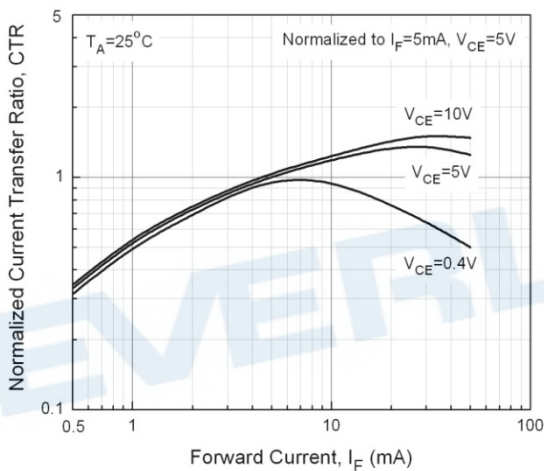

Figure 4. Normalized Collector Current vs Ambient Temperature

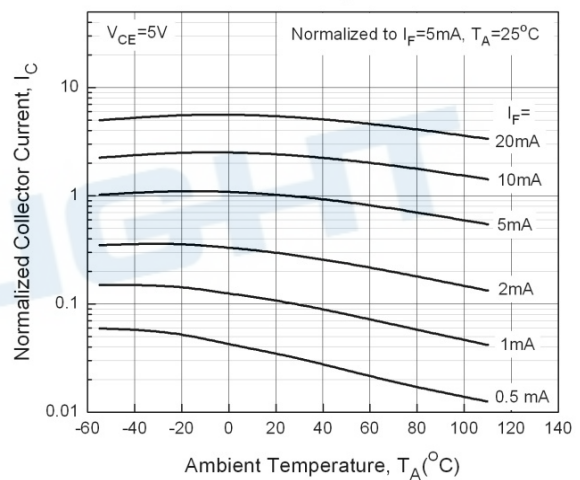

Figure 5. Normalized Current Transfer Ratio vs Ambient Temperature

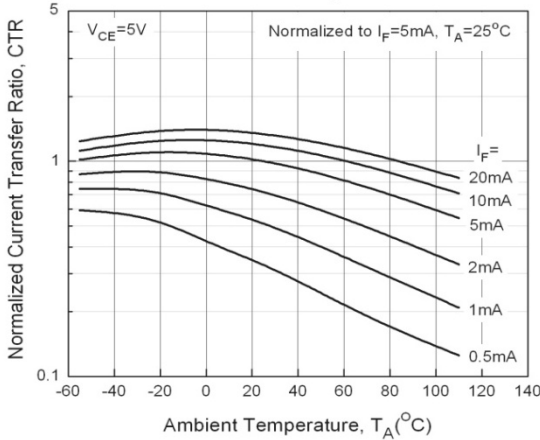

Figure 6. Collector Current vs Collector-Emitter Voltage

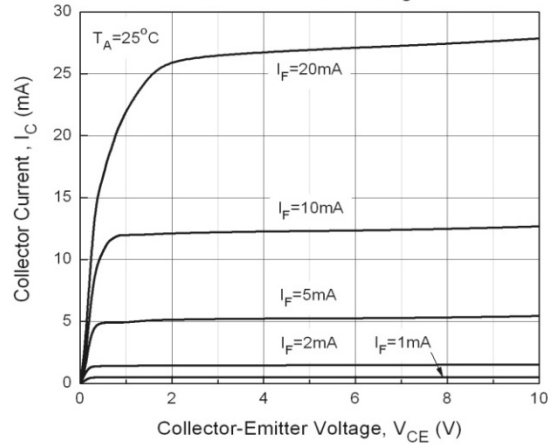

Figure 7. Collector Current vs Collector-Emitter Voltage

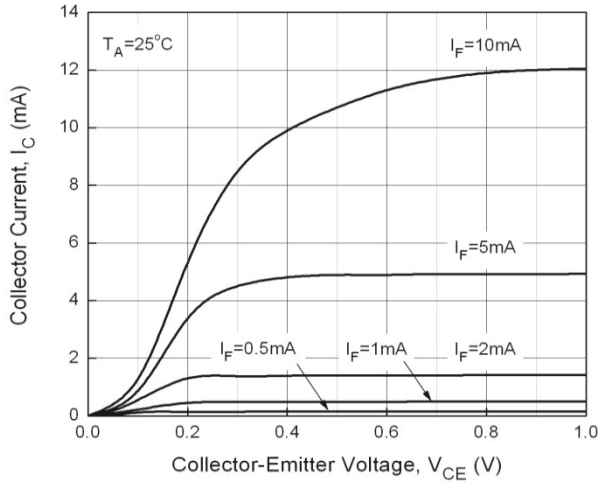

Figure 8. Collector Dark Current vs Ambient Temperature

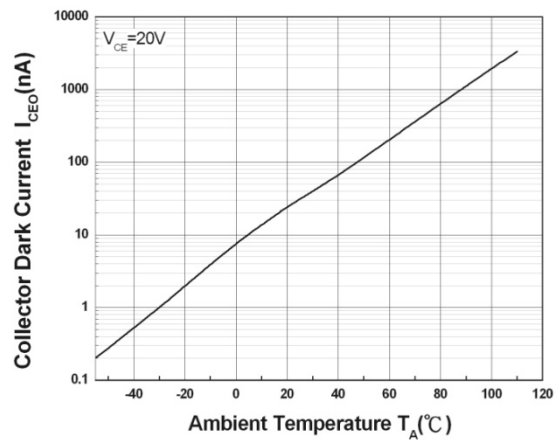

Figure 9. Collector-Emitter Saturation Voltage vs Ambient Temperature

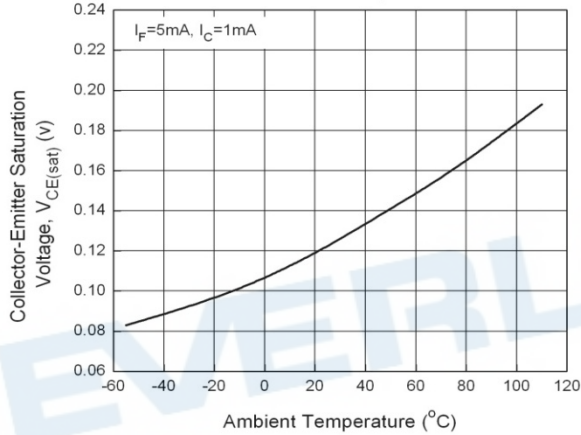

Figure 10. Switching Time vs Load Resistance

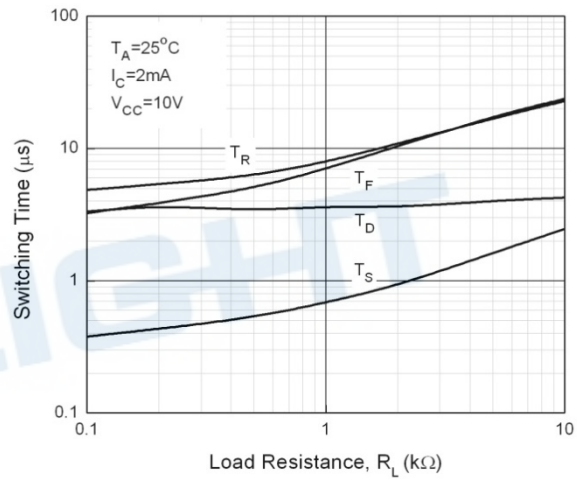
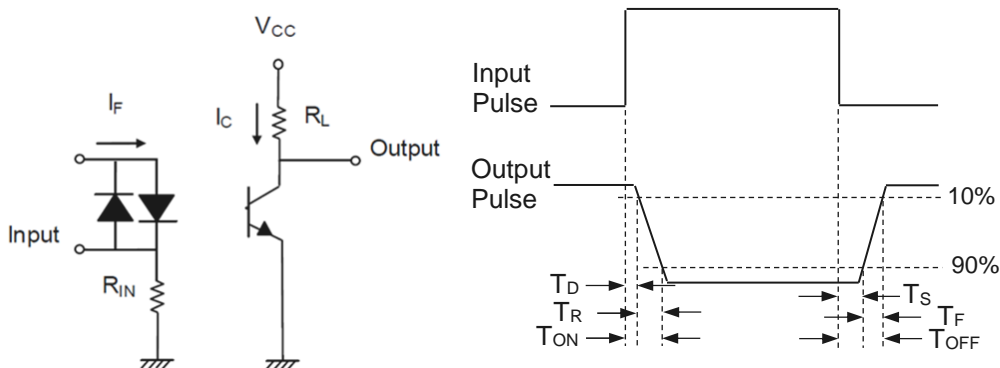

Figure 11. Switching Time Test Circuit & Waveform



## Order Information

### Part Number

**ELQ3H4(R)(Z)-VG**

### Note

R = CTR rank(B, K, Y or none)  
Z = Tape and reel option (TA or none)  
V = VDE (optional)  
G = Halogens free

Option	Description	Packing quantity
None	Tube option of ELQ3H4	40 units per tube
(TA)	Tape & reel option of ELQ3H4	1000 units per reel

EVERLIGHT

### Package Dimension

(Dimensions in mm)

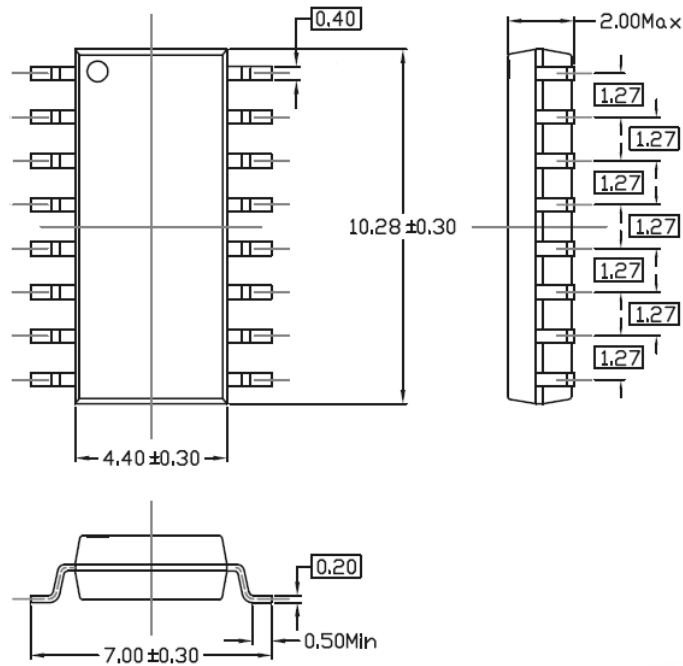

### Recommended pad layout for surface mount leadform

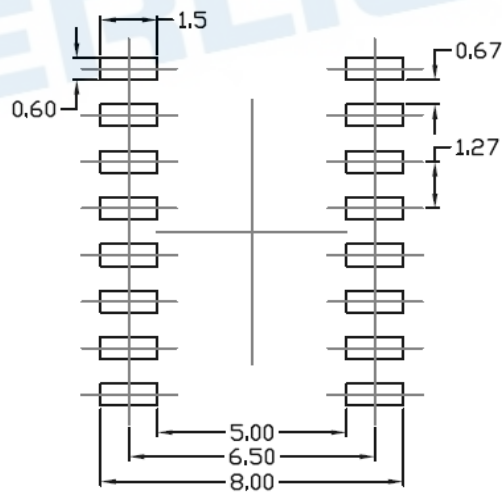

### Device Marking



### Notes

EL	denotes EVERLIGHT
Q3H4	denotes Device Number
R	denotes CTR rank
Y	denotes 1 digit Year code
WW	denotes 2 digit Week code
V	denotes VDE (optional)

EVERLIGHT

Tape & Reel Packing Specifications

ELQ3H4

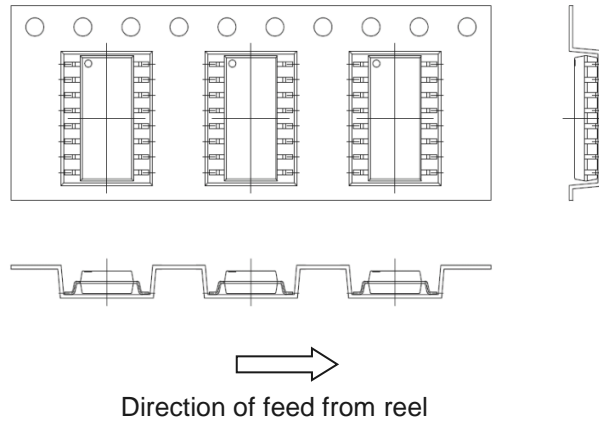

Tape dimension

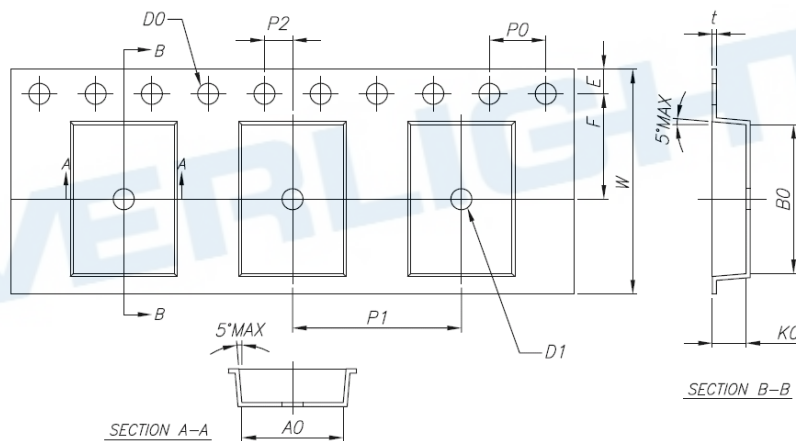

Dimension No.	<b>A0</b>	<b>B0</b>	<b>D0</b>	<b>D1</b>	<b>E</b>	<b>F</b>
Dimension (mm)	7.2±0.1	10.6±0.1	1.5+0.1 -0	1.5+0.1 -0	1.75±0.1	7.5±0.1
Dimension No.	<b>P0</b>	<b>P1</b>	<b>P2</b>	<b>t</b>	<b>W</b>	<b>K0</b>
Dimension (mm)	4.0±0.1	12.0±0.1	2.0±0.1	0.3±0.05	16.0±0.3	2.4±0.1

**Precautions for Use**

1. Soldering Condition

1.1 (A) Maximum Body Case Temperature Profile for evaluation of Reflow Profile

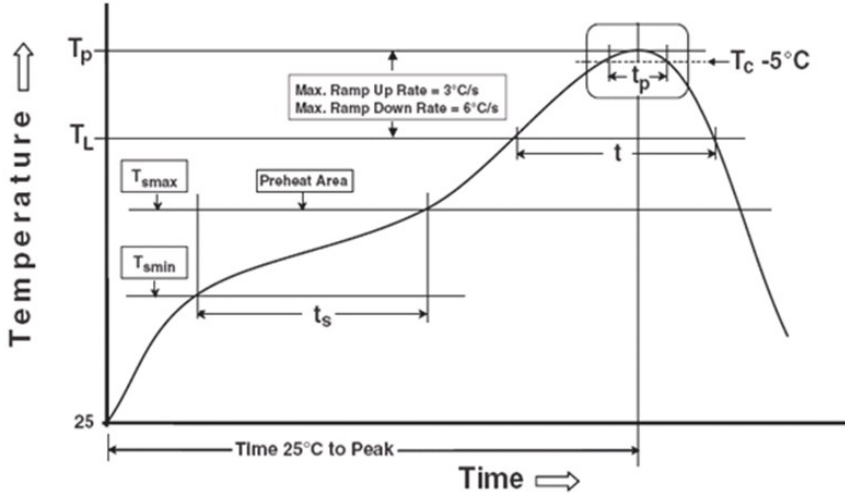

Note:

Reference: IPC/JEDEC J-STD-020D

**Preheat**

Temperature min ( $T_{smin}$ )	150 °C
Temperature max ( $T_{smax}$ )	200°C
Time ( $T_{smin}$ to $T_{smax}$ ) ( $t_s$ )	60-120 seconds
Average ramp-up rate ( $T_{smax}$ to $T_p$ )	3 °C/second max

**Other**

Liquidus Temperature ( $T_L$ )	217 °C
Time above Liquidus Temperature ( $t_L$ )	60-100 sec
Peak Temperature ( $T_P$ )	260°C
Time within 5 °C of Actual Peak Temperature: $T_P - 5^\circ\text{C}$	30 s
Ramp- Down Rate from Peak Temperature	6°C /second max.
Time 25°C to peak temperature	8 minutes max.
Reflow times	3 times

## Disclaimer

1. Above specification may be changed without notice. EVERLIGHT will reserve authority on material change for above specification.
2. The graphs shown in this datasheet are representing typical data only and do not show guaranteed values.
3. When using this product, please observe the absolute maximum ratings and the instructions for use outlined in these specification sheets. EVERLIGHT assumes no responsibility for any damage resulting from use of the product which does not comply with the absolute maximum ratings and the instructions included in these specification sheets.
4. These specification sheets include materials protected under copyright of EVERLIGHT. Reproduction in any form is prohibited without the specific consent of EVERLIGHT.
5. This product is not intended to be used for military, aircraft, automotive, medical, life sustaining or life saving applications or any other application which can result in human injury or death. Please contact authorized Everlight sales agent for special application request.
6. Statements regarding the suitability of products for certain types of applications are based on Everlight's knowledge of typical requirements that are often placed on Everlight products in generic applications. Such statements are not binding statements about the suitability of products for a particular application. It is the customer's responsibility to validate that a particular product with the properties described in the product specification is suitable for use in a particular application. Parameters provided in datasheets and/or specifications may vary in different applications and performance may vary over time. All operating parameters, including typical parameters, must be validated for each customer application by the customer's technical experts. Product specifications do not expand or otherwise modify Everlight's terms and conditions of purchase, including but not limited to the warranty expressed therein.

EVERLIGHT