

5 PIN LONG CREEPAGE SOP PHOTOTRANSISTOR PHOTOCOUPLER EL111X-G Series

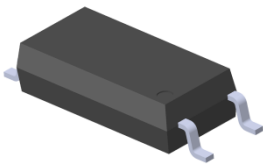

Features:

- Compliance Halogen Free
(Br <900 ppm ,Cl <900 ppm , Br+Cl < 1500 ppm)
- Current transfer ratio
(CTR: 50~600% at $I_F = 5\text{mA}$, $V_{CE} = 5\text{V}$)
(CTR: 63~320% at $I_F = 10\text{mA}$, $V_{CE} = 5\text{V}$)
- High isolation voltage between input and output ($V_{iso} = 5000\text{ V rms}$)
- Compact 5 Pin SOP with a 2.0 mm profile
- Compliance with EU REACH
- 8mm long creepage distance
- The product itself will remain within RoHS compliant version
- UL and cUL approved(No. E214129)
- VDE approved (No. 40028391)
- SEMKO approved
- NEMKO approved
- DEMKO approved
- FIMKO approved
- CQC approved

Description

The EL111X-G series devices consist of an infrared emitting diode, optically coupled to a phototransistor detector. Compound use free halogens and Sb_2O_3 . They are packaged in a 5-pin SOP package

Applications

- Programmable controllers
- System appliances, measuring instruments
- Telecommunication equipments
- Home appliances, such as fan heaters, etc.
- Signal transmission between circuits of different potentials and impedances

Schematic

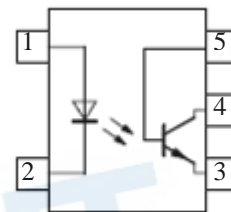

Pin Configuration

1. Anode
2. Cathode
3. Emitter
4. Collector
5. Base

Absolute Maximum Ratings (Ta=25°C)

| | Parameter | Symbol | Rating | Unit |
|--------|-----------------------------------|------------------|------------|-------|
| Input | Forward current | I _F | 60 | mA |
| | Peak forward current (1us, pulse) | I _{FP} | 1.5 | A |
| | Reverse voltage | V _R | 6 | V |
| | Power dissipation | P _D | 100 | mW |
| | Power dissipation | P _C | 150 | mW |
| Output | Collector current | I _C | 50 | mA |
| | Collector-Emitter voltage | V _{CEO} | 80 | V |
| | Emitter-Collector voltage | V _{ECO} | 7 | V |
| | Total Power Dissipation | P _{TOT} | 250 | mW |
| | Isolation Voltage*1 | V _{ISO} | 5000 | V rms |
| | Operating Temperature | T _{OPR} | -55 to 110 | °C |
| | Storage Temperature | T _{STG} | -55 to 125 | °C |
| | Soldering Temperature*2 | T _{SOL} | 260 | °C |

Notes:

*1 AC for 1 minute, R.H.= 40 ~ 60% R.H. In this test, pins 1, 2 are shorted together, and pins 3, 4 & 5 are shorted together.

*2 For 10 seconds

Electro-Optical Characteristics (Ta=25°C unless specified otherwise)

Input

| Parameter | Symbol | Min. | Typ. | Max. | Unit | Condition |
|-------------------|-----------------|------|------|------|------|-----------------------|
| Forward Voltage | V _F | - | - | 1.5 | V | I _F = 50mA |
| Reverse current | I _R | - | - | 10 | μA | V _R = 6V |
| Input capacitance | C _{in} | - | 50 | - | pF | V = 0, f = 1kHz |

Output

| Parameter | Symbol | Min | Typ. | Max. | Unit | Condition |
|-------------------------------------|-------------------|-----|------|------|------|---|
| Collector-Emitter dark current | I _{CEO} | - | - | 100 | nA | V _{CE} = 20V, I _F = 0mA |
| Collector-Emitter breakdown voltage | BV _{CEO} | 80 | - | - | V | I _C = 0.1mA |
| Emitter-Collector breakdown voltage | BV _{ECO} | 7 | - | - | V | I _E = 0.1mA |

Transfer Characteristics

| Parameter | Symbol | Min | Typ. | Max. | Unit | Condition | | |
|--------------------------------------|----------------------|--------------------|------|------|--|---|-----|---|
| Current Transfer ratio | EL1110 | 50 | - | 600 | | I _F = 5mA, V _{CE} = 5V | | |
| | EL1116 | 100 | - | 300 | | | | |
| | EL1117 | CTR | 80 | - | | | 160 | % |
| | EL1118 | 130 | - | 260 | | | | |
| | EL1119 | 200 | - | 400 | | | | |
| | EL1112 | 63 | - | 125 | | I _F = 10mA, V _{CE} = 5V | | |
| | EL1113 | 100 | - | 200 | | | | |
| | EL1114 | CTR | 160 | - | | | 320 | % |
| | EL1112 | 22 | - | - | | | | |
| | EL1113 | 34 | - | - | | | | |
| EL1114 | 56 | - | - | | I _F = 1mA, V _{CE} = 5V | | | |
| Collector-Emitter saturation voltage | V _{CE(sat)} | - | - | 0.4 | V | I _F = 10mA, I _C = 1mA | | |
| Isolation resistance | R _{IO} | 5×10 ¹⁰ | - | - | Ω | V _{IO} = 500Vdc, 40~60% R.H. | | |
| Floating capacitance | C _{IO} | - | - | 1.0 | pF | V _{IO} = 0, f = 1MHz | | |

Transfer Characteristics

| Parameter | Symbol | Min | Typ. | Max. | Unit | Condition |
|---------------|----------------|-----|------|------|------|--|
| Turn on time | Ton | - | 4 | - | μs | V _{CE} = 5V, I _C = 5mA, R _L = 100Ω |
| Turn off time | Toff | - | 3 | - | | |
| Rise time | t _r | - | 2 | 18 | μs | V _{CE} = 5V, I _C = 5mA, R _L = 100Ω |
| Fall time | t _f | - | 3 | 18 | | |

* Typical values at T_a = 25°C

EVERLIGHT

Typical Electro-Optical Characteristics Curves

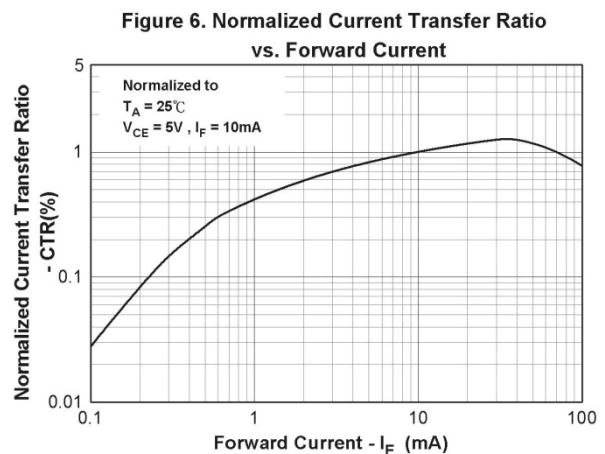
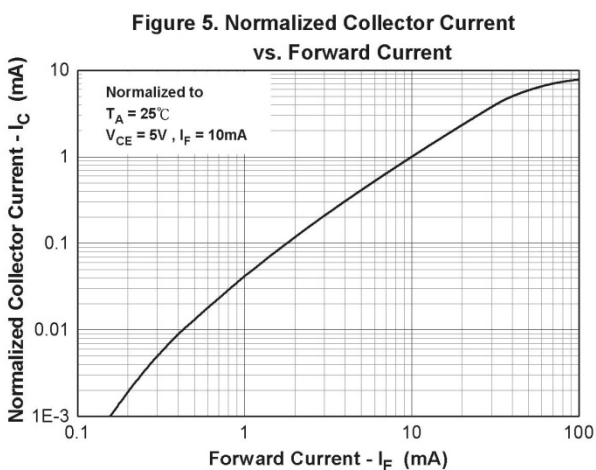
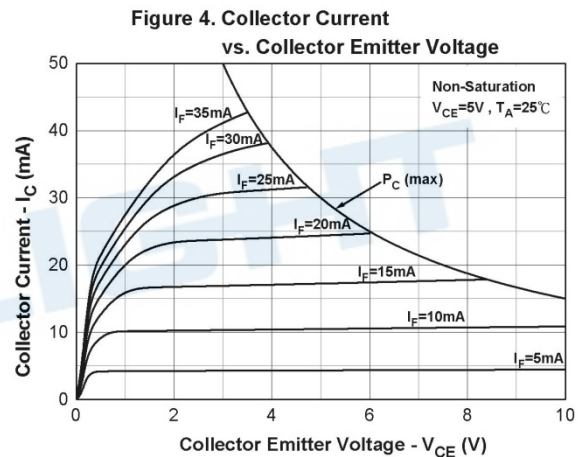
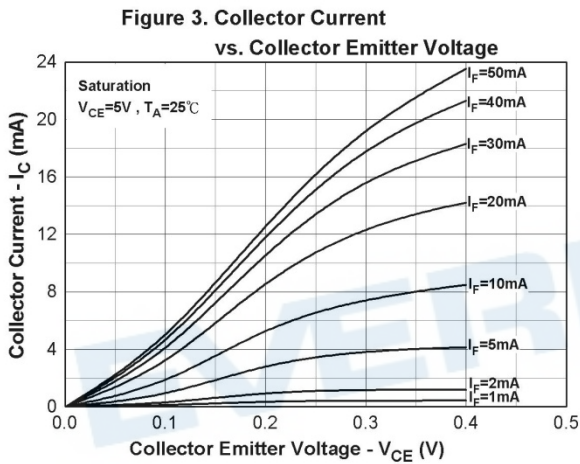
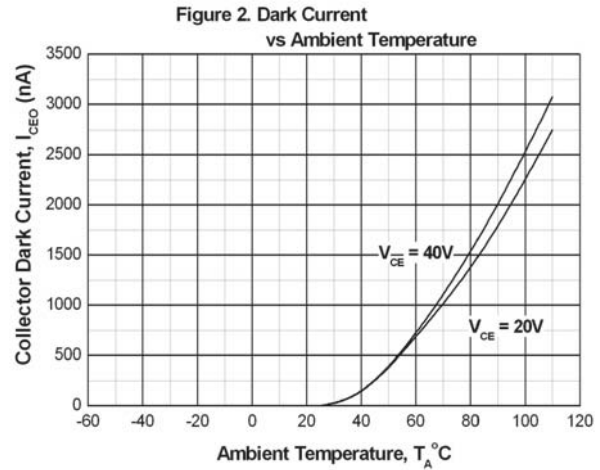
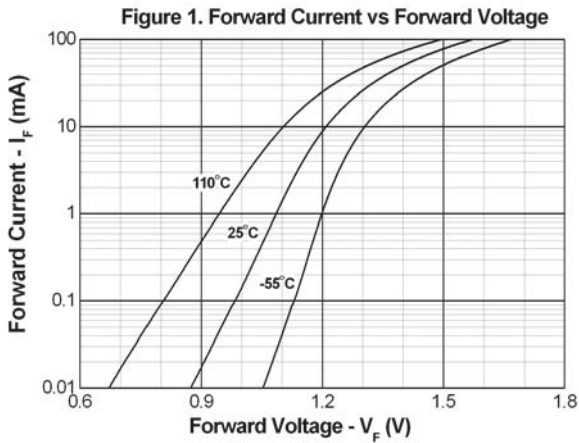

Figure 7. Normalized Current Transfer Ratio vs. Ambient Temperature

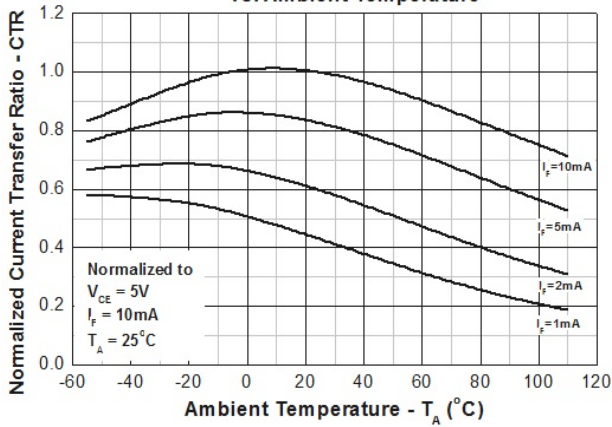

Figure 8. Normalized Current Transfer Ratio vs. Ambient Temperature

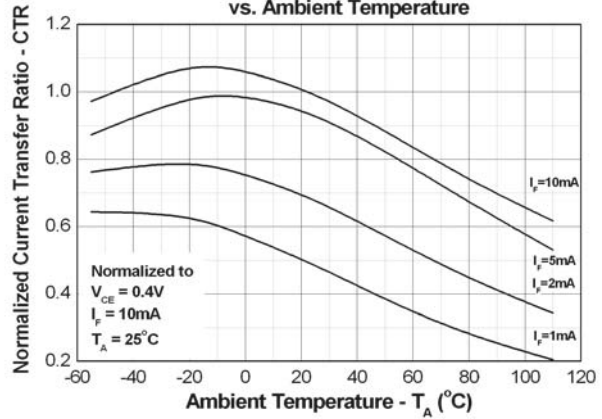

Figure 9. Turn on/off Time vs. Collector Current

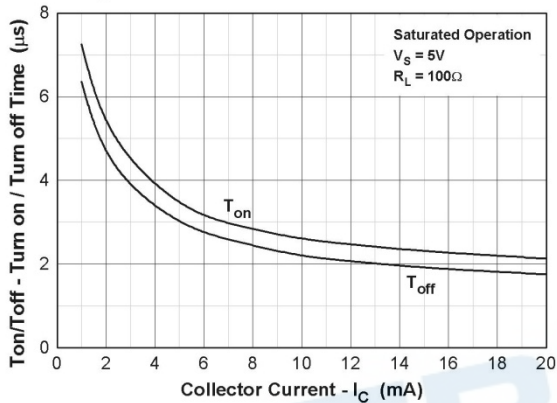

Figure 10. Turn on/off Time vs. Forward Current

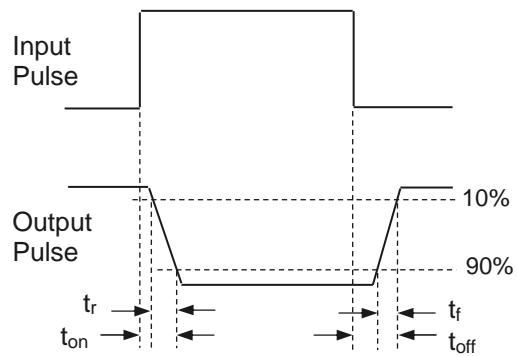
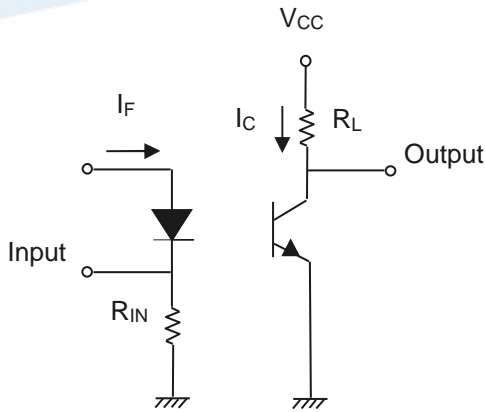
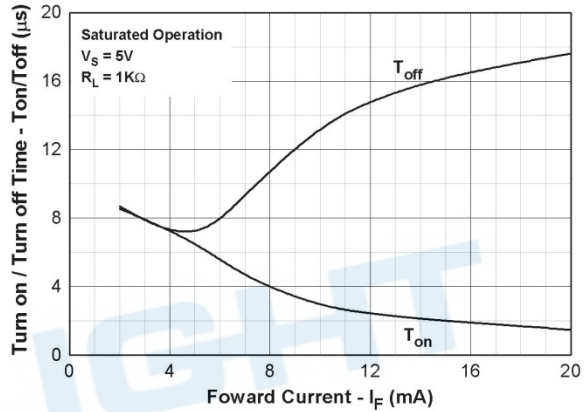

Figure 11. Switching Time Test Circuit & Waveforms

Order Information

Part Number

EL111X(Y)-VG

Note

EL111 = Part No.
X = CTR Rank (0, 2, 3, 4, 6, 7, 8 or 9)
Y = Tape and reel option (TA, TB or none).
V = VDE safety (optional)
G = Halogens free

| Option | Description | Packing quantity |
|--------|-----------------------------|---------------------|
| None | Standard SMD option | 100 units per tube |
| -V | Standard SMD option + VDE | 100 units per tube |
| (TA) | TA Tape & reel option | 3000 units per reel |
| (TB) | TB Tape & reel option | 3000 units per reel |
| (TA)-V | TA Tape & reel option + VDE | 3000 units per reel |
| (TB)-V | TB Tape & reel option + VDE | 3000 units per reel |

Package Dimension (Dimensions in mm)

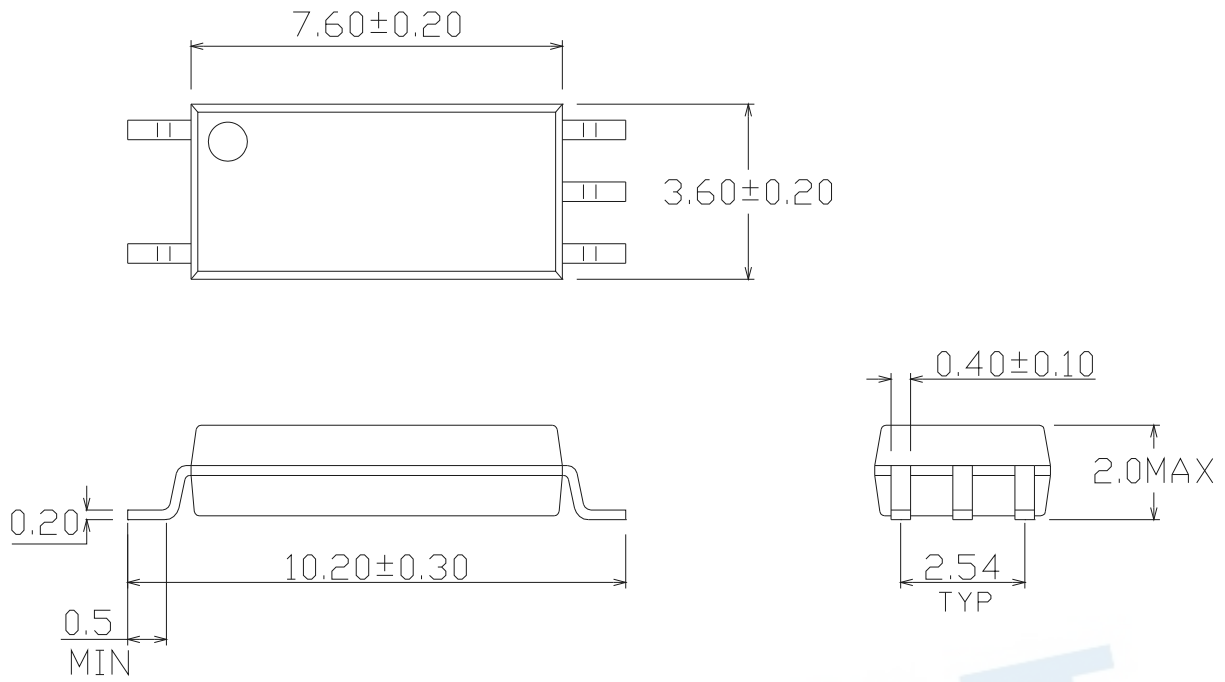

Recommended pad layout for surface mount leadform

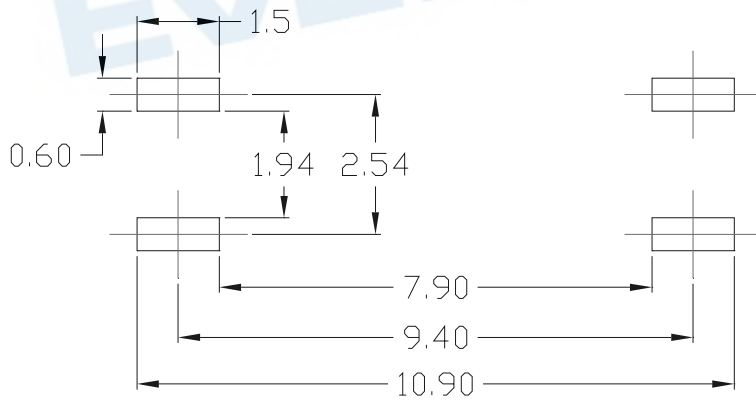

Device Marking

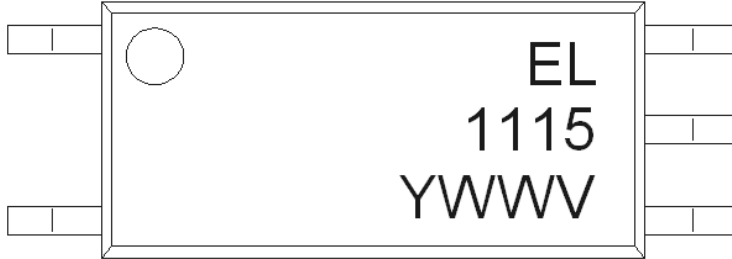

Notes

| | |
|------|---------------------------|
| EL | denotes Everlight |
| 1115 | denotes Device Number |
| Y | denotes 1 digit Year code |
| WW | denotes 2 digit Week code |
| V | denotes VDE (optional) |

EVERLIGHT

Tape & Reel Packing Specifications

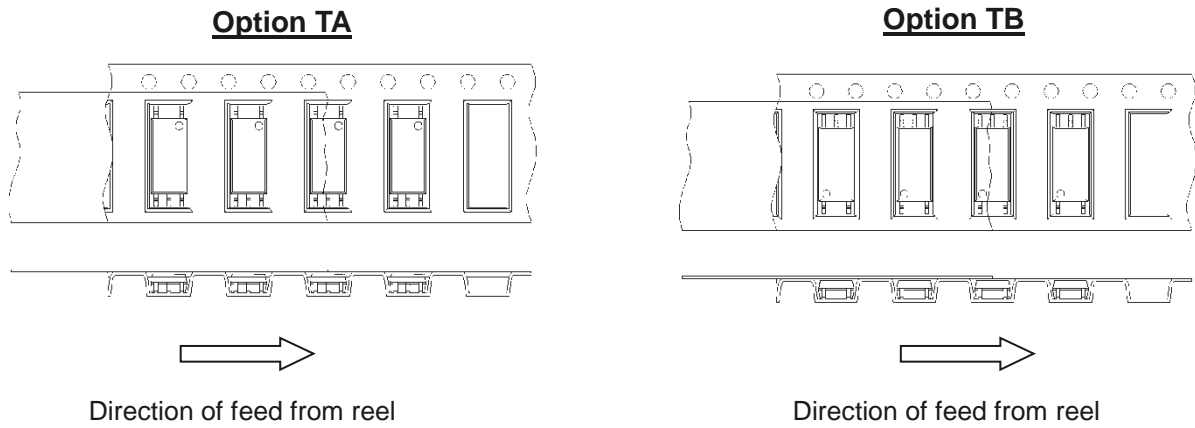

Tape dimensions

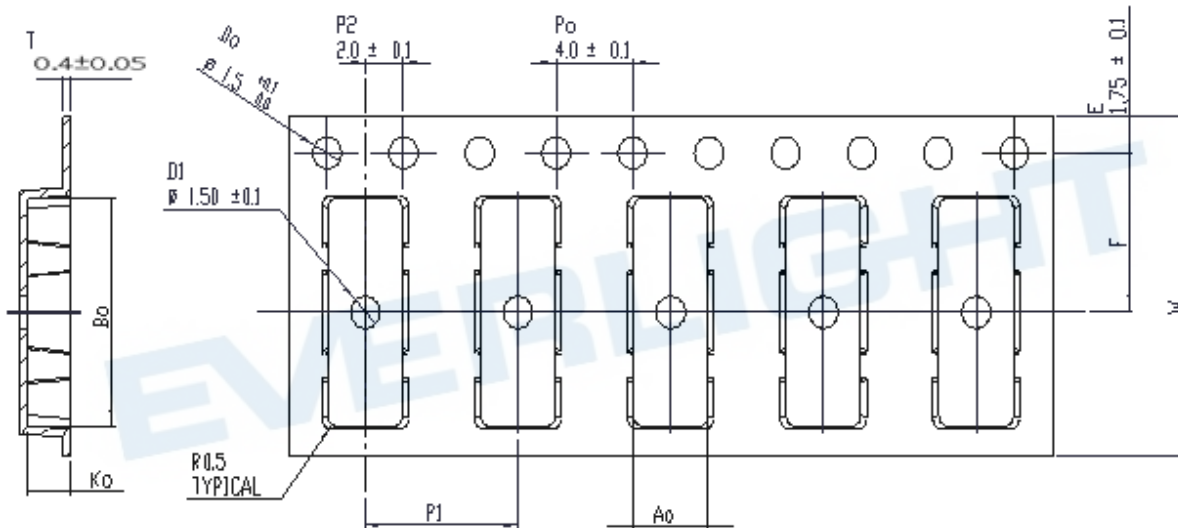

| | | | | | | |
|----------------|----------------|------------------|----------------|----------------|-----------------|-----------------|
| Dimension No. | Ao | Bo | Do | D1 | E | F |
| Dimension (mm) | 3.9 ± 0.10 | 10.75 ± 0.10 | $1.5 + 0.1/-0$ | 1.5 ± 0.10 | 1.75 ± 0.10 | 7.5 ± 0.10 |
| Dimension No. | Po | P1 | P2 | T | W | Ko |
| Dimension (mm) | 4.0 ± 0.10 | 8.0 ± 0.10 | 2.0 ± 0.10 | 0.4 ± 0.05 | 16.0 ± 0.30 | 2.25 ± 0.10 |

Precautions for Use

1. Soldering Condition

1.1 (A) Maximum Body Case Temperature Profile for evaluation of Reflow Profile

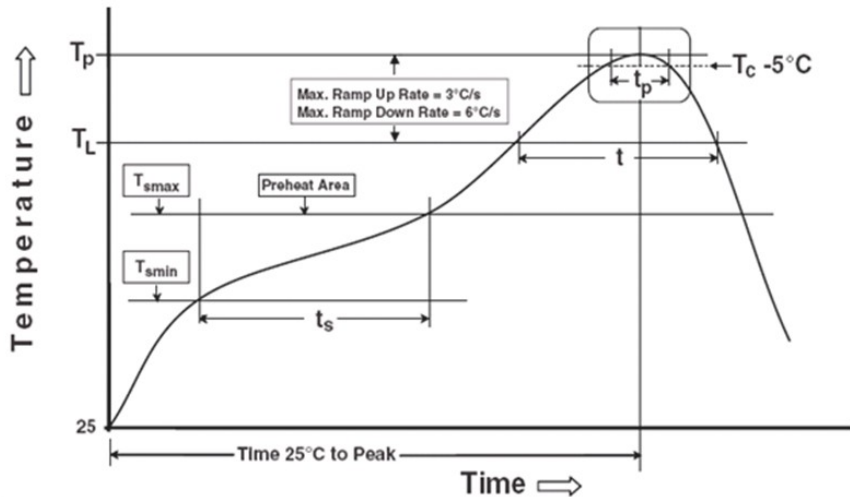

Note:

Reference: IPC/JEDEC J-STD-020D

Preheat

| | |
|--|-----------------|
| Temperature min (T_{smin}) | 150 °C |
| Temperature max (T_{smax}) | 200°C |
| Time (T_{smin} to T_{smax}) (t_s) | 60-120 seconds |
| Average ramp-up rate (T_{smax} to T_p) | 3 °C/second max |

Other

| | |
|--|------------------|
| Liquidus Temperature (T_L) | 217 °C |
| Time above Liquidus Temperature (t_L) | 60-100 sec |
| Peak Temperature (T_p) | 260°C |
| Time within 5 °C of Actual Peak Temperature: $T_p - 5^\circ\text{C}$ | 30 s |
| Ramp- Down Rate from Peak Temperature | 6°C /second max. |
| Time 25°C to peak temperature | 8 minutes max. |
| Reflow times | 3 times |

DISCLAIMER

1. Above specification may be changed without notice. EVERLIGHT will reserve authority on material change for above specification.
2. The graphs shown in this datasheet are representing typical data only and do not show guaranteed values.
3. When using this product, please observe the absolute maximum ratings and the instructions for use outlined in these specification sheets. EVERLIGHT assumes no responsibility for any damage resulting from use of the product which does not comply with the absolute maximum ratings and the instructions included in these specification sheets.
4. These specification sheets include materials protected under copyright of EVERLIGHT. Reproduction in any form is prohibited without the specific consent of EVERLIGHT.
5. This product is not intended to be used for military, aircraft, automotive, medical, life sustaining or life saving applications or any other application which can result in human injury or death. Please contact authorized Everlight sales agent for special application request.
6. Statements regarding the suitability of products for certain types of applications are based on Everlight's knowledge of typical requirements that are often placed on Everlight products in generic applications. Such statements are not binding statements about the suitability of products for a particular application. It is the customer's responsibility to validate that a particular product with the properties described in the product specification is suitable for use in a particular application. Parameters provided in datasheets and/or specifications may vary in different applications and performance may vary over time. All operating parameters, including typical parameters, must be validated for each customer application by the customer's technical experts. Product specifications do not expand or otherwise modify Everlight's terms and conditions of purchase, including but not limited to the warranty expressed therein..