

SMD ■ C EAPL3020AA0



Features

- Top view red LEDs
- White SMT package.
- Lead frame package with individual 2 pins.
- Wide viewing angle.
- Soldering methods: IR reflow soldering
- Pb-free.
- The product itself will remain within RoHS compliant version.
- Compliance with EU REACH.
- Compliance Halogen Free .(Br <900 ppm ,Cl <900 ppm , Br+Cl < 1500 ppm).

Description

- The 45-21 series is available in soft orange, green, blue and yellow. Due to the package design, the LED has wide viewing angle and optimized light coupling by inter reflector. This feature makes the device ideal for light pipe application. The low current requirement makes this device ideal for portable equipment or any other application where power is at a premium.

Applications

- Telecommunication: indicator and backlighting in telephone and fax
- Flat backlight for LCD, switch and symbol
- Light pipe application
- General use

Device Selection Guide

Chip Materials	Emitted Color	Resin Color
AlGaInP	Brilliant Orange	Water Clear

Absolute Maximum Ratings (Ta=25°C)

Parameter	Symbol	Rating	Unit
Reverse Voltage	V_R	5	V
Forward Current	I_F	25	mA
Peak Forward Current (Duty 1/10 @1KHz)	I_{FP}	60	mA
Power Dissipation	P_d	60	mW
Operating Temperature	T_{opr}	-40 ~ +85	°C
Storage Temperature	T_{stg}	-40 ~ +90	°C
Electrostatic Discharge	ESD_{HBM}	2000	V
Soldering Temperature	T_{sol}	Reflow Soldering : 260 °C for 10 sec. Hand Soldering : 350 °C for 3 sec.	

Electro-Optical Characteristics (Ta=25°C)

Parameter	Symbol	Min.	Typ.	Max.	Unit	Condition
Luminous Intensity	I_v	90	----	225	mcd	$I_F=20mA$
Viewing Angle	$2\theta_{1/2}$	-----	120	-----	deg	$I_F=20mA$
Peak Wavelength	λ_p	-----	611	-----	nm	$I_F=20mA$
Dominant Wavelength	λ_d	600.5	-----	612.5	nm	$I_F=20mA$
Spectrum Radiation Bandwidth	$\Delta \lambda$	-----	17	-----	nm	$I_F=20mA$
Forward Voltage	V_F	1.75	-----	2.35	V	$I_F=20mA$
Reverse Current	I_R	-----	-----	10	μA	$V_R=5V$

Notes:

1. Tolerance of Luminous Intensity: $\pm 11\%$
2. Tolerance of Dominant Wavelength: $\pm 1nm$
3. Tolerance of Forward Voltage: $\pm 0.1V$

Bin Range of Luminous Intensity

Bin Code	Min.	Max.	Unit	Conduction
Q2	90	112	mcd	$I_F=20\text{mA}$
R1	112	140		
R2	140	180		
S1	180	225		

Bin Range of Dominant Wavelength

Group	Bin Code	Min.	Max.	Unit	Condition
A	D8	600.5	603.5	nm	$I_F =20\text{mA}$
	D9	603.5	606.5		
	D10	606.5	609.5		
	D11	609.5	612.5		

Bin Range of Forward Voltage

Group	Group	Min.	Max.	Unit	Condition
B	0	1.75	1.95	V	$I_F=20\text{mA}$
	1	1.95	2.15		
	2	2.15	2.35		

Notes:

1. Tolerance of Luminous Intensity: $\pm 11\%$
2. Tolerance of Dominant Wavelength: $\pm 1\text{nm}$
3. Tolerance of Forward Voltage: $\pm 0.1\text{V}$

Typical Electro-Optical Characteristics Curves

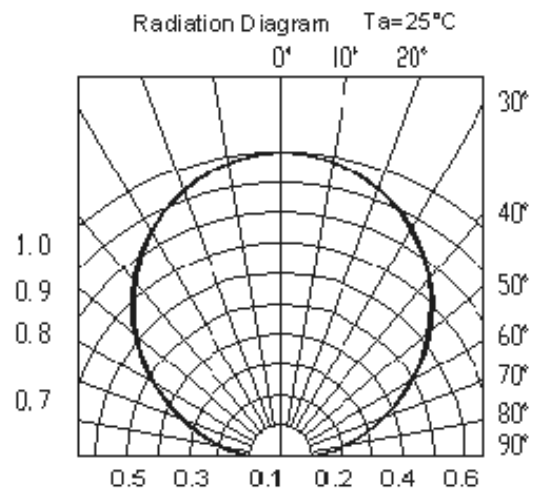
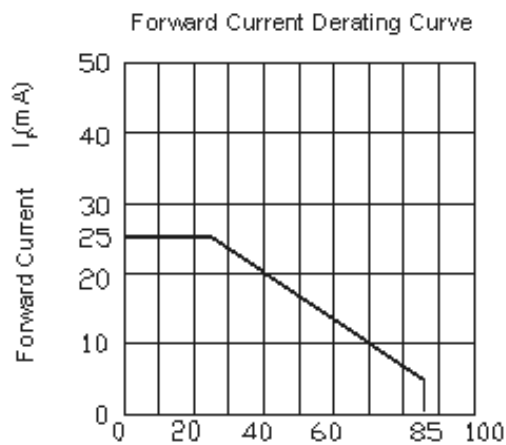
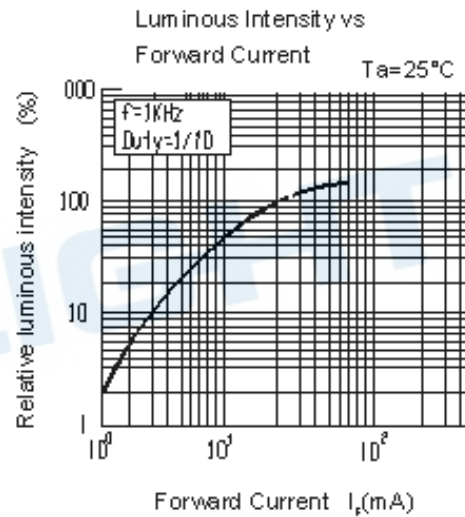
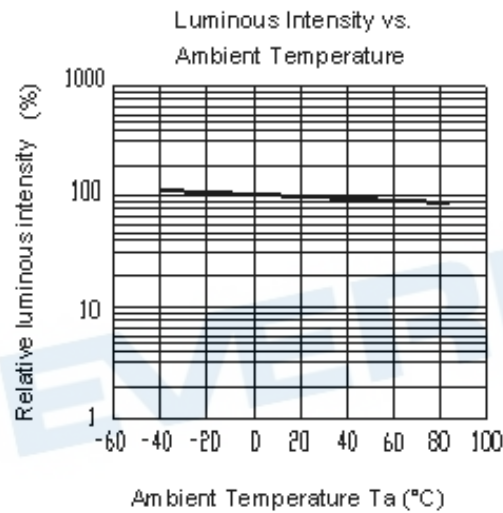
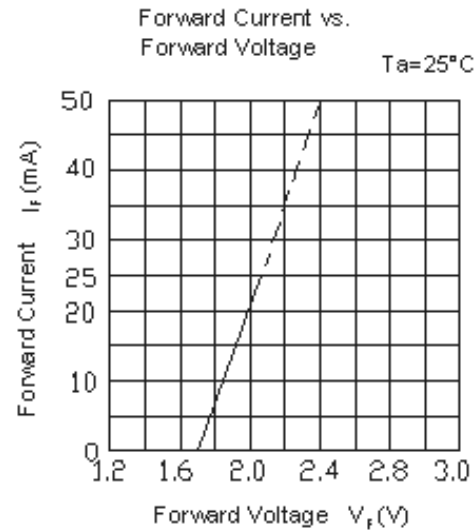
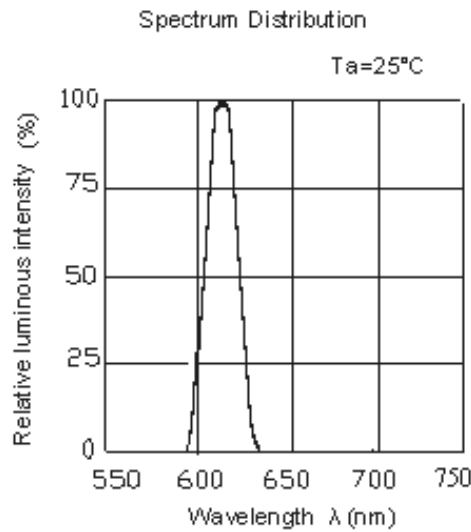

Package Outline Dimensions

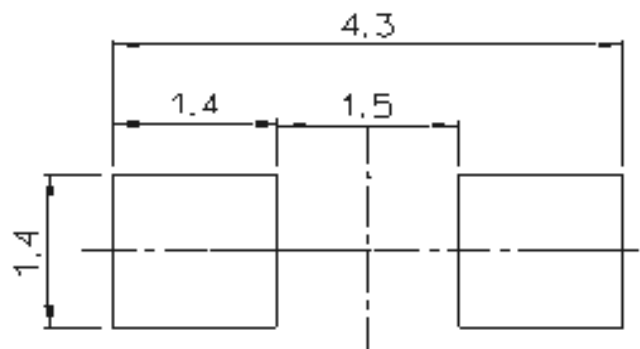
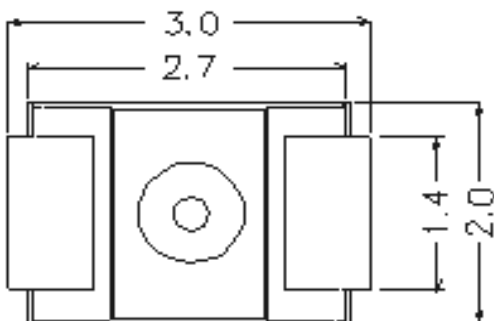
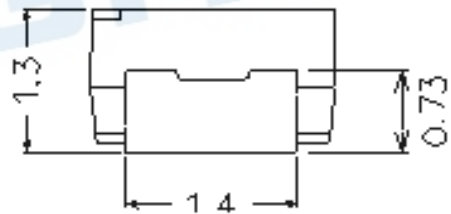
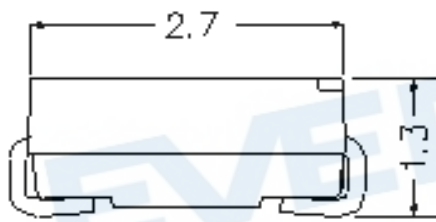
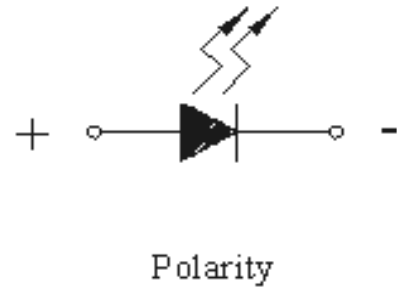
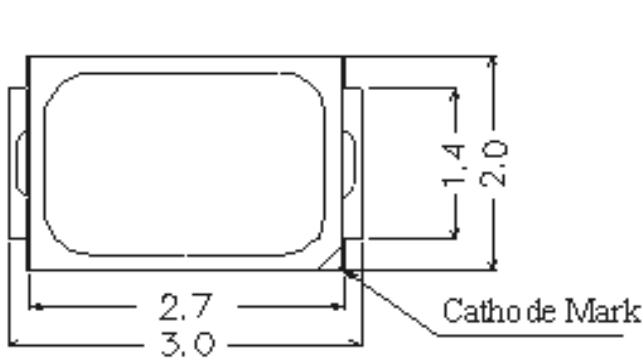

Recommended soldering pad design

Note: The tolerances unless mentioned are ± 0.1 , unit=mm.

Moisture Resistant Packing Materials

Label Explanation

- CAT: Luminous Intensity Rank
- HUE: Dom. Wavelength Rank
- REF: Forward Voltage Rank

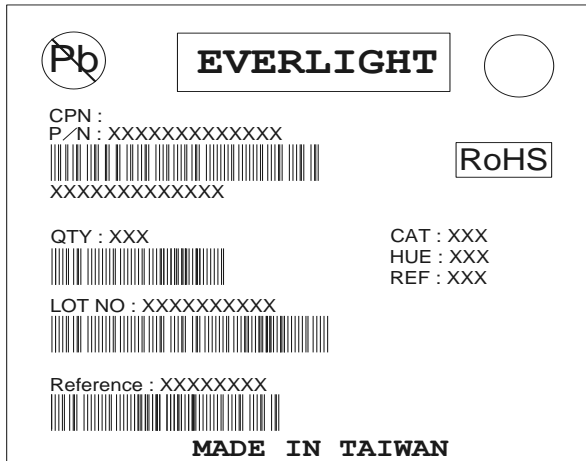

Reel & Carrier Tape Dimensions

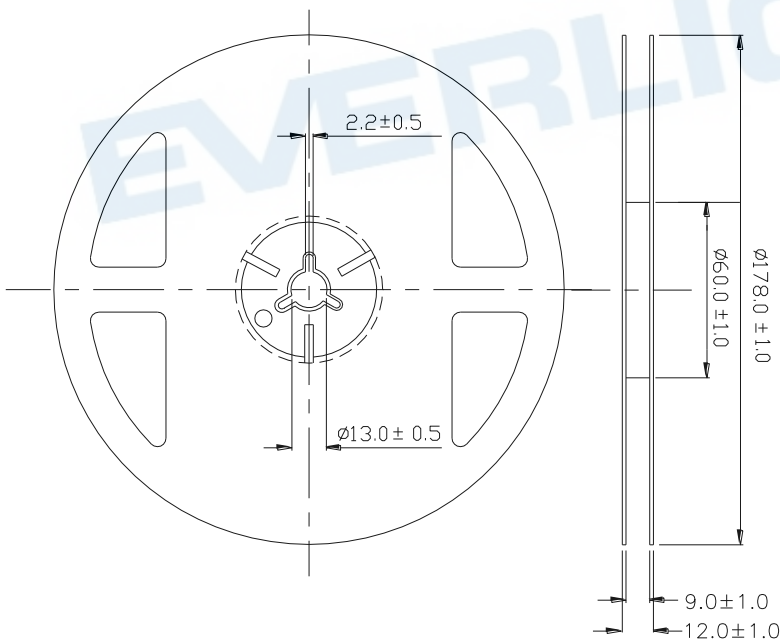

Note: The tolerances unless mentioned are ± 0.1 , unit=mm

Loaded quantity 250/500/1000/2000 PCS per reel

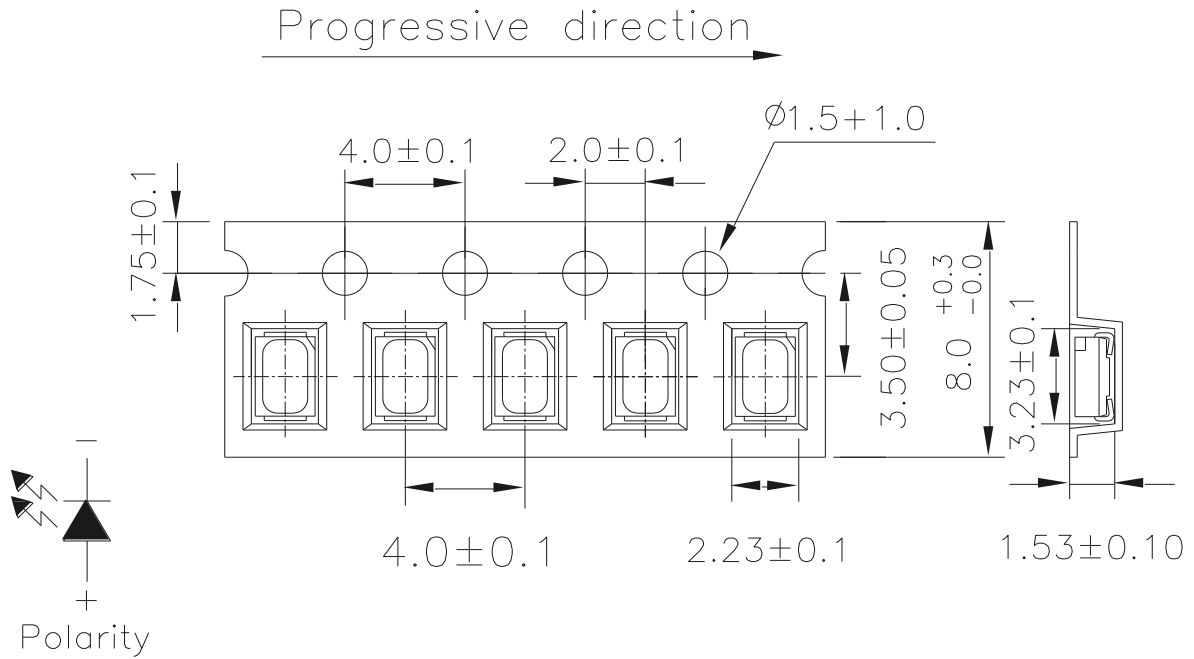

Note: The tolerances unless mentioned are ± 0.1 , unit=mm.

Moisture Resistant Packaging

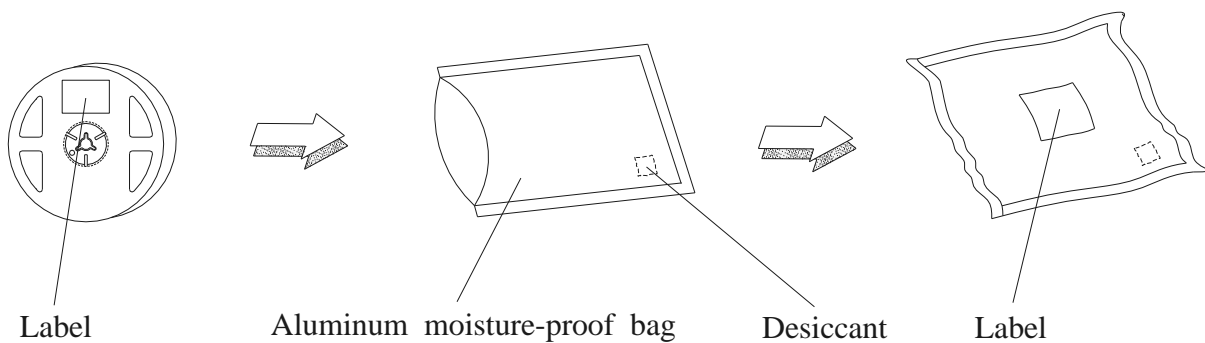

Reliability Test Items and Conditions

The reliability of products shall be satisfied with items listed below.
Confidence level : 90%
LTPD : 10%

No.	Items	Test Condition	Test Hours/Cycles	Sample Size	Ac/Re
1	Reflow Soldering	Temp. : 260°C/10sec.	6 Min.	22 PCS.	0/1
2	Thermal Shock	H : +100°C 5min ∫ 10 sec L : -10°C 5min	300 Cycles	22 PCS.	0/1
3	Temperature Cycle	H : +100°C 15min ∫ 5 min L : -40°C 15min	300 Cycles	22 PCS.	0/1
4	High Temperature/High Humidity	Ta=85°C,85%RH, I _F = 20 mA	1000 Hrs.	22 PCS.	0/1
5	Low Temperature Storage	Ta=-40°C	1000 Hrs.	22 PCS.	0/1
6	High Temperature Storage	Ta=100°C	1000 Hrs.	22 PCS.	0/1
7	DC Operation Life	Ta=25°C, I _F = 20 mA	1000 Hrs.	22 PCS.	0/1

EVERLIGHT

Precautions For Use

1. Over-current-proof

Customer must apply resistors for protection; otherwise slight voltage shift will cause big current change (Burn out will happen).

2. Storage

2.1 Do not open moisture proof bag before the products are ready to use.

2.2 Before opening the package: The LEDs should be kept at 30°C or less and 90%RH or less.

2.3 After opening the package: The LED's floor life is 168 Hrs under 30°C or less and 60% RH or less. If unused LEDs remain, it should be stored in moisture proof packages.

2.4 If the moisture absorbent material (silica gel) has faded away or the LEDs have exceeded the storage time, baking treatment should be performed using the following conditions.

Baking treatment: 60±5°C for 24 hours.

3. Soldering Condition

3.1 Pb-free solder temperature profile

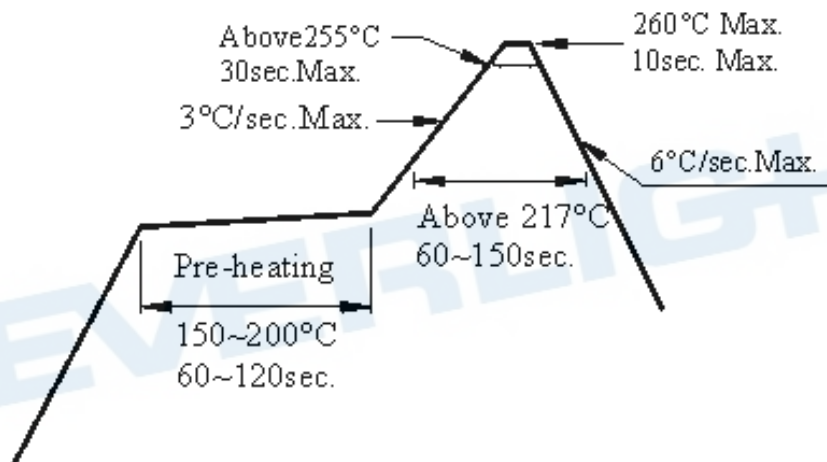

3.2 Reflow soldering should not be done more than two times.

3.3 When soldering, do not put stress on the LEDs during heating.

3.4 After soldering, do not warp the circuit board.

4. Soldering Iron

Each terminal is to go to the tip of soldering iron temperature less than 350°C for 3 seconds within once in less than the soldering iron capacity 25W. Leave two seconds and more intervals, and do soldering of each terminal. Be careful because the damage of the product is often started at the time of the hand solder.

5. Repairing

Repair should not be done after the LEDs have been soldered. When repairing is unavoidable, a double-head soldering iron should be used (as below figure). It should be confirmed beforehand whether the characteristics of the LEDs will or will not be damaged by repairing.

