

EAHP3535GA1

Introduction

The EAHP3535 series is a surface-mount high-power device featuring high brightness combined with a compact size that is suitable for all kinds of lighting applications such as general illumination, flash, spot, signal, industrial and commercial lighting. The thermal pad of this device is electrically isolated providing convenience in thermal and electrical design. The EAHP3535 series is one of the most promising devices in Everlight Americas high power product offering and is ready to face the challenges of today's Solid-State Lighting requirements.



Features

- ◆ LM-80 Certified
- ◆ Small package with high efficiency
- ◆ ESD protection up to 8KV
- ◆ Soldering method: SMT
- ◆ Binning Parameters: Brightness, Forward Voltage ,Wavelength and Chromaticity
- ◆ Moisture Sensitivity Level: 1
- ◆ RoHS compliant
- ◆ Matches ANSI binning

Applications

- ◆ General Lighting
- ◆ Decorative and Entertainment Lighting
- ◆ Signal and Symbol Luminaries for orientation marker lights (e.g. steps, exit ways, etc.)
- ◆ Exterior and Interior Automotive Illumination
- ◆ Agriculture Lighting

Absolute Maximum Ratings

Parameter	Symbol	Ratings	Unit
Max. DC Forward Current (mA)	I_F	600 _[1]	mA
Max. Peak Pulse Current (mA)	I_{Pulse}	1000 _[2]	mA
Max. ESD Resistance	V_B	8000	V
Reverse Voltage	V_R	Note 3	V
Thermal Resistance	R_{th}	10 ~ 12 _[4]	°C/W
Max. Junction Temperature	T_J	125 _[5]	°C
Operating Temperature	T_{Opr}	-40 ~ +100 _[6]	°C
Storage Temperature	T_{Stg}	-40 ~ +100	°C
Max. Soldering Temperature	T_{Sol}	260	°C
Max. Allowable Reflow Cycles	n/a	2	cycles

Notes:

- Maximum forward current for 1W is 600mA (Thermal Pad=25°C).
- Duty cycle = 1/10@1KHZ
- The EAHP3535 series LEDs are not designed for reverse bias use.
- Thermal Resistance is 10°C/W for Blue, Green, Cool-White, Neutral-White, and Warm-White LEDs and 12°C/W for Red, Amber, and Orange LEDs.
- Maximum junction temperature of Cool-White, Neutral-White, Warm-White, Blue, Green, Red, Amber, and Orange LEDs is 125°C.
- Maximum Operating Temperature (Thermal Pad) of Cool-White, Neutral-White, Warm-White, Blue, Green, Red, Amber, and Orange LEDs is 100°C.

JEDEC Moisture Sensitivity

Level	Floor Life		Soak Requirements Standard	
	Time (hours)	Conditions	Time (hours)	Conditions
1	Unlimited	≤30°C / 85% RH	168 (+5/-0)	85°C / 85% RH

PN of the EAHP3535 series: Color LEDs

Color	Order Code	Minimum Luminous Flux (lm)	Wavelength (nm)	Forward Voltage(V)
Green	EAHP3535GA1	70	525~535	2.65~3.85

*Product lead time of at least 8 weeks.

Note:

Each 1W direct color PN is based on the min. bin and includes four adjacent bins.

EVERLIGHT

Product Binning

Luminous Flux Bins

Group	Bin	Minimum Photometric Flux (lm)	Maximum Photometric Flux (lm)
E	1	4	5
	2	5	6
	3	6	8
	4	8	10
	5	10	13
	6	13	17
	7	17	20
	8	20	23
	9	23	27
F	1	27	33
	2	33	39
	3	39	45
	4	45	52
	5	52	60
	6	60	70
	7	70	80
	8	80	90
	9	90	100

Group	Bin	Minimum Photometric Flux (lm)	Maximum Photometric Flux (lm)
J	1	100	110
	2	110	120
	3	120	130
	4	130	140
	5	140	150
	6	150	160
	7	160	180
	8	180	200
	9	200	225
K	1	225	250
	2	250	275
	3	275	300
	4	300	325
	5	325	350
	6	350	375
	7	375	400
	8	400	425
	9	425	450
N	1	450	475
	2	475	500
	3	500	525
	4	525	550

Radiometric Power Bins

Group	Bin	Minimum Radiometric Power(mW)	Maximum Radiometric Power(mW)
Q	1	0	25
	2	25	50
	3	50	75
	4	75	100
	5	100	125
	6	125	175
	7	175	225
	8	225	275
	9	275	350

Group	Bin	Minimum Radiometric Power(mW)	Maximum Radiometric Power(mW)
R	1	350	425
	2	425	500
	3	500	600
	4	600	700
	5	700	800
	6	800	900
	7	900	1000
	8	1000	1300
	9	1300	1600

Forward Voltage Bins

Bin	Minimum Forward Voltage (V)	Maximum Forward Voltage (V)
U1	1.75	2.05
U2	2.05	2.35
U3	2.35	2.65
U4	2.65	2.95
V1	2.95	3.25
V2	3.25	3.55
V3	3.55	3.85
V4	3.85	4.15

Notes:

1. Forward voltage measurement tolerance: $\pm 0.1V$.
2. Forward voltage bins are defined at $I_f=350mA$ operation.
3. Other Forward Voltage bins for White LEDs available upon request. Please contact your local Everlight Americas sales office.

EVERLIGHT

Color Bins

Group	Bin	Minimum Dominant Wavelength (nm)	Maximum Dominant Wavelength (nm)
B (Blue)	1	430	435
	2	435	440
	3	440	445
	4	445	450
	5	450	455
	6	455	460
	7	460	465
	8	465	470
G (Green)	1	520	525
	2	525	530
	3	530	535
	4	535	540
	5	540	545
	6	545	550
A (Amber)	1	580	582.5
	2	582.5	585
	3	585	587.5
	4	587.5	590
	5	590	592.5
R (Red)	6	592.5	595
	3	610	615
	4	615	620
	5	620	625
	6	625	630
D (Deep-Red)	1	635	640
	2	640	645
	3	645	650
	4	650	655
	5	655	660
	6	660	665
	7	665	670
	8	670	675
F (Far-Red)	1	700	710
	2	710	715
	3	715	720
	4	720	725
	5	725	730
	6	730	735
	7	735	740
	8	740	745

Notes:

1. Dominant / Peak wavelength measurement tolerance: $\pm 1\text{nm}$.
2. Dominant / Peak wavelength bins are defined at $I_F=350\text{ mA}$ operation.
3. The range of wavelength in Royal-Blue, Deep-Red and Far-Red is described as peak-wavelength.

Optical Characteristics

Color	Dominant Wavelength λ_D Peak Wavelength λ_P Color Temperature CCT			Typical Temperature Coefficient of Dominant Wavelength (nm/°C)-($\Delta\lambda_D/\Delta T_J$)	Typical Viewing Angle (degrees) $2\theta_{1/2}$
	Min.	Typ.	Max.		
Cool-White	4745K	5700K	7050K	---	Note 5
Neutral-White	3710K	4260K	4745K	---	Note 5
Warm-White	2580K	3000K	3710K	---	Note 5
Red	620nm	---	630nm	0.05	120
Orange	610nm	---	620nm	0.08	120
Amber	585nm	---	595nm	0.1	120
Green	520nm	---	535nm	0.05	120
Blue	460nm	---	470nm	0.05	120
Deep-Red	645nm	---	675nm	0.08	120
Far-Red	715nm	---	745nm	0.04	120

Notes:

1. The test tolerance of Everlight Americas is $\pm 0.5\text{nm}$ for dominant wavelength, $\pm 5\%$ for CCT.
2. Viewing angle is the width of half the light output intensity in all directions of 180° .
3. All Cool-White, Neutral-White, Warm-White, and dominant wavelength below 550nm LEDs are made with Indium Gallium Nitride (InGaN).
4. All LEDs with dominant wavelength exceeding 550nm are made with Aluminum Indium Gallium Phosphide (AlInGaP).

Mechanical Dimension

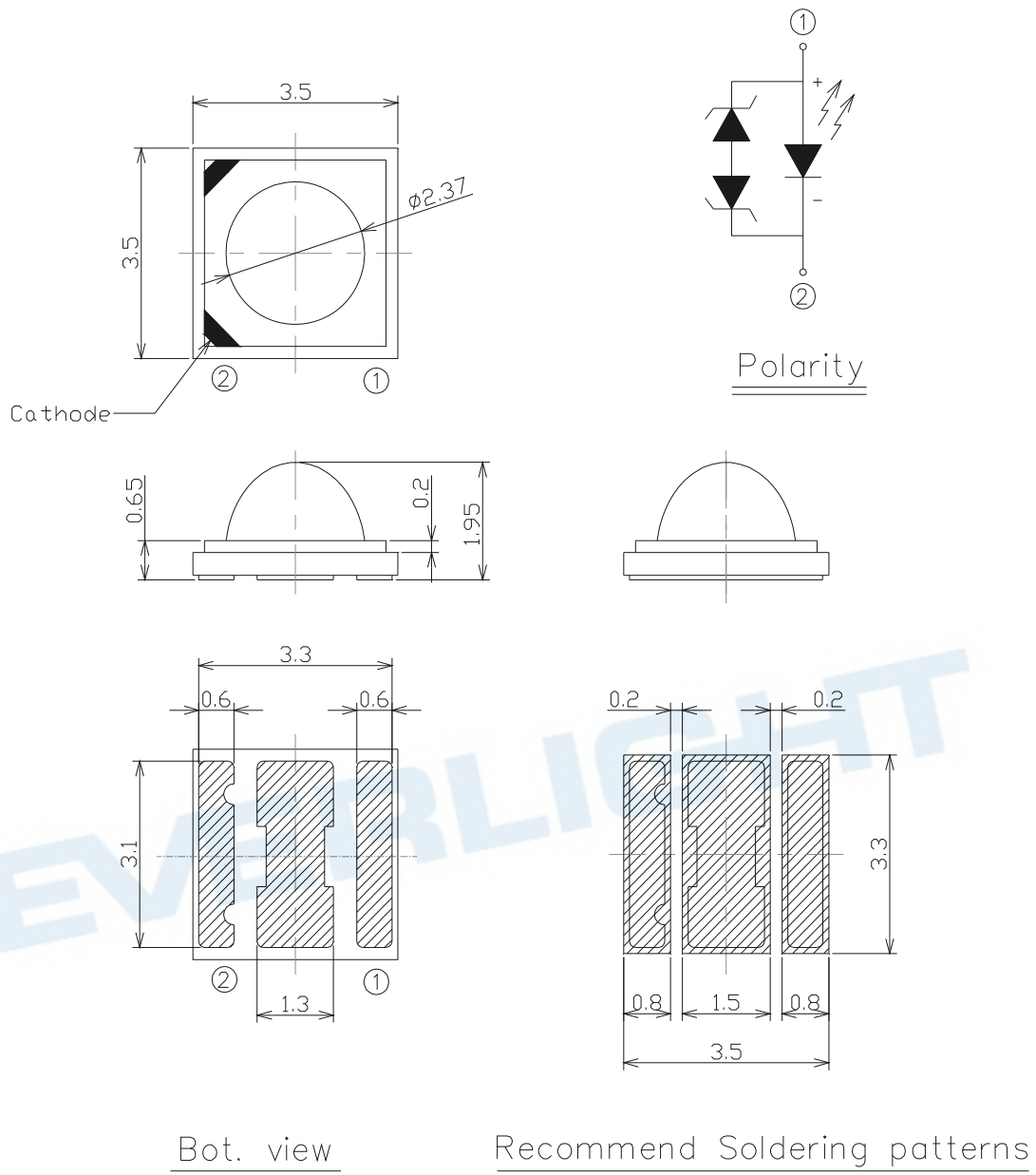

Notes:

1. Dimensions are in millimeters.
2. Tolerances unless mentioned are $\pm 0.15\text{mm}$.
3. The thermal pad is electrically isolated from the Anode and Cathode contact pads.
4. Do not handle the device by the lens. Incorrect force applied to the lens may lead to the failure of devices.

Pad Configuration

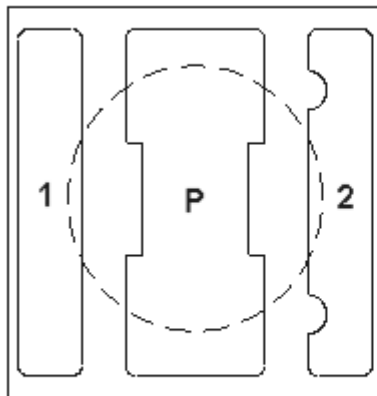

BOTTOM VIEW

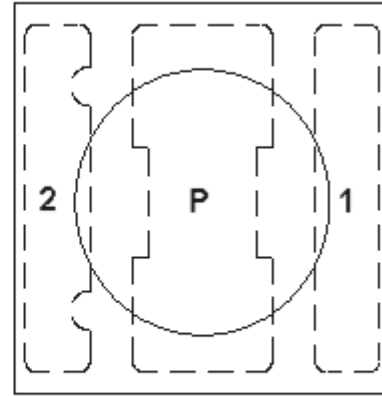

TOP VIEW

PAD	FUNCTION
1	ANODE
2	CATHODE
P	THERMAL PAD

Reflow Soldering Characteristics

For Reflow Process

- a. EAHP3535 series are suitable for SMT processes.
- b. Curing of glue in oven must be according to standard operation flow processes.

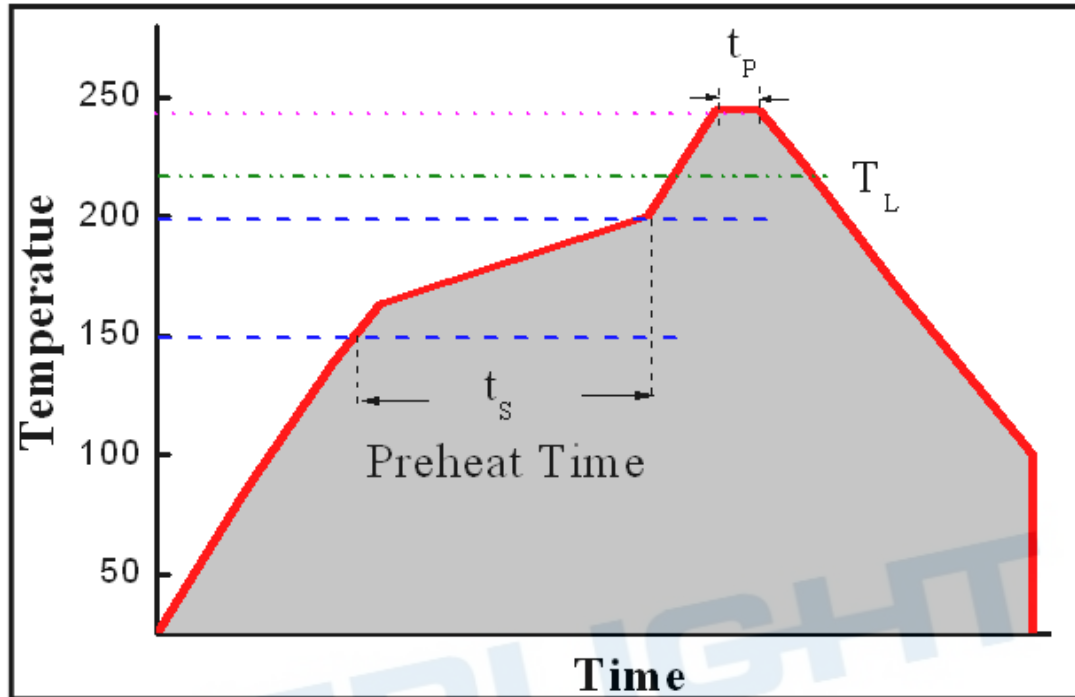

Profile Feature	Lead Free Assembly
Ramp-Up Rate	2-3 °C/S
Preheat Temperature	150-200 °C
Preheat Time (t_s)	60-120 S
Liquid Temperature (T_L)	217 °C
Time maintained above T_L	60-90 S
Peak Temperature (T_P)	240±5 °C
Peak Time (t_p)	Max 20 S
Ramp-Down Rate	3-5 °C/S

- c. Reflow soldering should not be done more than twice.
- d. In soldering process, stress on the LEDs during heating should be avoided.
- e. After soldering, do not bend the circuit board.

Wavelength Characteristics

For Deep-Red, Red, Amber, Yellow, Green, Cyan, Blue, Royal-Blue
@ Thermal Pad Temperature = 25°C

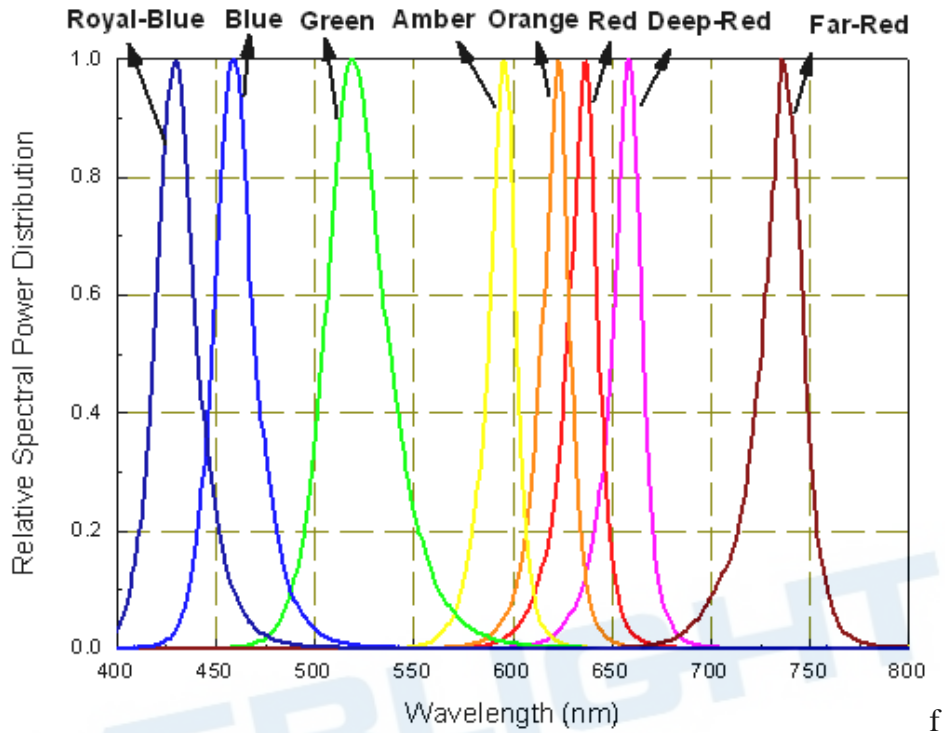

Typical Light Output Characteristic V.S. Thermal Pad Temperature

Cool-White, Neutral-White, Warm-White, Green, Cyan, Blue, Royal-Blue
for 350mA Drive Current

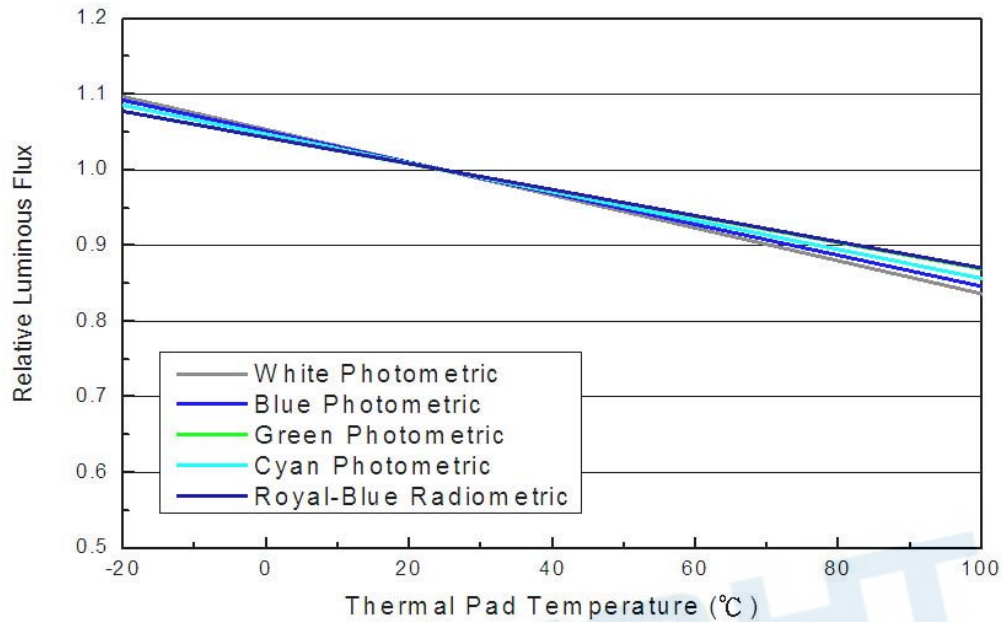

Deep-Red, Red, Orange, Amber for 350mA Drive Current

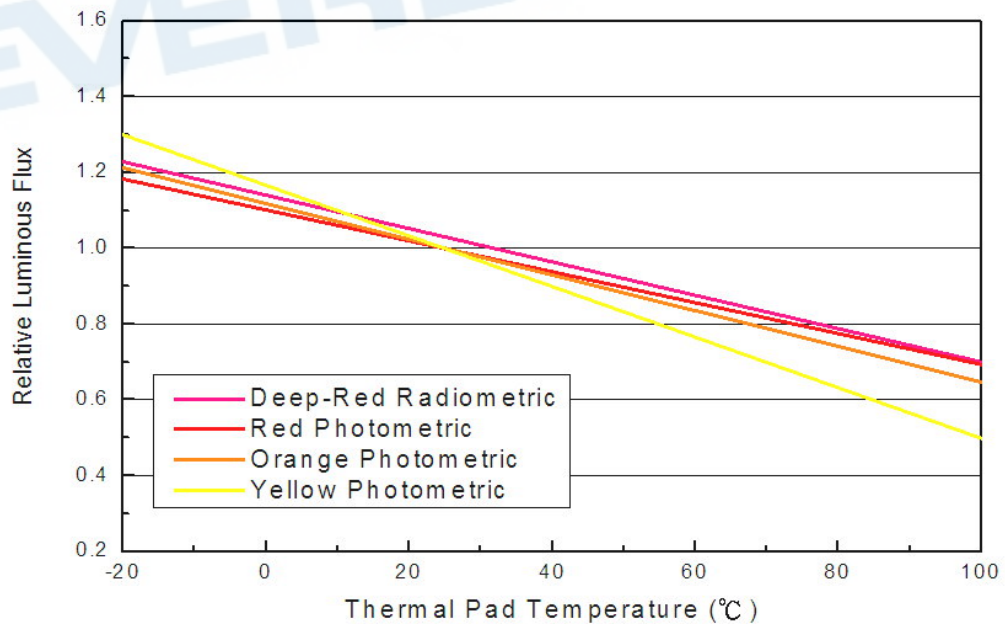

Typical Electrical Characteristics

For Cool-White, Neutral-White, Warm-White, Green, Blue
@ Thermal Pad Temperature = 25°C

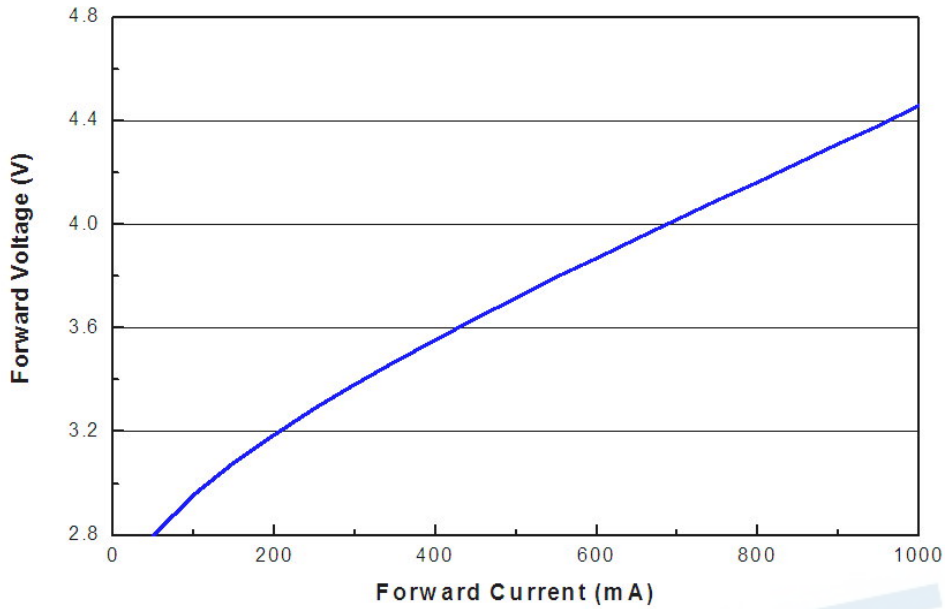

For Red, Orange, Amber,
@ Thermal Pad Temperature = 25°C

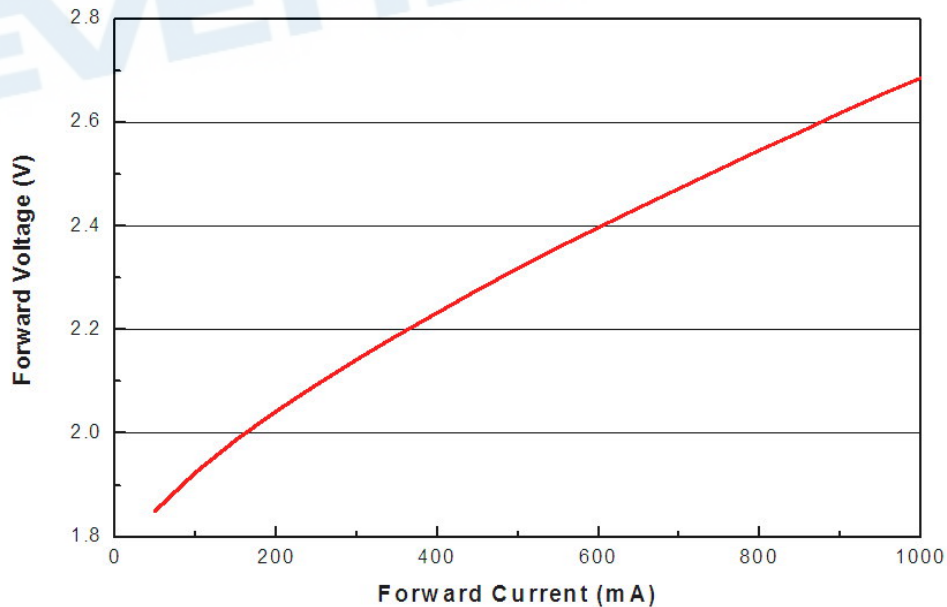

Typical Relative Luminous Flux V.S. Forward Current

For Green, Blue, @ Thermal Pad Temperature = 25°C

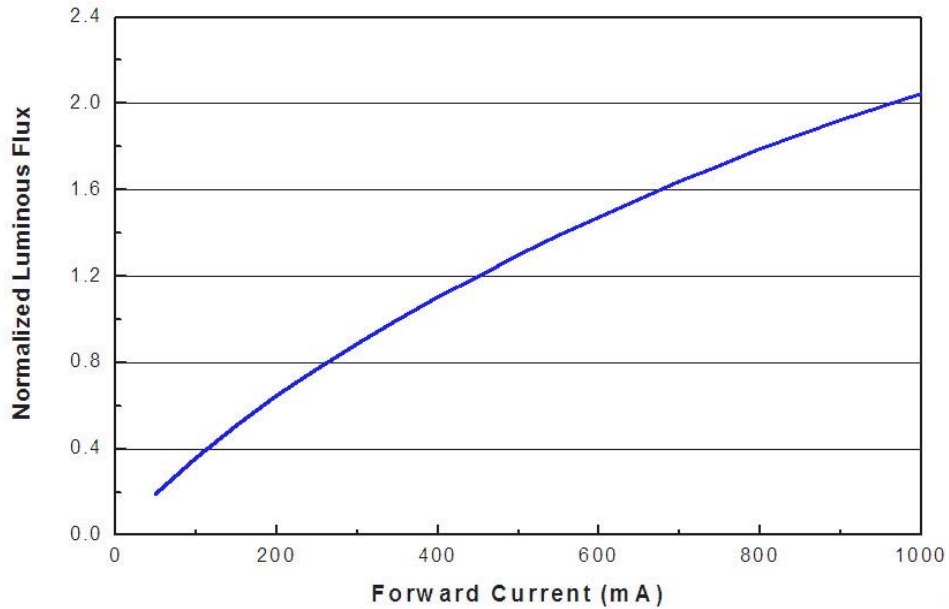

For Red, Orange, Amber,
@ Thermal Pad Temperature = 25°C

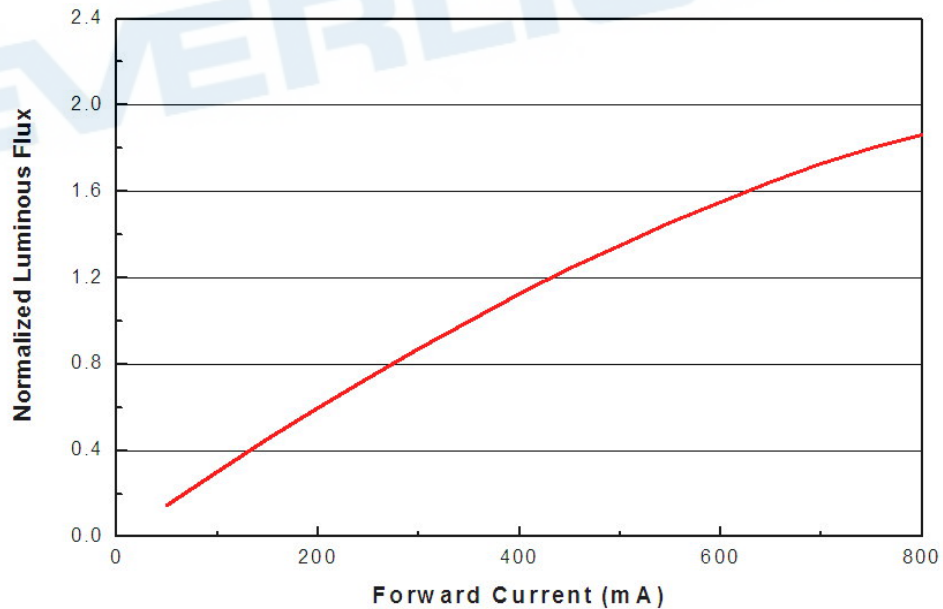

Typical Wavelength Shift Characteristics V.S. Forward Current

For Blue @ Thermal Pad Temperature = 25°C

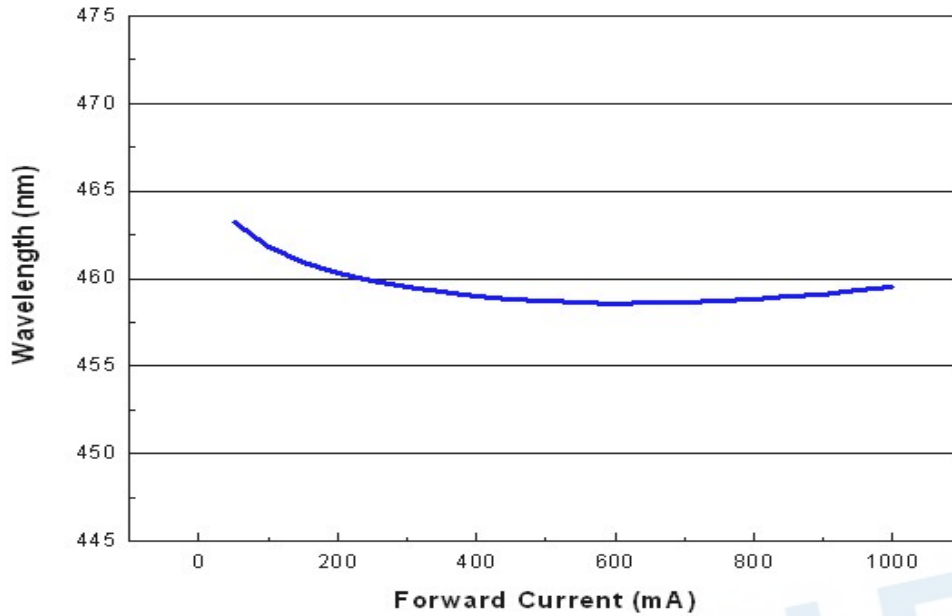

For Green @ Thermal Pad Temperature = 25°C

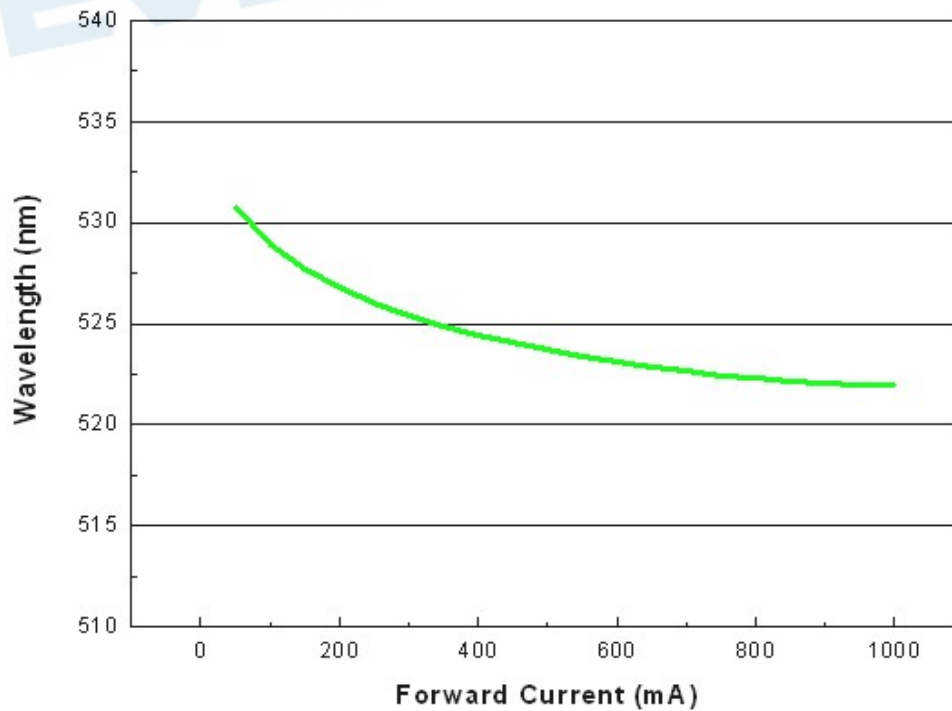

For Red @ Thermal Pad Temperature = 25°C

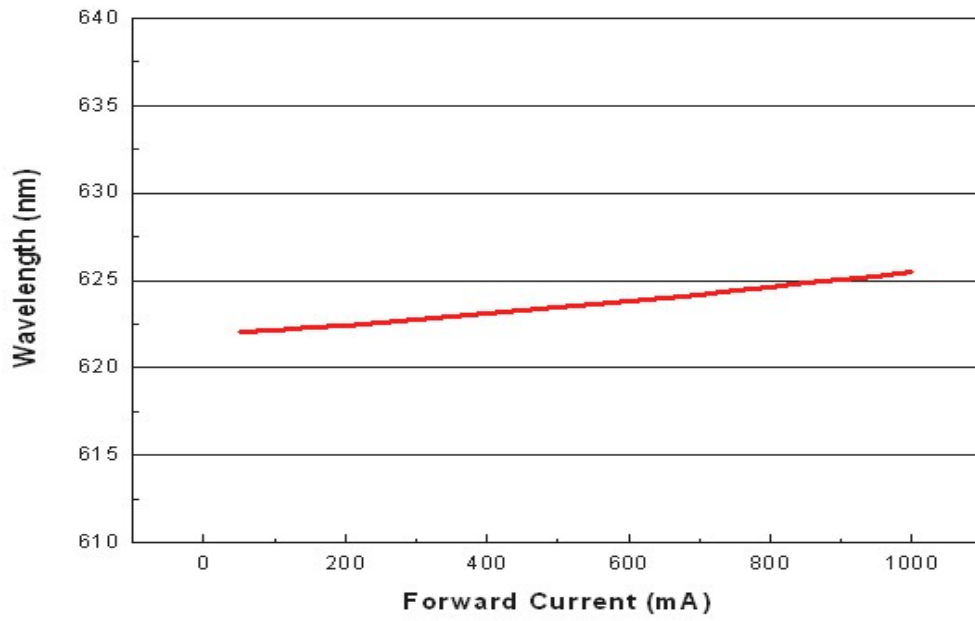

EVERLIGHT

Relative Flux and Forward Voltage V.S. Junction Temperature (IF = 350 mA)

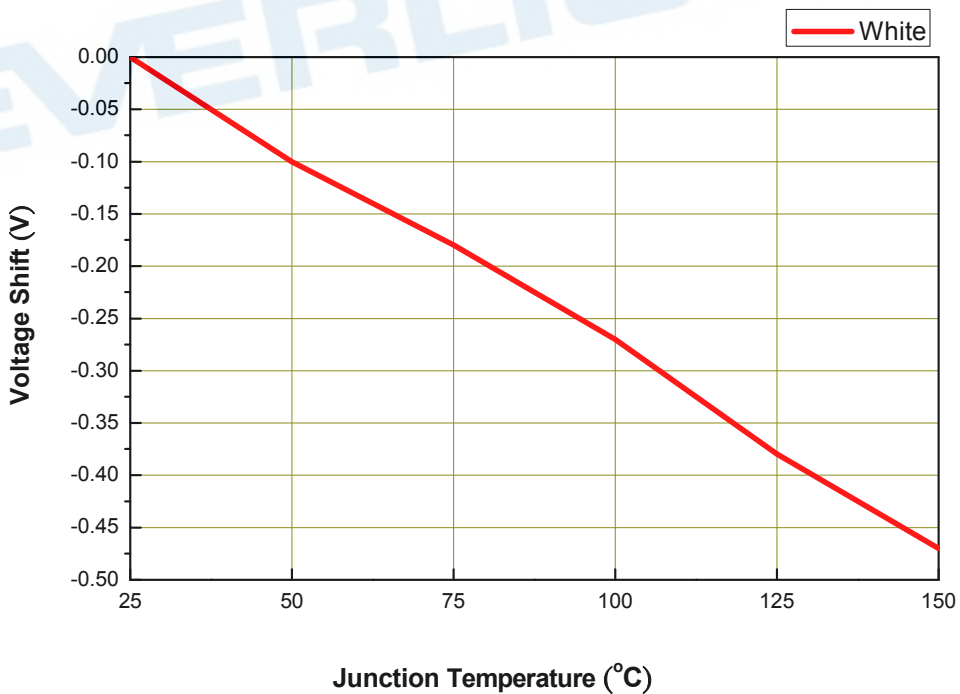
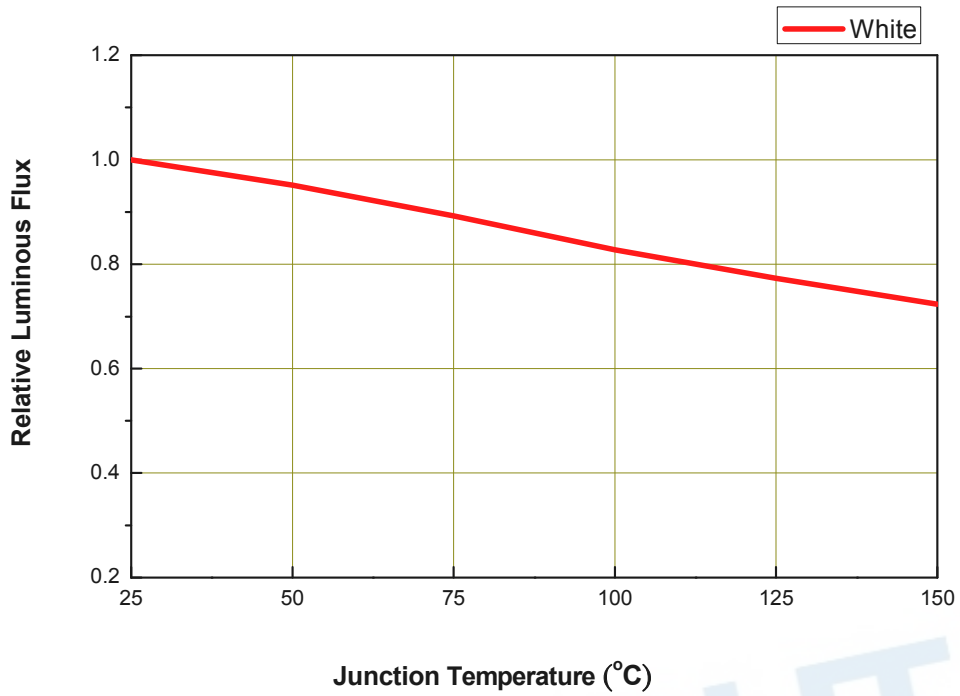

Current Derating Curves

Current Derating Curve for 350mA Drive Current
Cool-White, Neutral-White, Warm-White, Green, Cyan, Blue, Royal-Blue, Far-Red,
Deep-Red, Red, Amber, Yellow

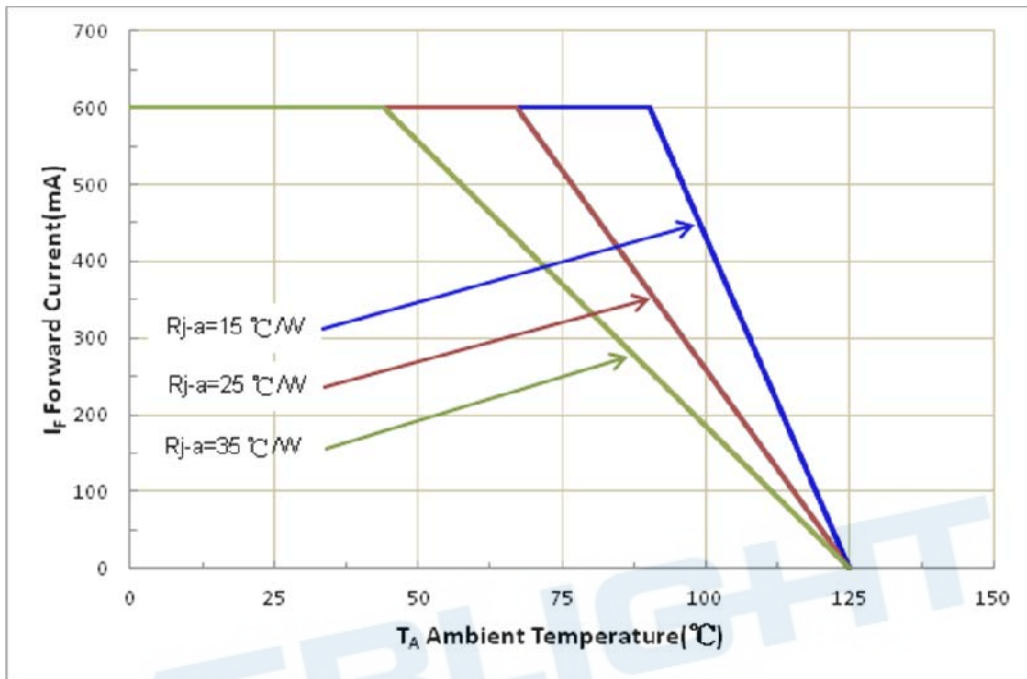

Typical Radiation Patterns

Typical Diagram Characteristics of Radiation for Cool-White, Neutral-White, Warm-White

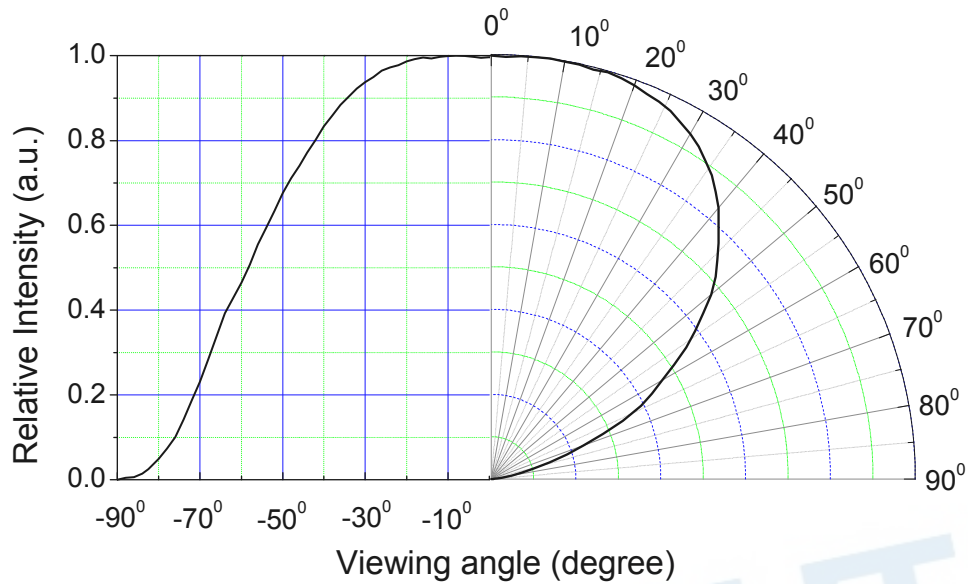

Notes:

1. $2\theta_{1/2}$ is the off axis angle from lamp centerline where the luminous intensity is 1/2 of the peak value.
2. View angle tolerance is $\pm 5^\circ$.

Emitter Tape Packaging

Carrier Tape Dimensions as the following:

Reel: 400pcs, MOQ \geq 2Kpcs(has to be a multiple of 400pcs)

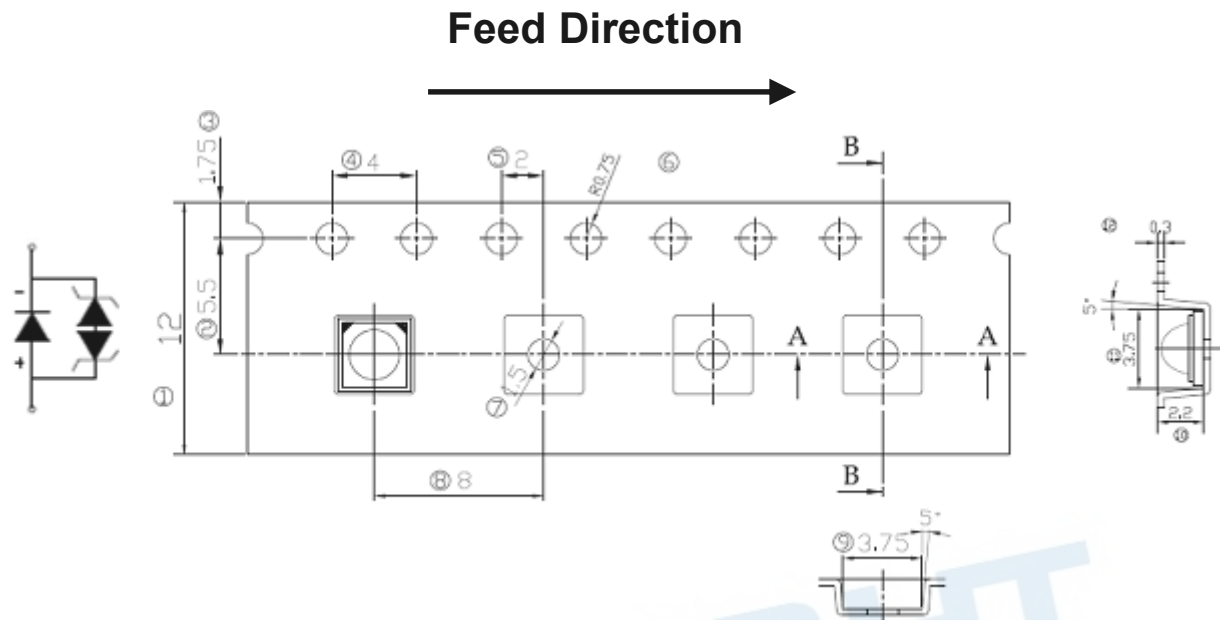

Notes:

1. Dimensions are in millimeters.
2. Tolerances for fixed dimensions are $\pm 0.1\text{mm}$.

Moisture Resistant Packaging

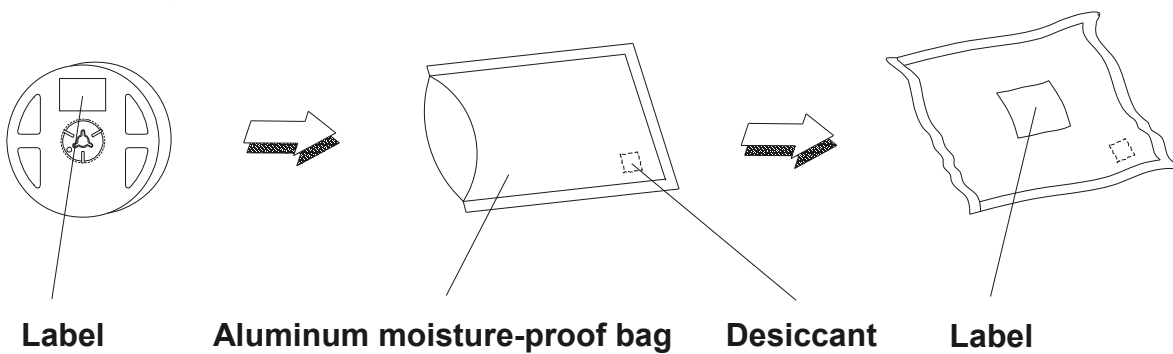

Emitter Reel Packaging

Reel Dimensions

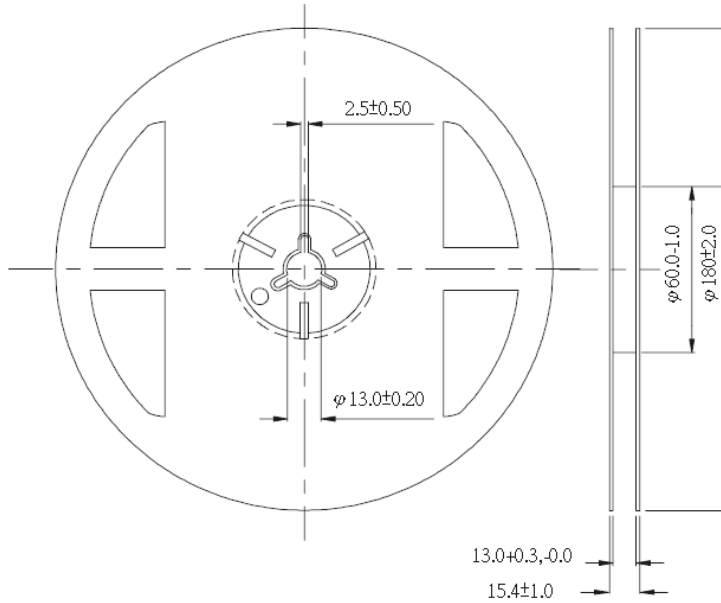

Notes:

1. Dimensions are in millimeters.
2. Tolerances unless mentioned are ± 0.1 mm.

Product Labeling

Label Explanation

CPN: Customer Specification (when required)

P/N : Everlight Americas Production Number

QTY: Packing Quantity

CAT: Luminous Flux (Brightness) Bin

HUE: Color Bin

REF: Forward Voltage Bin

LOT No: Lot Number

MADE IN TAIWAN: Production Place



Storage Conditions

- Before the package is opened. The LEDs should be stored at 30°C or less and 85%RH or less after being shipped from Everlight Americas and the storage life limits are 1 year. The LEDs can be stored up to 3 years If in a sealed container with a nitrogen atmosphere and moisture absorbent material.
- After opening the package: The LED's floor life is 1 year under 30°C or less and 60%RH or less. The LED should be soldered with 168hrs (7days) after opening the package. If unused LEDs remain, it should be stored in moisture proof packages.
- If the moisture absorbent material (silica gel) has faded away or the LEDs have exceeded the storage time, baking treatment should be performed using the following conditions. Baking treatment: 60±5°C for 24 hours.

EVERLIGHT

Revision History

Current version: 2014/07/03

Device No: DHE-0002574

Version. 1

Page	Subjects (major change in previous version)	Date of change

EVERLIGHT