

EAHP3535BA1

Introduction

The EAHP3535 series is a surface-mount high-power device featuring high brightness combined with a compact size that is suitable for all kinds of lighting applications such as general illumination, flash, spot, signal, industrial and commercial lighting. The thermal pad of this device is electrically isolated providing convenience in thermal and electrical design. The EAHP3535 series is one of the most promising devices in Everlight Americas high power product offering and is ready to face the challenges of today's Solid-State Lighting requirements.



Features

- ◆ LM-80 Certified
- ◆ Small package with high efficiency
- ◆ ESD protection up to 8KV
- ◆ Soldering method: SMT
- ◆ Binning Parameters: Brightness, Forward Voltage, Wavelength and Chromaticity
- ◆ Moisture Sensitivity Level: 1
- ◆ RoHS compliant
- ◆ Matches ANSI binning

Applications

- ◆ General Lighting
- ◆ Decorative and Entertainment Lighting
- ◆ Signal and Symbol Luminaries for orientation marker lights (e.g. steps, exit ways, etc.)
- ◆ Exterior and Interior Automotive Illumination
- ◆ Agriculture Lighting

Absolute Maximum Ratings

| Parameter | Symbol | Ratings | Unit |
|------------------------------|-------------|---------------------------|--------|
| Max. DC Forward Current (mA) | I_F | 750 ^[1] | mA |
| Max. Peak Pulse Current (mA) | I_{Pulse} | 1000 ^[2] | mA |
| Max. ESD Resistance | V_B | 8000 | V |
| Reverse Voltage | V_R | Note 3 | V |
| Thermal Resistance | R_{th} | 10 ~ 12 ^[4] | °C/W |
| Max. Junction Temperature | T_J | 125 ^[5] | °C |
| Operating Temperature | T_{Opr} | -40 ~ +100 ^[6] | °C |
| Storage Temperature | T_{Stg} | -40 ~ +100 | °C |
| Max. Soldering Temperature | T_{Sol} | 260 | °C |
| Max. Allowable Reflow Cycles | n/a | 2 | cycles |

Notes:

1. Maximum forward current for 3W is 750mA (Thermal Pad=25°C).
2. Duty cycle = 1/10@1KHZ
3. The EAHP3535 series LEDs are not designed for reverse bias use.
4. Thermal Resistance is 10°C/W for Blue, Green, Cool-White, Neutral-White, and Warm-White LEDs and 12°C/W for Red, Amber, and Orange LEDs.
5. Maximum junction temperature of Cool-White, Neutral-White, Warm-White, Blue, Green, Red, Amber, and Orange LEDs is 125°C.
6. Maximum Operating Temperature (Thermal Pad) of Cool-White, Neutral-White, Warm-White, Blue, Green, Red, Amber, and Orange LEDs is 100°C.

JEDEC Moisture Sensitivity

| Level | Floor Life | | Soak Requirements Standard | |
|-------|--------------|----------------|----------------------------|---------------|
| | Time (hours) | Conditions | Time (hours) | Conditions |
| 1 | Unlimited | ≤30°C / 85% RH | 168 (+5/-0) | 85°C / 85% RH |

PN of the EAHP3535 series: Color LEDs

| Color | Order Code | Minimum Luminous Flux (lm) | Wavelength (nm) | Forward Voltage(V) | Drive Current(mA) |
|-------|-------------|----------------------------|-----------------|--------------------|-------------------|
| Blue | EAHP3535BA1 | 23 | 455~470 | 2.95~4.15 | 350 |

***Product lead time of at least 8 weeks.**

Note:

Each 1W direct color PN is based on the min. bin and includes four adjacent bins.

EVERLIGHT

Product Binning

Luminous Flux Bins

| Group | Bin | Minimum Photometric Flux (lm) | Maximum Photometric Flux (lm) |
|-------|-----|-------------------------------|-------------------------------|
| E | 1 | 4 | 5 |
| | 2 | 5 | 6 |
| | 3 | 6 | 8 |
| | 4 | 8 | 10 |
| | 5 | 10 | 13 |
| | 6 | 13 | 17 |
| | 7 | 17 | 20 |
| | 8 | 20 | 23 |
| | 9 | 23 | 27 |
| F | 1 | 27 | 33 |
| | 2 | 33 | 39 |
| | 3 | 39 | 45 |
| | 4 | 45 | 52 |
| | 5 | 52 | 60 |
| | 6 | 60 | 70 |
| | 7 | 70 | 80 |
| | 8 | 80 | 90 |
| | 9 | 90 | 100 |

| Group | Bin | Minimum Photometric Flux (lm) | Maximum Photometric Flux (lm) |
|-------|-----|-------------------------------|-------------------------------|
| J | 1 | 100 | 110 |
| | 2 | 110 | 120 |
| | 3 | 120 | 130 |
| | 4 | 130 | 140 |
| | 5 | 140 | 150 |
| | 6 | 150 | 160 |
| | 7 | 160 | 180 |
| | 8 | 180 | 200 |
| | 9 | 200 | 225 |
| K | 1 | 225 | 250 |
| | 2 | 250 | 275 |
| | 3 | 275 | 300 |
| | 4 | 300 | 325 |
| | 5 | 325 | 350 |
| | 6 | 350 | 375 |
| | 7 | 375 | 400 |
| | 8 | 400 | 425 |
| | 9 | 425 | 450 |
| N | 1 | 450 | 475 |
| | 2 | 475 | 500 |
| | 3 | 500 | 525 |
| | 4 | 525 | 550 |

Radiometric Power Bins

| Group | Bin | Minimum Radiometric Power(mW) | Maximum Radiometric Power(mW) |
|-------|-----|-------------------------------|-------------------------------|
| Q | 1 | 0 | 25 |
| | 2 | 25 | 50 |
| | 3 | 50 | 75 |
| | 4 | 75 | 100 |
| | 5 | 100 | 125 |
| | 6 | 125 | 175 |
| | 7 | 175 | 225 |
| | 8 | 225 | 275 |
| | 9 | 275 | 350 |

| Group | Bin | Minimum Radiometric Power(mW) | Maximum Radiometric Power(mW) |
|-------|-----|-------------------------------|-------------------------------|
| R | 1 | 350 | 425 |
| | 2 | 425 | 500 |
| | 3 | 500 | 600 |
| | 4 | 600 | 700 |
| | 5 | 700 | 800 |
| | 6 | 800 | 900 |
| | 7 | 900 | 1000 |
| | 8 | 1000 | 1300 |
| | 9 | 1300 | 1600 |

Forward Voltage Bins

| Bin | Minimum Forward Voltage (V) | Maximum Forward Voltage (V) |
|-----|-----------------------------|-----------------------------|
| U1 | 1.75 | 2.05 |
| U2 | 2.05 | 2.35 |
| U3 | 2.35 | 2.65 |
| U4 | 2.65 | 2.95 |
| V1 | 2.95 | 3.25 |
| V2 | 3.25 | 3.55 |
| V3 | 3.55 | 3.85 |
| V4 | 3.85 | 4.15 |

Notes:

1. Forward voltage measurement tolerance: $\pm 0.1V$.
2. Forward voltage bins are defined at $I_f=350mA$ operation.
3. Other Forward Voltage bins for White LEDs available upon request. Please contact your local Everlight Americas sales office.

EVERLIGHT

Color Bins

| Group | Bin | Minimum Dominant Wavelength (nm) | Maximum Dominant Wavelength (nm) |
|------------------------|-----|----------------------------------|----------------------------------|
| B (Blue) | 1 | 430 | 435 |
| | 2 | 435 | 440 |
| | 3 | 440 | 445 |
| | 4 | 445 | 450 |
| | 5 | 450 | 455 |
| | 6 | 455 | 460 |
| | 7 | 460 | 465 |
| | 8 | 465 | 470 |
| G (Green) | 1 | 520 | 525 |
| | 2 | 525 | 530 |
| | 3 | 530 | 535 |
| | 4 | 535 | 540 |
| | 5 | 540 | 545 |
| | 6 | 545 | 550 |
| A (Amber) | 1 | 580 | 582.5 |
| | 2 | 582.5 | 585 |
| | 3 | 585 | 587.5 |
| | 4 | 587.5 | 590 |
| | 5 | 590 | 592.5 |
| R (Red) | 6 | 592.5 | 595 |
| | 3 | 610 | 615 |
| | 4 | 615 | 620 |
| | 5 | 620 | 625 |
| | 6 | 625 | 630 |
| D (Deep-Red) | 1 | 635 | 640 |
| | 2 | 640 | 645 |
| | 3 | 645 | 650 |
| | 4 | 650 | 655 |
| | 5 | 655 | 660 |
| | 6 | 660 | 665 |
| | 7 | 665 | 670 |
| | 8 | 670 | 675 |
| F (Far-Red) | 1 | 700 | 710 |
| | 2 | 710 | 715 |
| | 3 | 715 | 720 |
| | 4 | 720 | 725 |
| | 5 | 725 | 730 |
| | 6 | 730 | 735 |
| | 7 | 735 | 740 |
| | 8 | 740 | 745 |

Notes:

1. Dominant / Peak wavelength measurement tolerance: $\pm 1\text{nm}$.
2. Dominant / Peak wavelength bins are defined at $I_f=350\text{ mA}$ operation.
3. The range of wavelength in Royal-Blue, Deep-Red and Far-Red is described as peak-wavelength.

Optical Characteristics

| Color | Dominant Wavelength λ_D Peak Wavelength λ_P Color Temperature CCT | | | Typical Temperature Coefficient of Dominant Wavelength (nm/°C)-($\Delta\lambda_D/\Delta T_J$) | Typical Viewing Angle (degrees) $2\theta_{1/2}$ |
|---------------|---|-------|-------|--|--|
| | Min. | Typ. | Max. | | |
| Cool-White | 4745K | 5700K | 7050K | --- | Note 5 |
| Neutral-White | 3710K | 4260K | 4745K | --- | Note 5 |
| Warm-White | 2580K | 3000K | 3710K | --- | Note 5 |
| Red | 620nm | --- | 630nm | 0.05 | 120 |
| Orange | 610nm | --- | 620nm | 0.08 | 120 |
| Amber | 585nm | --- | 595nm | 0.1 | 120 |
| Green | 520nm | --- | 535nm | 0.05 | 120 |
| Blue | 460nm | --- | 470nm | 0.05 | 120 |
| Deep-Red | 645nm | --- | 675nm | 0.08 | 120 |
| Far-Red | 715nm | --- | 745nm | 0.04 | 120 |

Notes:

1. The test tolerance of Everlight Americas is $\pm 0.5\text{nm}$ for dominant wavelength, $\pm 5\%$ for CCT.
2. Viewing angle is the width of half the light output intensity in all directions of 180° .
3. All Cool-White, Neutral-White, Warm-White, and dominant wavelength below 550nm LEDs are made with Indium Gallium Nitride (InGaN).
4. All LEDs with dominant wavelength exceeding 550nm are made with Aluminum Indium Gallium Phosphide (AlInGaP).

Mechanical Dimension

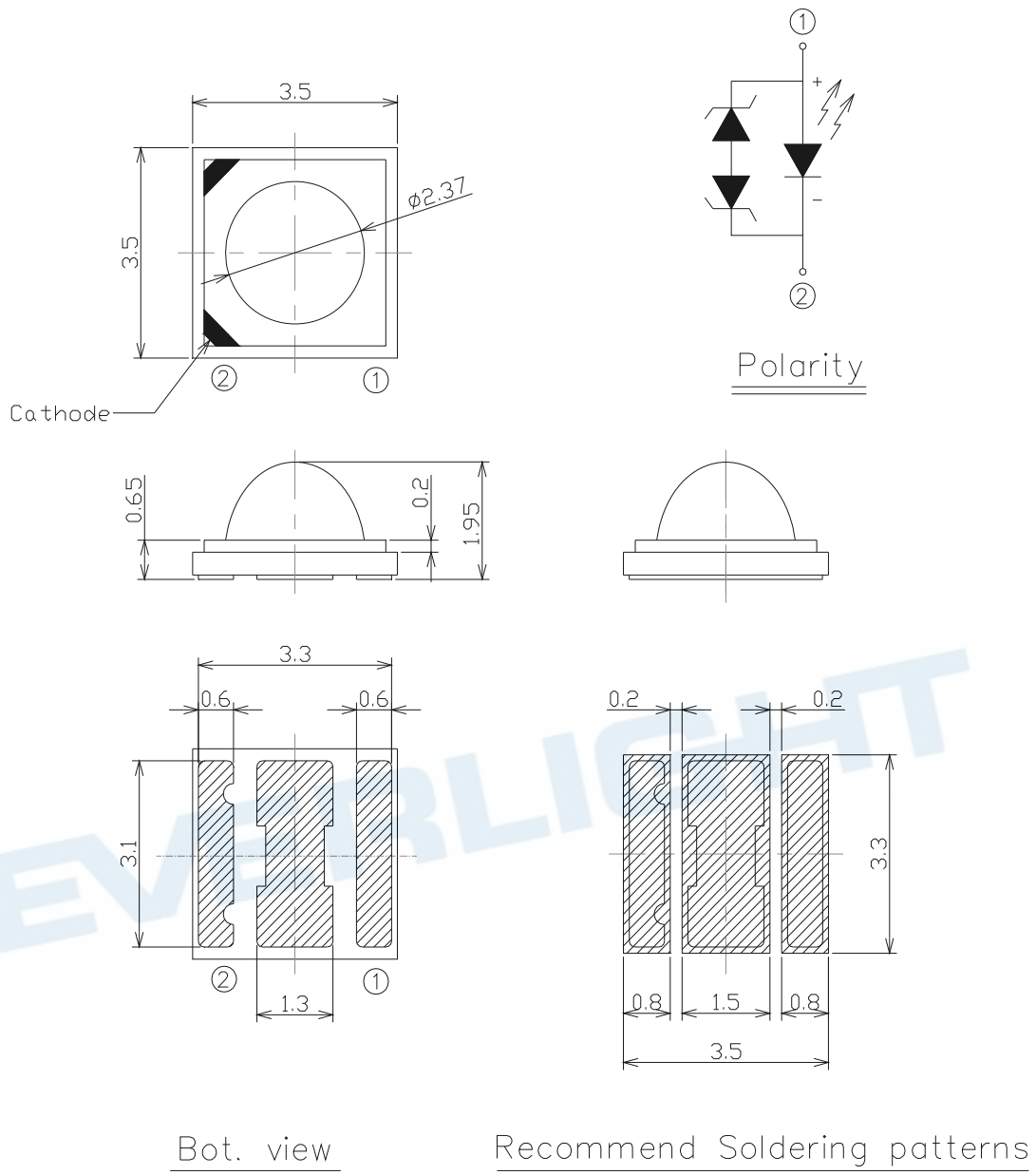

Notes:

1. Dimensions are in millimeters.
2. Tolerances unless mentioned are $\pm 0.15\text{mm}$.
3. The thermal pad is electrically isolated from the Anode and Cathode contact pads.
4. Do not handle the device by the lens. Incorrect force applied to the lens may lead to the failure of devices.

Pad Configuration

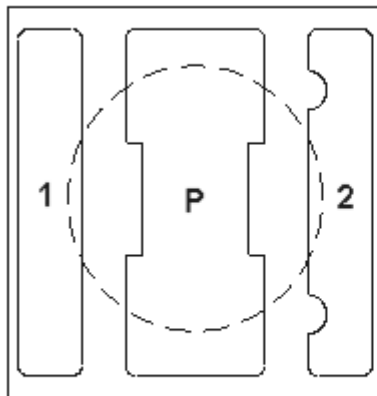

BOTTOM VIEW

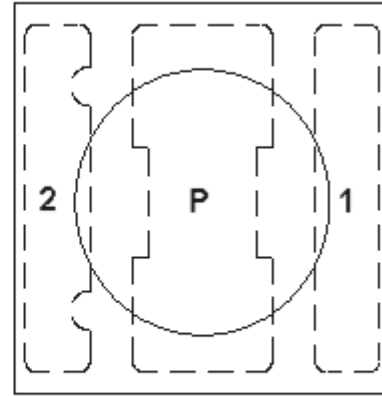

TOP VIEW

| PAD | FUNCTION |
|-----|-------------|
| 1 | ANODE |
| 2 | CATHODE |
| P | THERMAL PAD |

Reflow Soldering Characteristics

For Reflow Process

- a. EAHP3535 series are suitable for SMT processes.
- b. Curing of glue in oven must be according to standard operation flow processes.

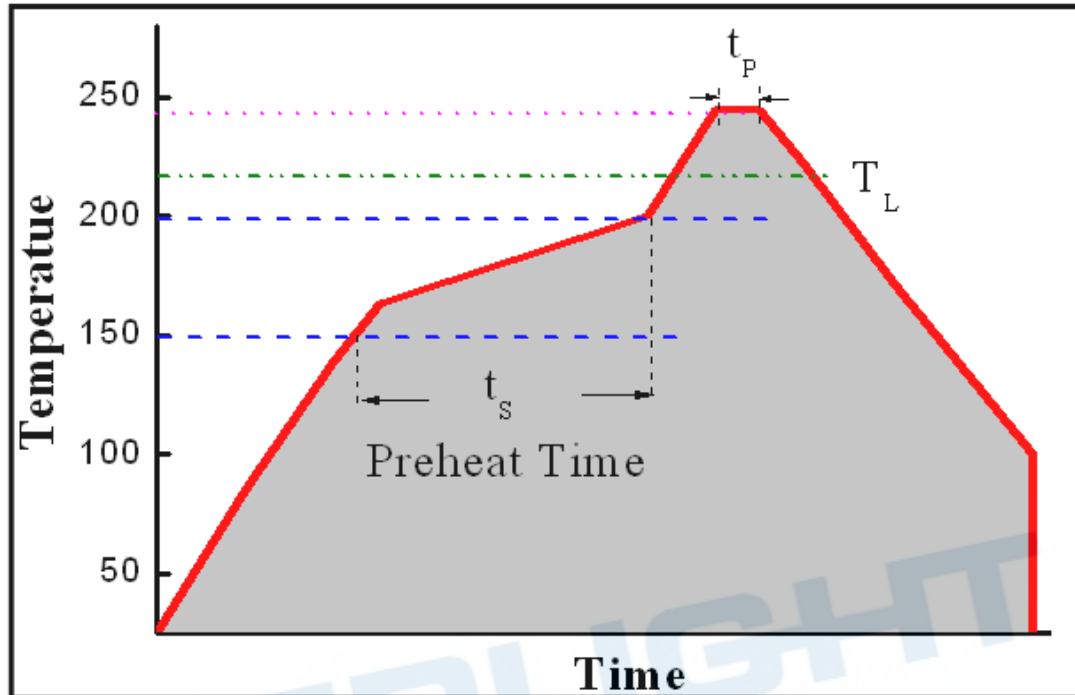

| Profile Feature | Lead Free Assembly |
|------------------------------|--------------------|
| Ramp-Up Rate | 2-3 °C/S |
| Preheat Temperature | 150-200 °C |
| Preheat Time (t_s) | 60-120 S |
| Liquid Temperature (T_L) | 217 °C |
| Time maintained above T_L | 60-90 S |
| Peak Temperature (T_P) | 240±5 °C |
| Peak Time (t_p) | Max 20 S |
| Ramp-Down Rate | 3-5 °C/S |

- c. Reflow soldering should not be done more than twice.
- d. In soldering process, stress on the LEDs during heating should be avoided.
- e. After soldering, do not bend the circuit board.

Wavelength Characteristics

For Deep-Red, Red, Amber, Yellow, Green, Cyan, Blue, Royal-Blue
@ Thermal Pad Temperature = 25°C

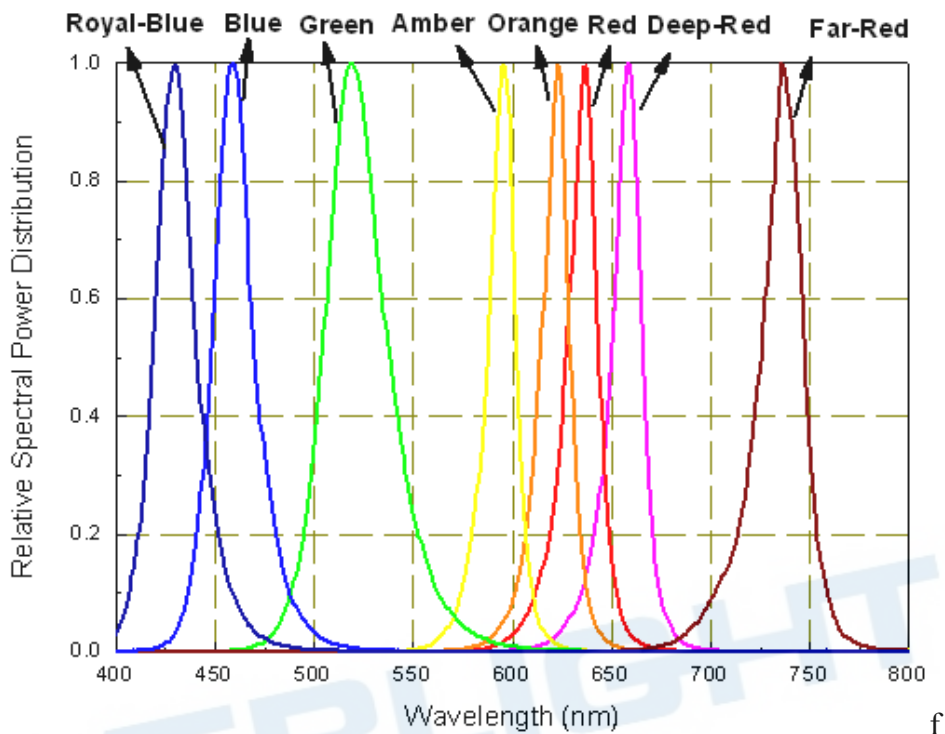

Typical Light Output Characteristic V.S. Thermal Pad Temperature

Cool-White, Neutral-White, Warm-White, Green, Cyan, Blue, Royal-Blue
for 350mA Drive Current

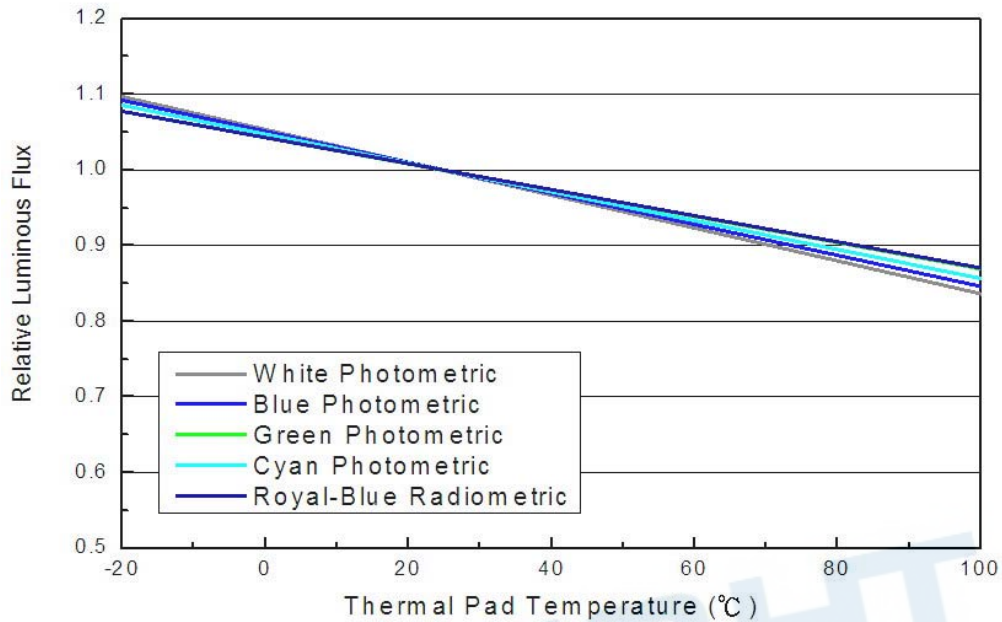

Deep-Red, Red, Orange, Amber for 350mA Drive Current

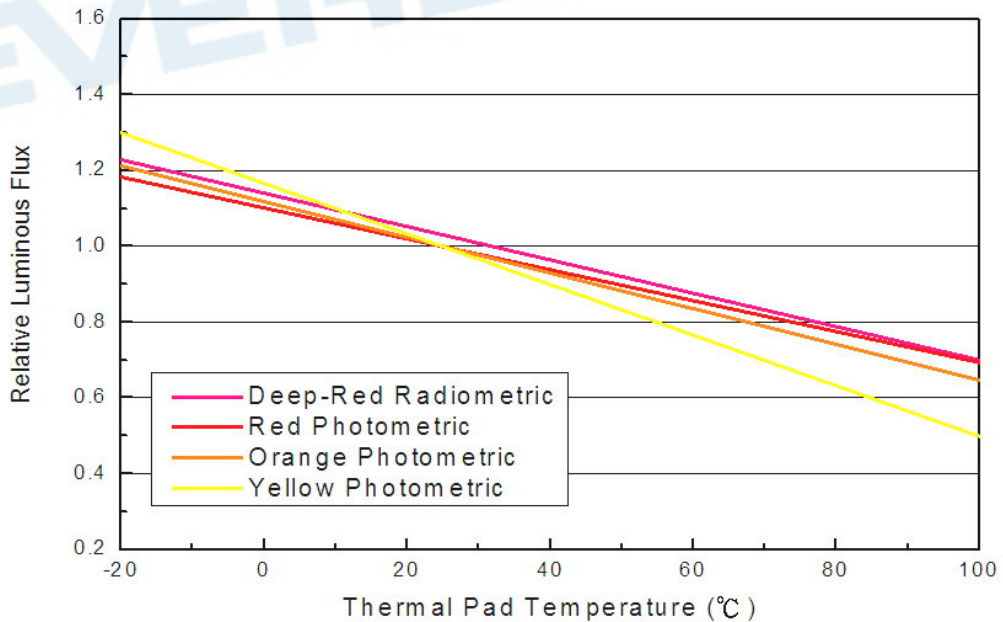

Typical Electrical Characteristics

For Cool-White, Neutral-White, Warm-White, Green, Blue
@ Thermal Pad Temperature = 25°C

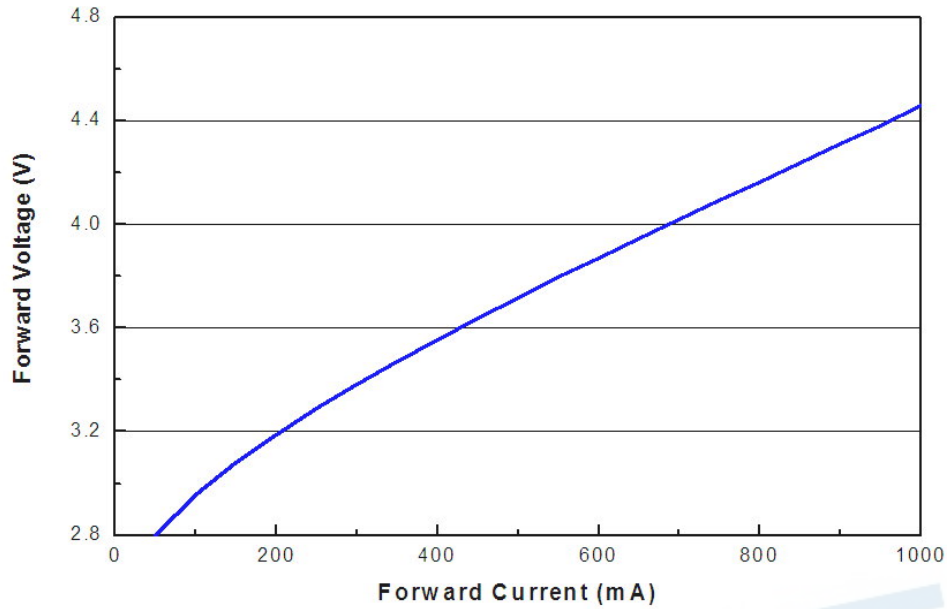

For Red, Orange, Amber,
@ Thermal Pad Temperature = 25°C

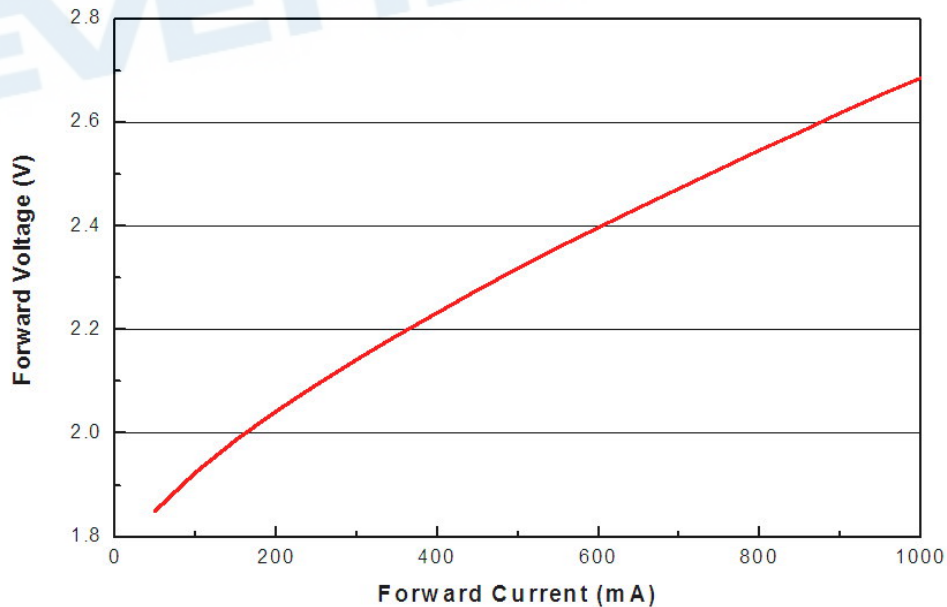

Typical Relative Luminous Flux V.S. Forward Current

For Green, Blue, @ Thermal Pad Temperature = 25°C

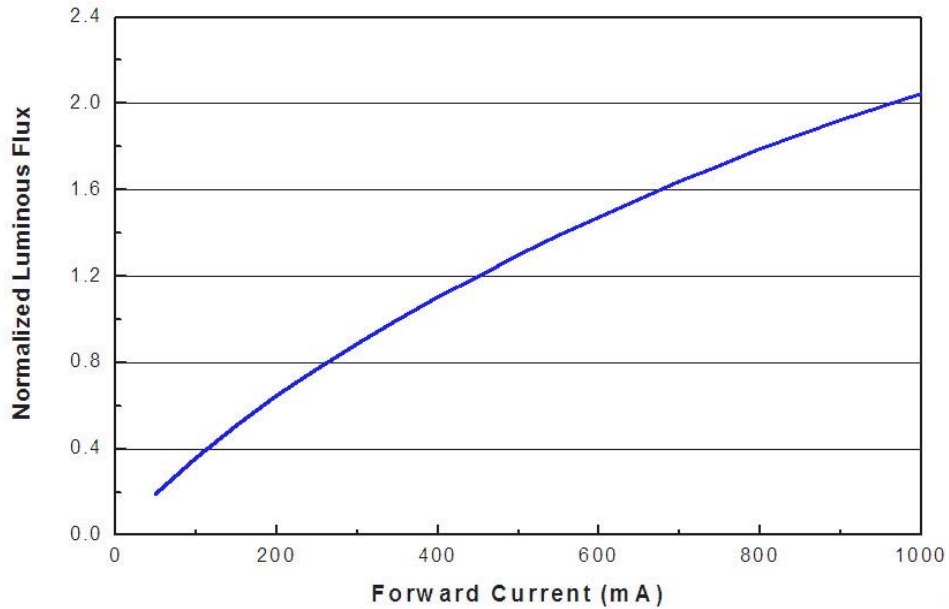

For Red, Orange, Amber,
@ Thermal Pad Temperature = 25°C

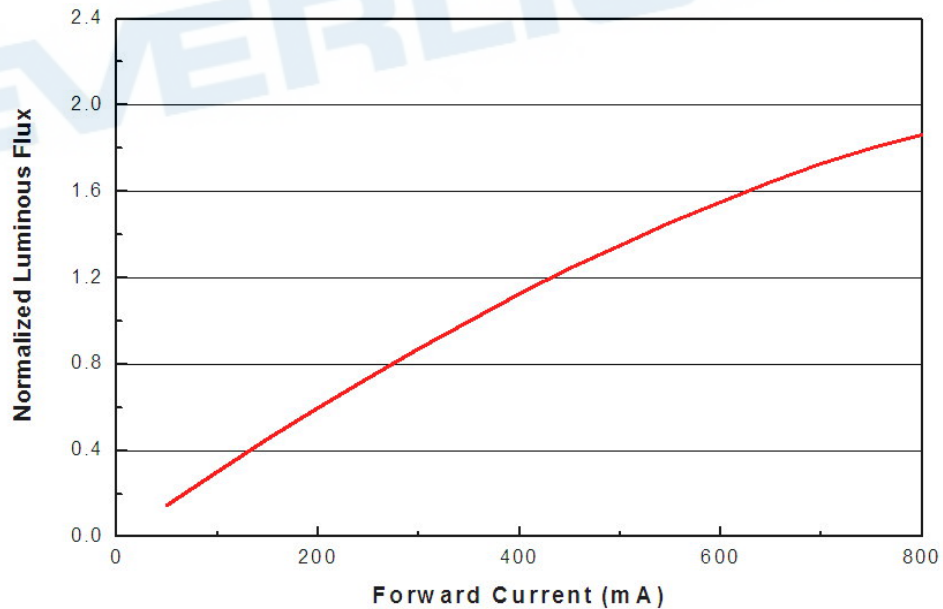

Typical Wavelength Shift Characteristics V.S. Forward Current

For Blue @ Thermal Pad Temperature = 25°C

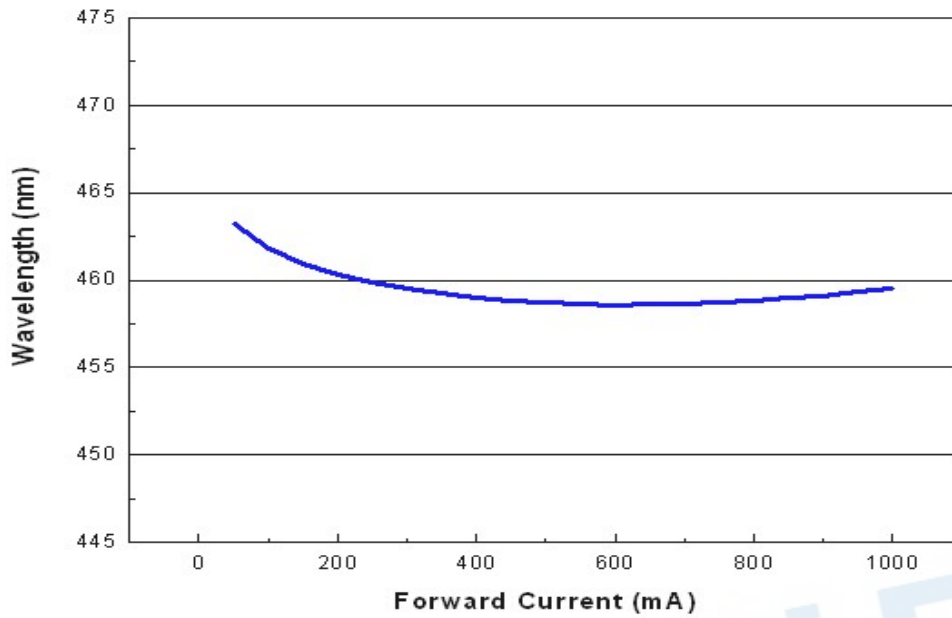

For Green @ Thermal Pad Temperature = 25°C

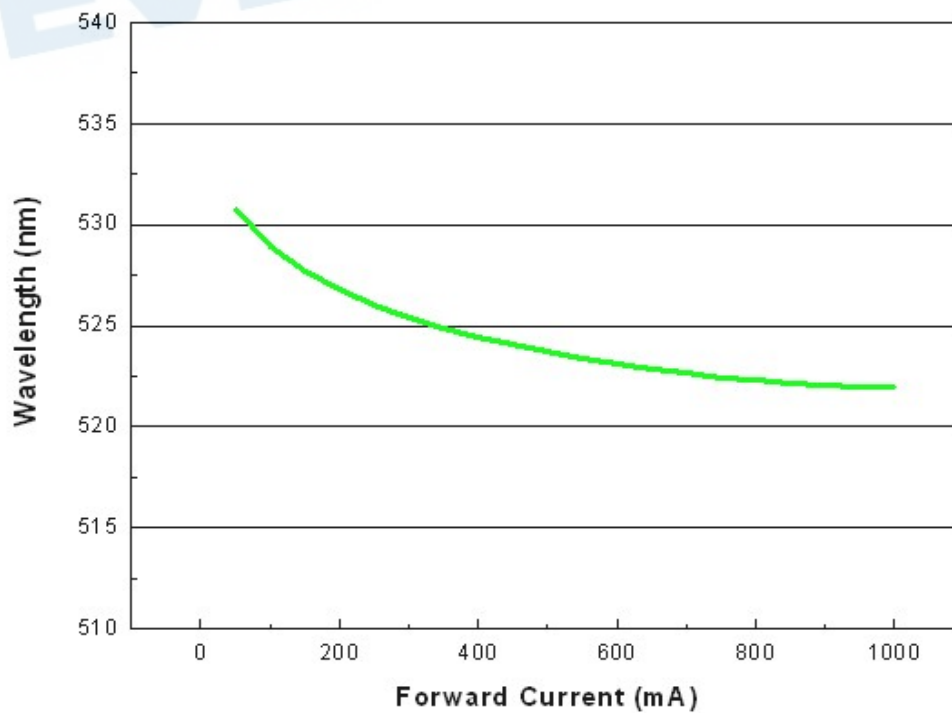

For Red @ Thermal Pad Temperature = 25°C

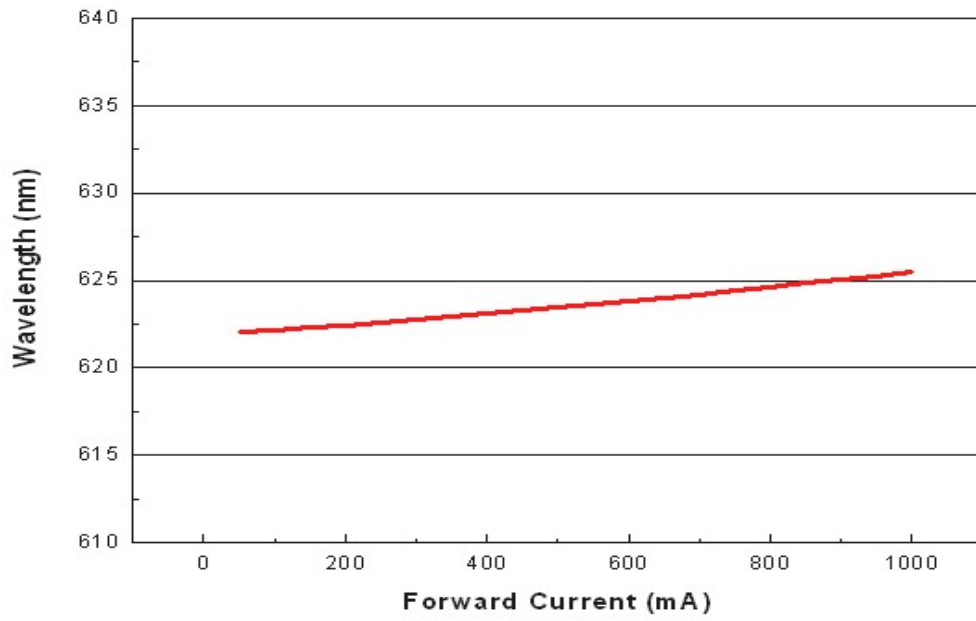

EVERLIGHT

Relative Flux and Forward Voltage V.S. Junction Temperature (IF = 700 mA)

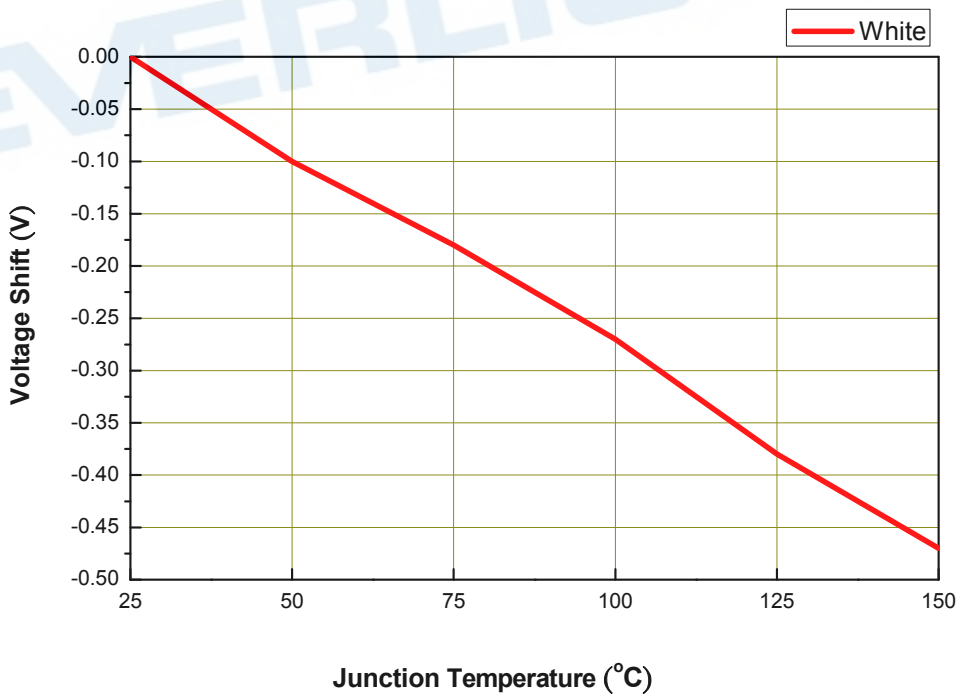
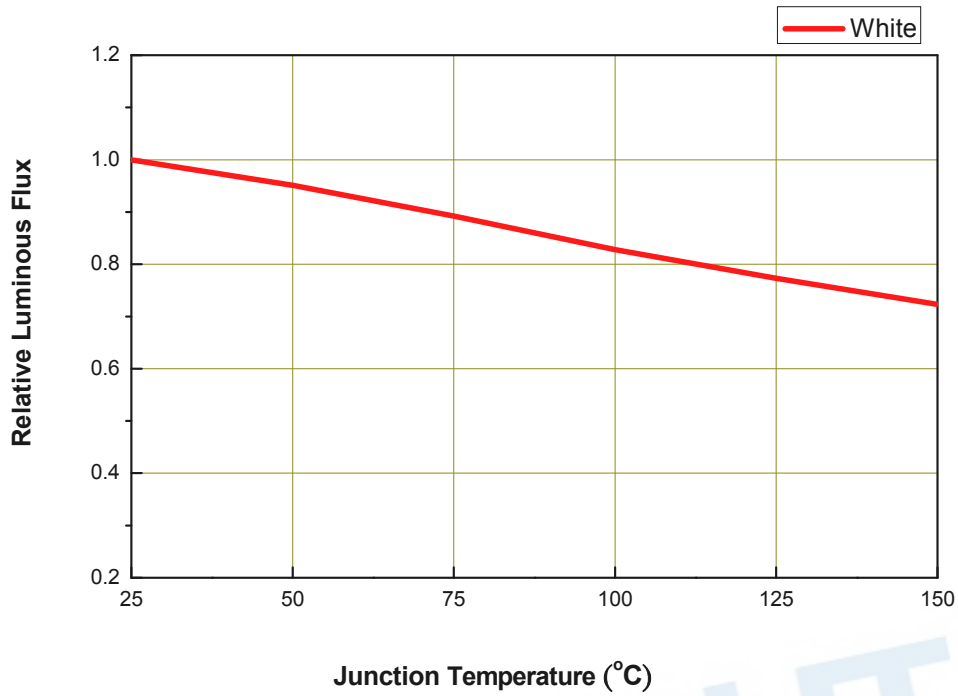

Current Derating Curves

Current Derating Curve for 750mA Drive Current

Cool-White, Neutral-White, Warm-White, Green, Cyan, Blue, Royal-Blue, Far-Red, Deep-Red, Red, Amber, Yellow

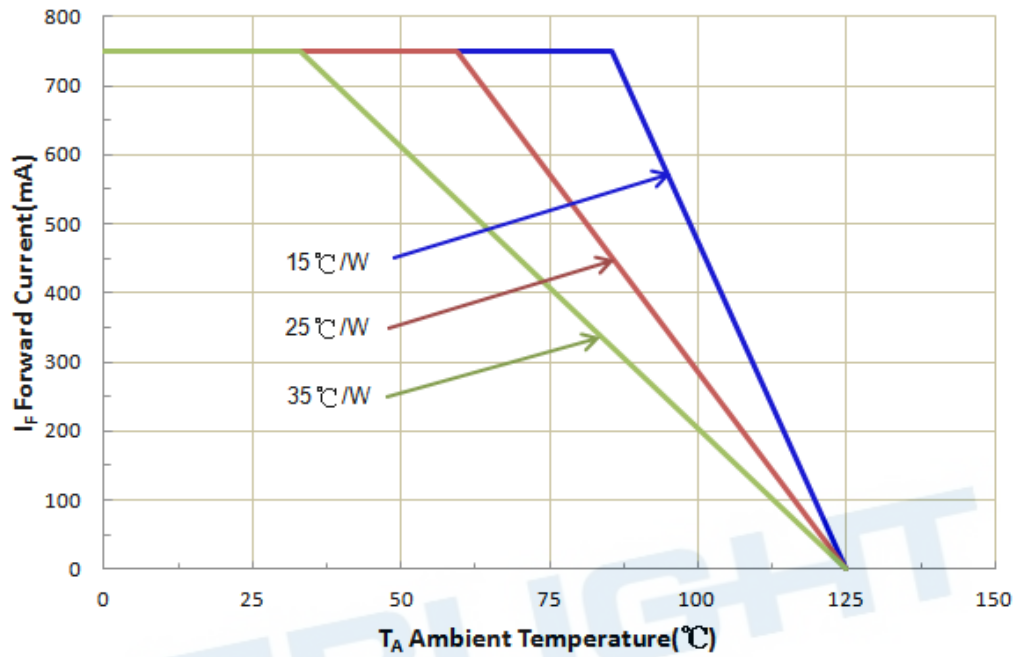

Typical Radiation Patterns

Typical Diagram Characteristics of Radiation for Cool-White, Neutral-White, Warm-White

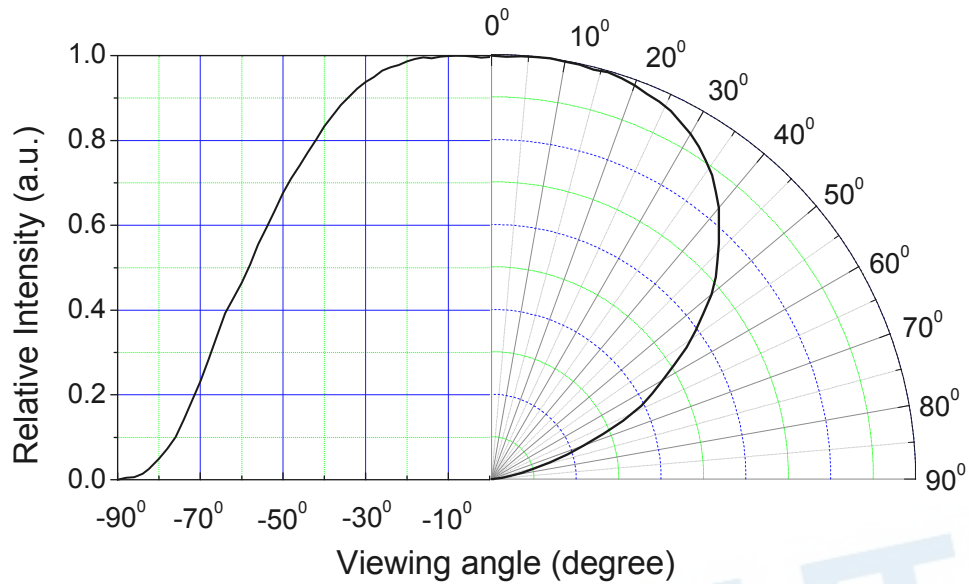

Notes:

1. $2\theta_{1/2}$ is the off axis angle from lamp centerline where the luminous intensity is 1/2 of the peak value.
2. View angle tolerance is $\pm 5^\circ$.

Emitter Reel Packaging

Reel Dimensions

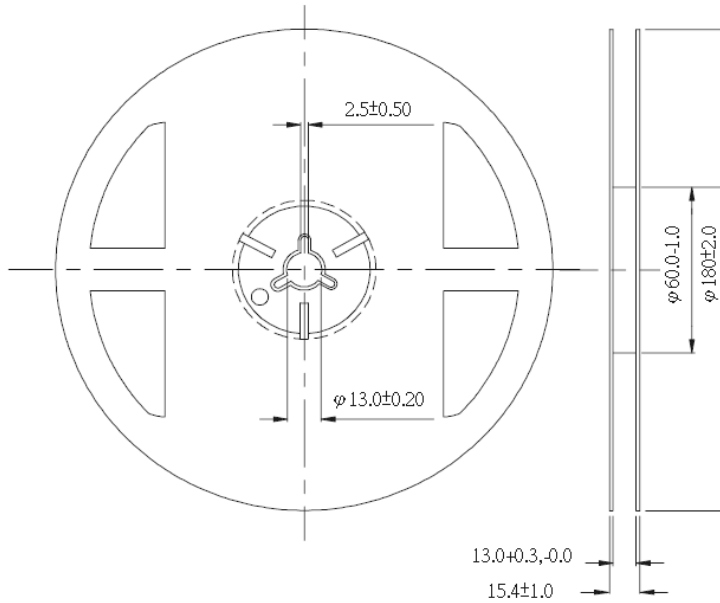

Notes:

1. Dimensions are in millimeters.
2. Tolerances unless mentioned are ± 0.1 mm.

Product Labeling

Label Explanation

- CPN: Customer Specification (when required)
 P/N : Everlight Americas Production Number
 QTY: Packing Quantity
 CAT: Luminous Flux (Brightness) Bin
 HUE: Color Bin
 REF: Forward Voltage Bin
 LOT No: Lot Number
 MADE IN TAIWAN: Production Place

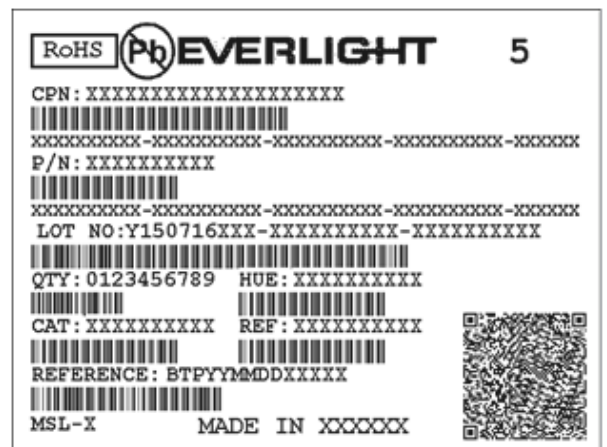

Storage Conditions

- Before the package is opened. The LEDs should be stored at 30°C or less and 85%RH or less after being shipped from Everlight Americas and the storage life limits are 1 year. The LEDs can be stored up to 3 years If in a sealed container with a nitrogen atmosphere and moisture absorbent material.
- After opening the package: The LED's floor life is 1 year under 30°C or less and 60%RH or less. The LED should be soldered with 168hrs (7days) after opening the package. If unused LEDs remain, it should be stored in moisture proof packages.
- If the moisture absorbent material (silica gel) has faded away or the LEDs have exceeded the storage time, baking treatment should be performed using the following conditions. Baking treatment: 60±5°C for 24 hours.

EVERLIGHT

Revision History

Current version: 2016/10/13

Device No: DHE-0002563

Version: 2

| Page | Subjects (major change in previous version) | Date of change |
|--------|---|----------------|
| 3 - 21 | Add drive current & modify product label | 10/13/2016 |
| | | |

EVERLIGHT