

### Infrared Receiver Module IRM-H6XXM3/TR2 Series

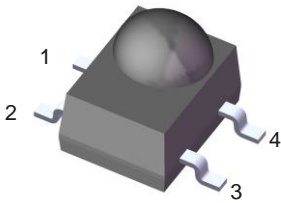

#### Pin Configuration

1. GND
2. GND
3. OUT
4. Vcc

#### Block Diagram

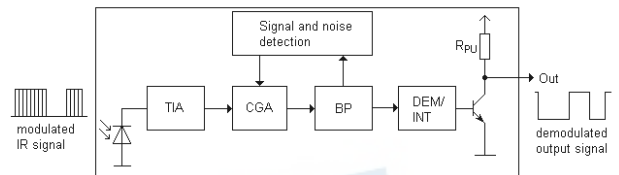

#### Features

- High protection ability against EMI
- Circular lens for improved reception characteristics
- Available for various carrier frequencies
- min burst length: 12 cycles
- min gap length: 16 cycles
- Low operating voltage and low power consumption
- High immunity against ambient light
- High immunity against TFT backlight
- Long reception range
- High sensitivity
- Pb free
- The product itself will remain within RoHS compliant version.
- Compliance with EU REACH
- Compliance Halogen Free (Br < 900 ppm, Cl < 900 ppm, Br+Cl < 1500 ppm)

#### Descriptions

The device is miniature SMD type infrared receiver that has been developed and designed by utilizing the latest IC technology.

The PIN diode and preamplifier are assembled onto a lead frame and molded into a black epoxy package which operates as an IR filter.

The demodulated output signal can directly be decoded by a microprocessor

## Applications

- AV instruments such as Audio, TV, VCR, CD, MD, etc
- Toy applications
- CATV set top boxes
- Multi-media Equipment
- Other devices using IR remote control

## Application Circuit

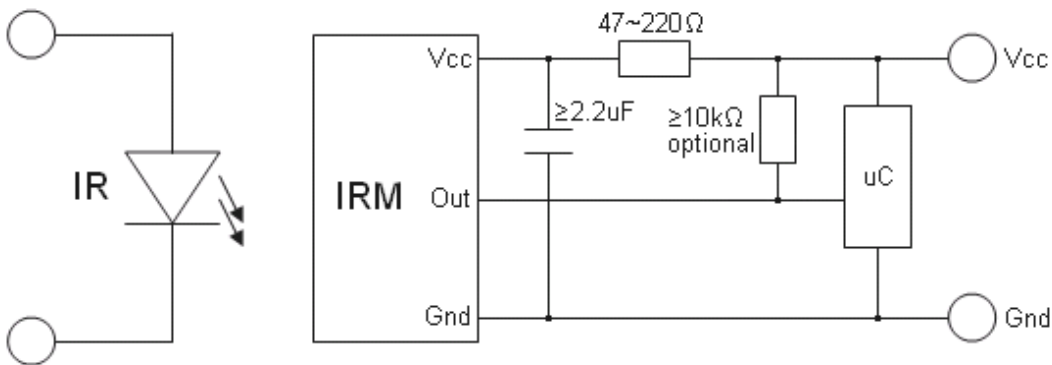

RC Filter should be connected closely between Vcc pin and GND pin.

## Parts Number Table

Model No.	Carrier Frequency
IRM-H636M3/TR2	36 kHz
IRM-H638M3/TR2	38 kHz

### Absolute Maximum Ratings (Ta=25°C) \*1

Parameter	Symbol	Rating	Unit
Supply Voltage	V <sub>cc</sub>	6	V
Operating Temperature	T <sub>opr</sub>	-20 ~ +80	°C
Storage Temperature	T <sub>stg</sub>	-40 ~ +85	°C
Reflow Temperature *2	T <sub>ref</sub>	260	°C

\*1 Stresses in excess of the absolute maximum ratings can cause permanent damage to the device. Functional operation of the device is not implied at these or any other conditions in excess of those given in the operational sections of this document. Exposure to absolute maximum ratings for extended periods of the time can adversely affect reliability.

\*2 Soldering time < 5 seconds

### Electro-Optical Characteristics (Ta=25°C, V<sub>cc</sub>=3V)

Parameter	Symbol	MIN.	TYP.	MAX.	Unit	Condition
Current consumption	I <sub>cc</sub>	---	0.4	0.6	mA	No input signal
Supply voltage	V <sub>cc</sub>	2.7	---	5.5	V	
Peak wavelength	λ <sub>p</sub>	---	940	---	nm	
Reception range	L <sub>0</sub>	8	---	---	m	See chapter 'Test method' *3
	L <sub>45</sub>	5	---	---		
Half angle(horizontal)	φ <sub>h</sub>	---	±45	---	deg	
Half angle(vertical)	φ <sub>v</sub>	---	±45	---	deg	
High level pulse width	T <sub>H</sub>	400	---	800	μs	Test signal according to figure 1 *4
Low level pulse width	T <sub>L</sub>	400	---	800	μs	
High level output voltage	V <sub>OH</sub>	V <sub>cc</sub> -0.4	---	---	V	I <sub>SOURCE</sub> ≤ 1μA
Low level output voltage	V <sub>OL</sub>	---	0.2	0.5	V	I <sub>SINK</sub> ≤ 2mA

\*3 The ray receiving surface at a vertex and relation to the ray axis in the range of θ=0° and θ=45°.

\*4 A range from 30cm to the arrival distance. Average value of 50 pulses.

## Test Method

The specified electro-optical characteristic is satisfied under the following Conditions:

1. Measurement environment  
A place without extreme light reflected
2. External light  
Ordinary white fluorescent lamps (Light source temperature 2856°K,  $E_e \leq 10\text{Lux}$ ) without high frequency modulation
3. Standard transmitter  
The test transmitter is calibrated by using the circuit shown in figure 2. The radiation intensity of the transmitter is adjusted until  $V_o=400\text{mVp-p}$ . Both the test transmitter and the photo diode have the peak wavelength of 940nm. The photo diode for calibration is PD438B ( $\lambda_p=940\text{nm}$ ,  $V_r=5\text{V}$ ).
4. Measuring system According to the measuring system shown in Fig.-3

Fig.-1 Transmitter Wave Form

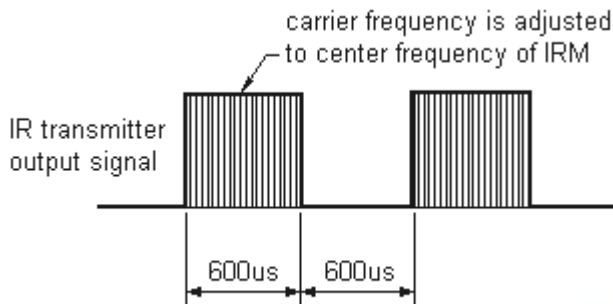

D.U.T output Pulse

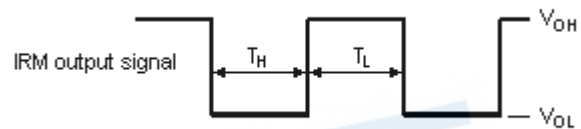

Fig.-2 Standard transmitter calibration

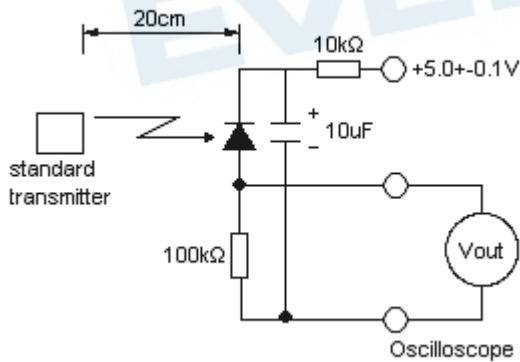
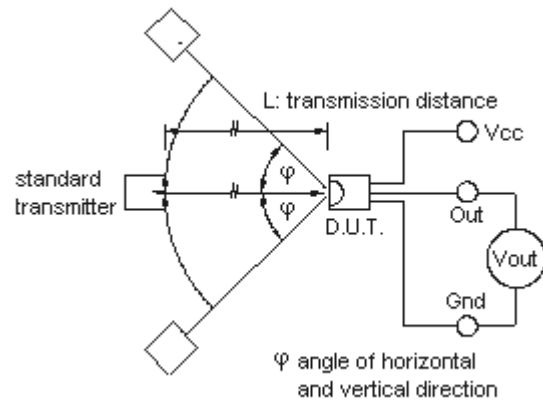

Fig.-3 Measuring System



Typical Performance Curves

Fig.4 Relative Responsibility vs. Wavelength

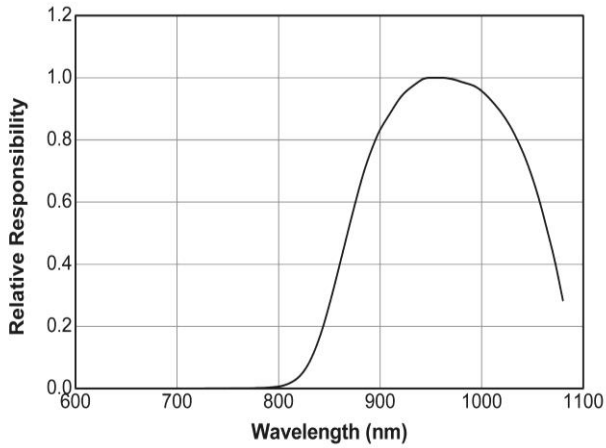

Fig.-5 Relative Transmission Distance vs. Direction

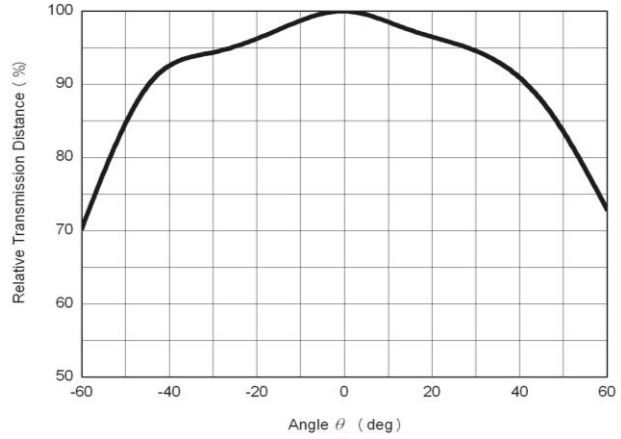

Fig.6 Variation Output Pulse Width vs. Distance

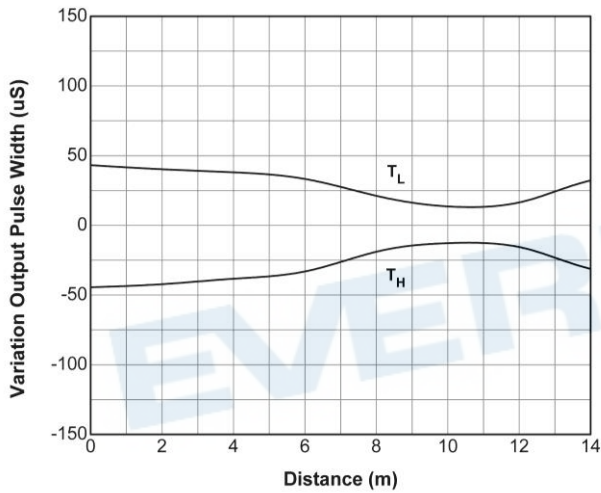

Fig.7 Relative Sensitivity vs. Supply Voltage

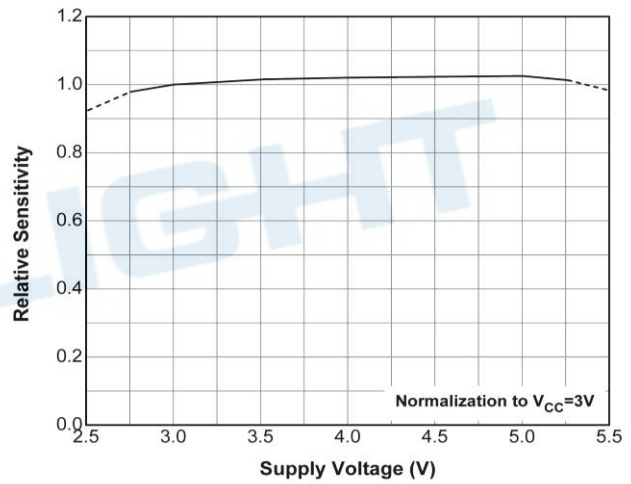
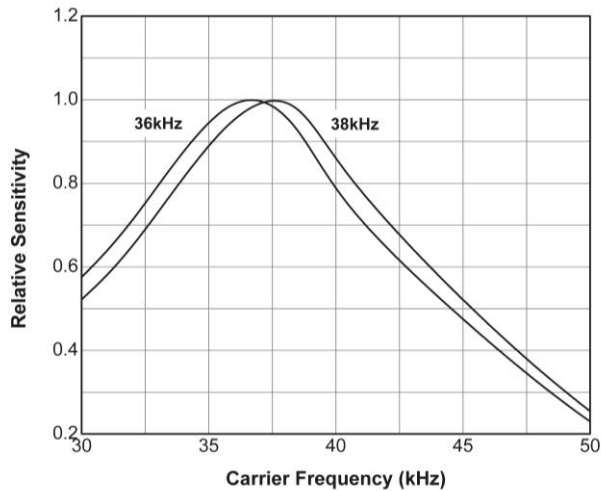
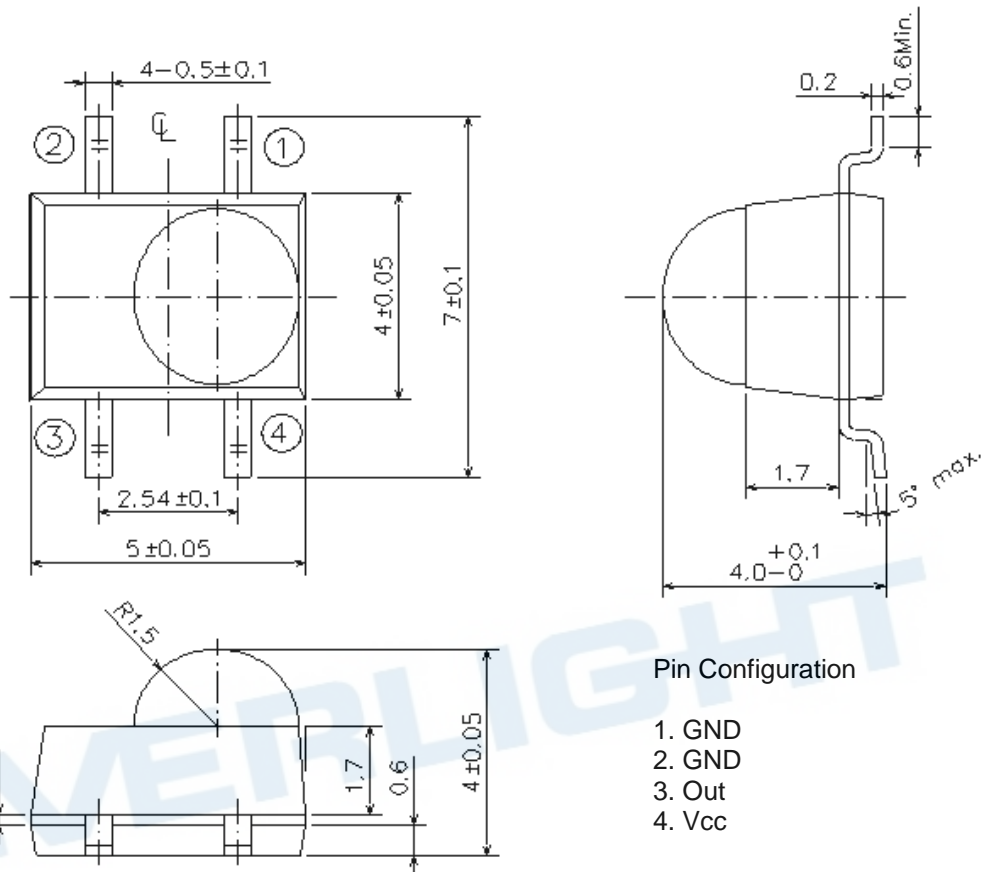

Fig.8 Relative Sensitivity vs. Carrier Frequency



**Package Dimensions**  
(Dimensions in mm)



Note: Tolerances unless otherwise mentioned  $\pm 0.5$ mm.

**Recommend soldering patterns**

The following soldering patterns are recommended for reflow-soldering

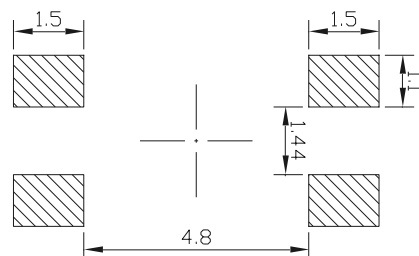

Notice: Suggested pad dimension is just for reference only.  
Please modify the pad dimension based on individual need.

## Code information

Protocol	Suitable	Protocol	Suitable
JVC	Yes	Sharp	Yes
Matsushita	Yes	Sony 12 bit <sup>2)</sup>	Yes
Mitsubishi	No	Sony 15 bit	No
NEC	Yes	Sony 20 bit	No
RC5	Yes	Toshiba	Yes
RC6 <sup>1)</sup>	Yes	Continuous Code	No
RCA	No		

1) Best choice depends on RC6 mode. If data low time is below 22ms, M2 is the best choice, otherwise M3.

2) If only Sony 12 bit version is used, M3 is recommended otherwise M2 is the best choice.

## Device Marking

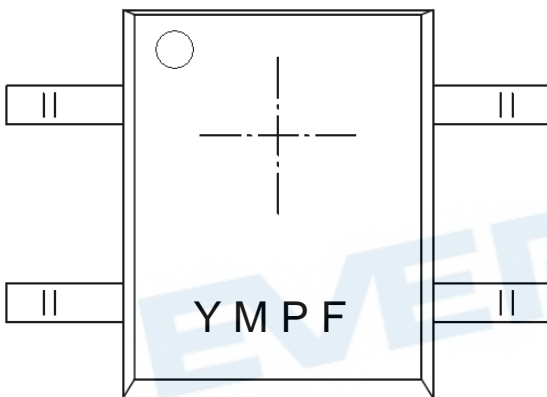

### Notes

- Y denotes Years code
- M denotes Month code
- P denotes Device number
- F denotes Carrier frequency

## Tape & Reel Packing Specifications

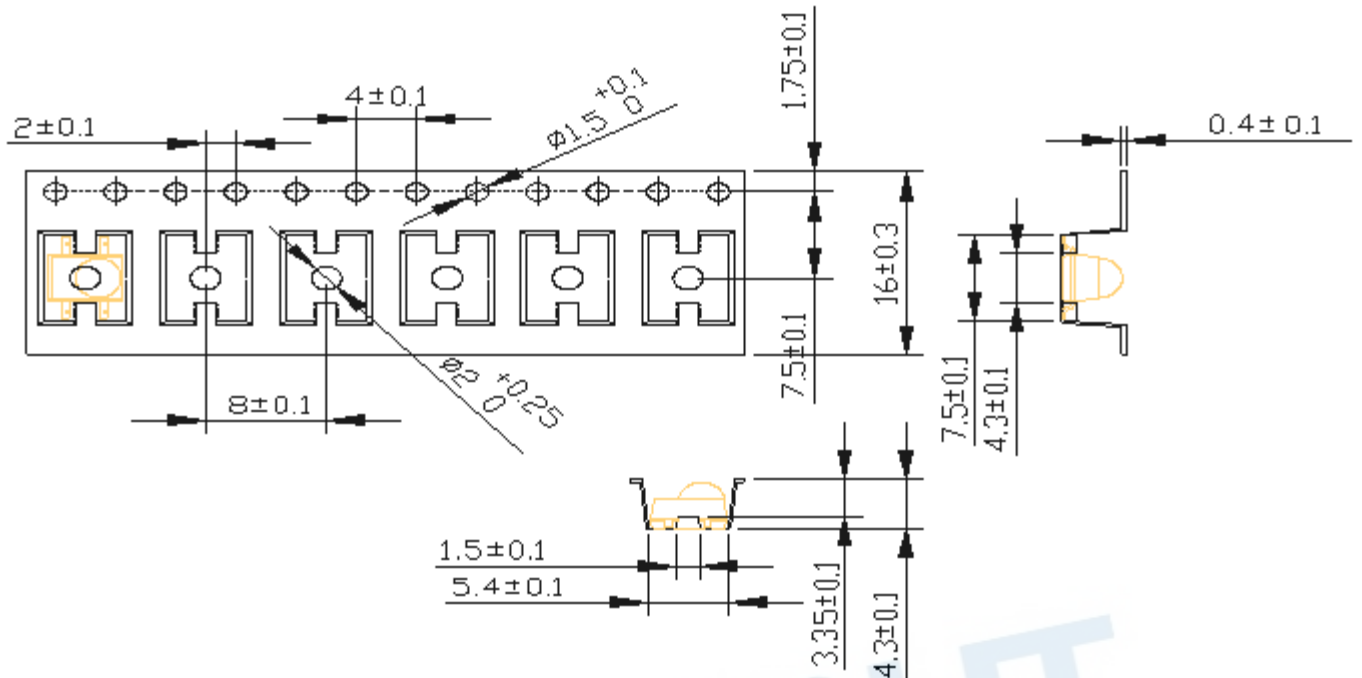

## Packing Quantity

- 1500 pcs / Reel
- 3 Reels / Box
- 5 Boxes / Carton

## Recommended method of storage

The following are general recommendations for moisture sensitive level (MSL) 4 storage and use:

1. Shelf life in sealed bag from the bag seal date: 12 months at  $< 40\text{ }^{\circ}\text{C}$  and  $< 90\%$  relative humidity (RH)
2. After bag is opened, devices that will be subjected to reflow solder or other high temperature process must be mounted within 72 hours of factory conditions  $< 30\text{ }^{\circ}\text{C}/60\%$ RH.
3. If the moisture absorbent material (silica gel) has faded away or the IRM has exceeded the storage time. Baking treatment is required, refer to IPC/JEDEC J-STD-033 for bake procedure or recommend the conditions:  $60 \pm 5\text{ }^{\circ}\text{C}$  for 96 hours.

## ESD Precaution

Proper storage and hand procedures should be followed to prevent ESD damage to the devices especially when they are removed from the Anti-static bag. Electro-Static Sensitive Devices warning labels are on the packing.

## Solder Reflow Temperature Profile

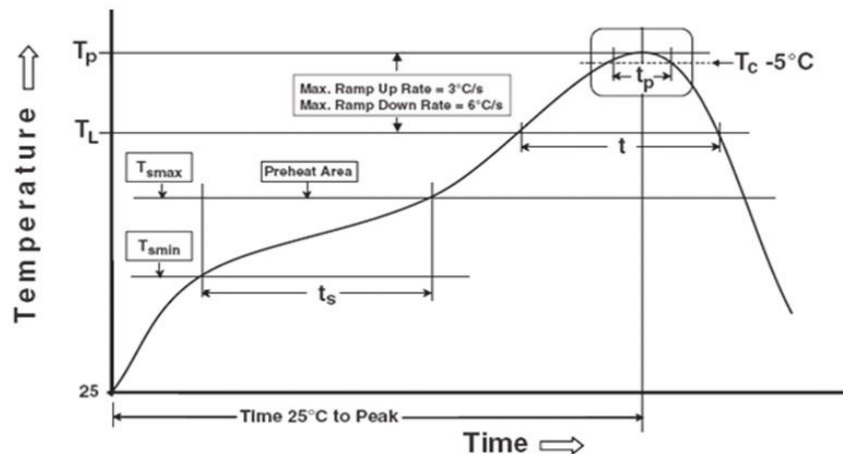

Note:

Reference: IPC/JEDEC J-STD-020D

### Preheat

Temperature min ( $T_{smin}$ )	150 °C
Temperature max ( $T_{smax}$ )	200°C
Time ( $T_{smin}$ to $T_{smax}$ ) ( $t_s$ )	60-120 seconds
Average ramp-up rate ( $T_{smax}$ to $T_p$ )	3 °C/second max

### Other

Liquidus Temperature ( $T_L$ )	217 °C
Time above Liquidus Temperature ( $t_L$ )	60-100sec
Peak Temperature ( $T_p$ )	260°C
Time within 5 °C of Actual Peak Temperature: $T_p - 5^\circ\text{C}$	30 s
Ramp- Down Rate from Peak Temperature	6°C /second max.
Time 25°C to peak temperature	8 minutes max.
Reflow times	2 times

Note:

1. Suggest that reflow soldering should not be done more than two times.
2. When soldering, do not put stress on the IRM device during heating.
3. After soldering, do not warp the circuit board.

## DISCLAIMER

1. EVERLIGHT reserves the right(s) on the adjustment of product material mix for the specification.
2. The product meets EVERLIGHT published specification for a period of twelve (12) months from date of shipment.
3. The graphs shown in this datasheet are representing typical data only and do not show guaranteed values.
4. When using this product, please observe the absolute maximum ratings and the instructions for using outlined in these specification sheets. EVERLIGHT assumes no responsibility for any damage resulting from the use of the product which does not comply with the absolute maximum ratings and the instructions included in these specification sheets.
5. These specification sheets include materials protected under copyright of EVERLIGHT. Reproduction in any form is prohibited without obtaining EVERLIGHT's prior consent.
6. This product is not intended to be used for military, aircraft, automotive, medical, life sustaining or life saving applications or any other application which can result in human injury or death. Please contact authorized Everlight sales agent for special application request.

EVERLIGHT