

# 4 PIN DIP VERY HIGH ISOLATION VOLTAGE PHOTOCOUPLER

CNY64S series

## Features

- High Voltage  
BV<sub>CEO</sub>=80V (min.)
- Operating temperature up to +85°C
- High isolation voltage between input and output  
V<sub>IO<sub>TM</sub></sub> = 8200 V perk for CNY64  
V<sub>IO<sub>TM</sub></sub> = 10000 V perk for CNY64-V
- Rated recurring peak voltage (repetitive)  
V<sub>IORM</sub> = 2200 V
- Creepage current resistance according to VDE 0303/IEC 60112  
comparative tracking index: CTI ≥ 200
- Thickness through insulation ≥ 3mm
- Pb free and RoHS compliant.
- CUL approved (No. E214129)
- VDE approved (No. 40027351)
- FIMKO approved (No. 25464)

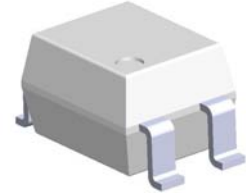

## Description

The CNY64S series contains an infrared emitting diode optically coupled to a phototransistor.

These device is packaged in an 4-pin SMD package and providing a distance between input and output for highest safety requirement of >3mm.

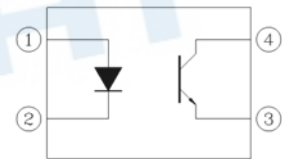

1. Anode
2. Cathode
3. Emitter
4. Collector

## Applications

- Switch mode power supply
- Line receiver
- Computer peripheral interface
- Microprocessor system interface
- Circuits for safe protective separation against electrical shock according to safety class II (reinforced isolation):
  - for appl. class I - IV at mains voltage ≤ 300 V
  - for appl. class I - IV at mains voltage ≤ 600 V
  - for appl. class I - III at mains voltage ≤ 1000 V
 according to DIN EN 60747-5-5

# 4 PIN DIP VERY HIGH ISOLATION VOLTAGE PHOTOCOUPLER

CNY64S series

## Absolute Maximum Ratings ( $T_a=25^{\circ}\text{C}$ )

Parameter		Symbol	Rating	Unit
Input	Forward current	$I_F$	75	mA
	Peak forward current (<10 $\mu\text{s}$ )	$I_{FM}$	1.5	A
	Reverse voltage	$V_R$	5	V
	Power dissipation	$P_D$	120	mW
Output	Collector current	$I_C$	50	mA
	Collector power dissipation	$P_C$	150	mW
	Collector-Emitter voltage	$V_{CEO}$	80	V
	Emitter-Collector voltage	$V_{ECO}$	7	V
Total power dissipation		$P_{tot}$	250	mW
Isolation voltage <sup>*1</sup>		$V_{iso}$	8200	Vrms
Operating temperature		$T_{opr}$	-55~+85	$^{\circ}\text{C}$
Storage temperature		$T_{stg}$	-55~+100	$^{\circ}\text{C}$
Soldering temperature <sup>*2</sup>		$T_{sol}$	260	$^{\circ}\text{C}$

### Notes

\*1 AC for 1 minute, R.H.= 40 ~ 60% R.H. In this test, pins 1 & 2 are shorted together, and pins 3 & 4 are shorted together.

\*2 2mm from case, <10 seconds.

# 4 PIN DIP VERY HIGH ISOLATION VOLTAGE PHOTOCOUPLER

CNY64S series

## Electrical Characteristics (T<sub>a</sub>=25°C unless specified otherwise)

### Input

Parameter	Symbol	Min.	Typ.*	Max.	Unit	Condition
Forward voltage	V <sub>F</sub>	-	1.6	2.0	V	I <sub>F</sub> = 50mA
Reverse current	I <sub>R</sub>	-	-	10	μA	V <sub>R</sub> = 5V
Input capacitance	C <sub>in</sub>	-	-	100	pF	V = 0, f = 1MHz

### Output

Parameter	Symbol	Min.	Typ.*	Max.	Unit	Condition
Collector-Emitter dark current	I <sub>CEO</sub>	-	-	200	nA	V <sub>CE</sub> = 20V, I <sub>F</sub> =0mA
Collector-Emitter breakdown voltage	BV <sub>CEO</sub>	80	-	-	V	I <sub>C</sub> = 1mA
Emitter-Collector breakdown voltage	BV <sub>ECO</sub>	7	-	-	V	I <sub>E</sub> = 0.1mA
Collector-Emitter capacitance	C <sub>CE</sub>	-	-	50	pF	V <sub>CE</sub> = 0V, f = 1MHz

### Transfer Characteristics

Parameter	Symbol	Min.	Typ.*	Max.	Unit	Condition
Current Transfer Ratio	CNY64	50	-	300	%	I <sub>F</sub> = 5mA, V <sub>CE</sub> = 5V
	CNY64A	63	-	125		
	CNY64B	100	-	200		
Collector-emitter saturation voltage	V <sub>CE(sat)</sub>	-	-	0.3	V	I <sub>F</sub> = 10mA, I <sub>C</sub> = 1mA
Coupling capacitance	C <sub>IO</sub>	-	0.3	-	pF	f=1MHz
Isolation resistance	R <sub>IO</sub>	10 <sup>11</sup>	-	-	Ω	V <sub>IO</sub> = 500Vdc
Turn-on time	T <sub>on</sub>	-	6	18	μs	V <sub>CC</sub> = 5V, I <sub>C</sub> = 5mA, R <sub>L</sub> = 100Ω
Turn-off time	T <sub>off</sub>	-	7	18		
Rise time	t <sub>r</sub>	-	3	18		V <sub>CC</sub> = 5V, I <sub>C</sub> = 5mA, R <sub>L</sub> = 100Ω
Fall time	t <sub>f</sub>	-	5	18		

\* Typical values at T<sub>a</sub> = 25°C

# 4 PIN DIP VERY HIGH ISOLATION VOLTAGE PHOTOCOUPLER

CNY64S series

## Typical Performance Curves

Figure 1. Forward Current vs. Forward Voltage

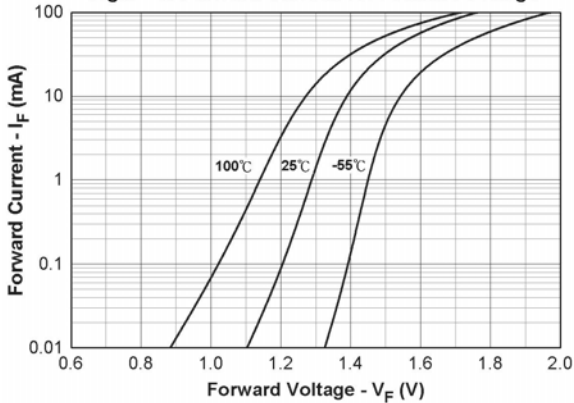

Figure 2. Normalized Current Transfer Ratio vs. Forward Current

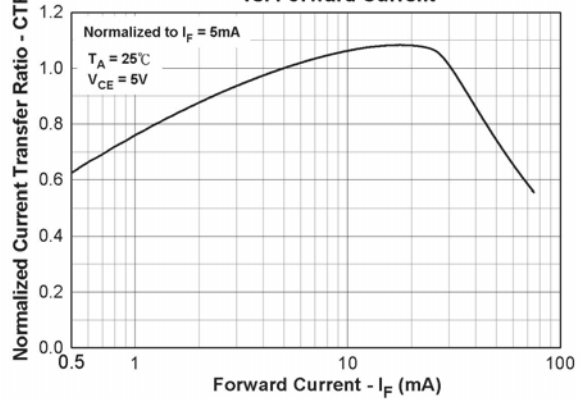

Figure 3. Normalized Current Transfer Ratio vs. Ambient Temperature

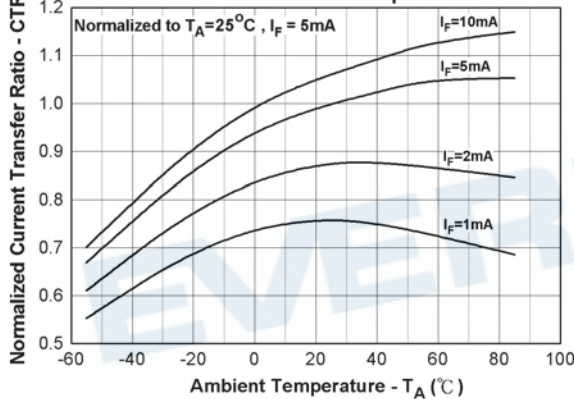

Figure 4. Collector Current vs. Forward Current

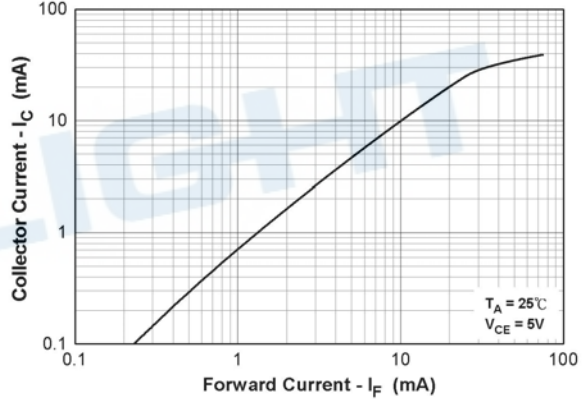

Figure 5. Collector-Emitter Saturation Voltage vs. Collector Current

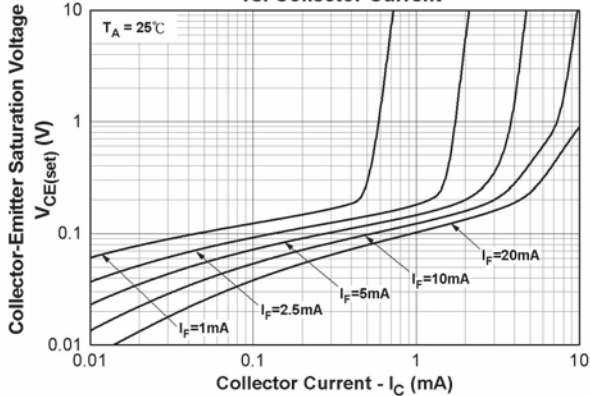
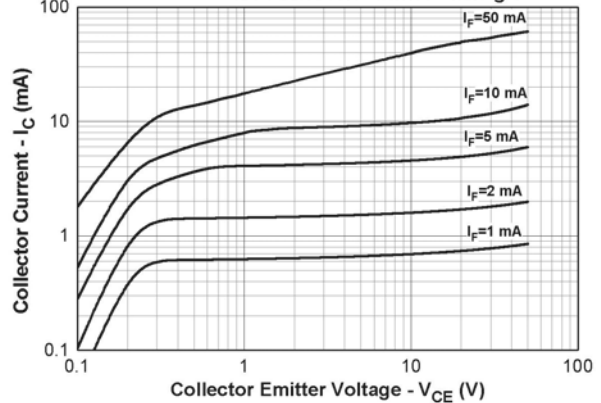

Figure 6. Collector Current vs. Collector Emitter Voltage



# 4 PIN DIP VERY HIGH ISOLATION VOLTAGE PHOTOCOUPLER

CNY64S series

Figure.7 Collector Dark Current vs. Ambient Temperature

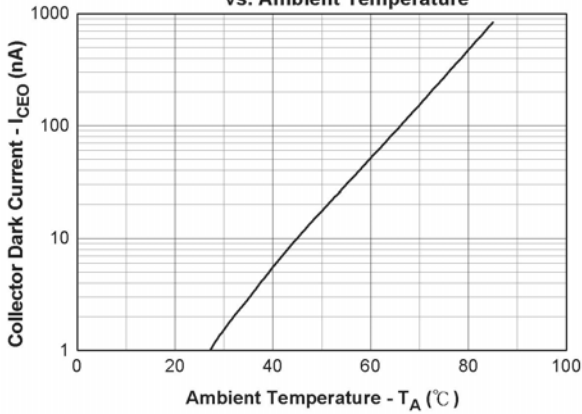

Figure 8. Turn on/off Time vs. Forward Current

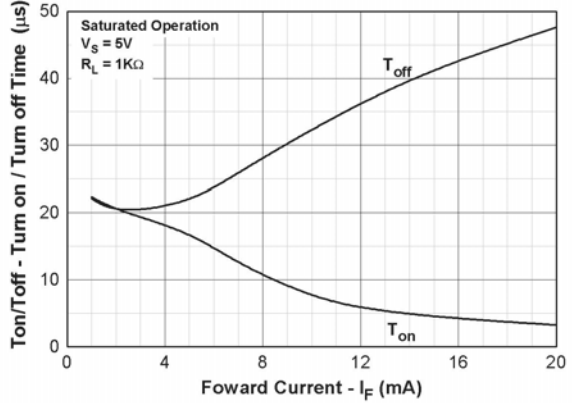

Figure 9. Turn on/off Time vs. Collector Current

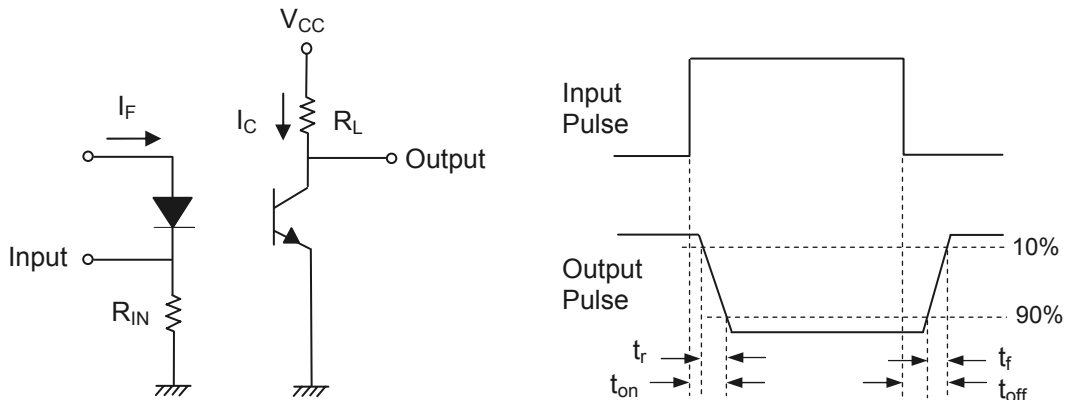
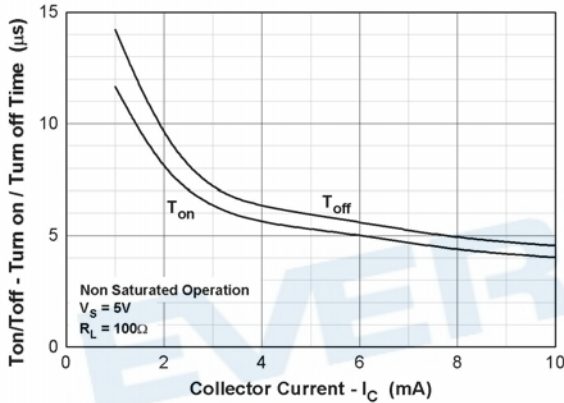

Figure 10. Switching Time Test Circuit & Waveforms



LIGHTING FOREVER

# 4 PIN DIP VERY HIGH ISOLATION VOLTAGE PHOTOCOUPLER

## CNY64S series

### Order Information

Part Number

# CNY64SX-V

Note

X = CTR rank option (A, B or none)

V = VDE safety (optional)

Option	Description	Packing quantity
CNY64S	Standard	60 units per tube
CNY64S-V	Standard + VDE	60 units per tube
CNY64S(TA)	Standard	500 units per tube

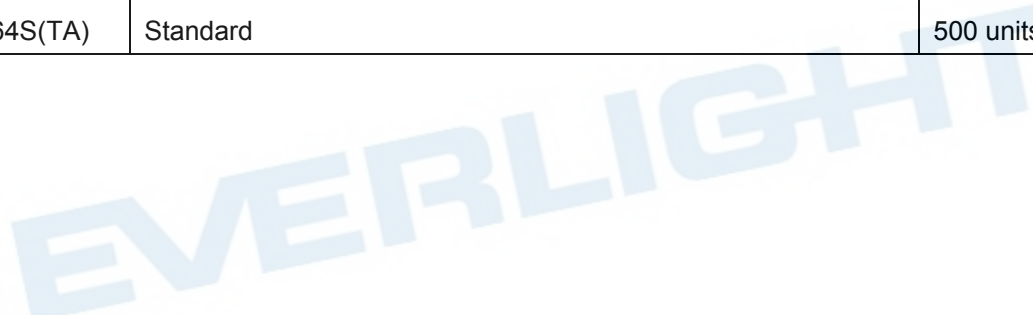



LIGHTING FOREVER

# 4 PIN DIP VERY HIGH ISOLATION VOLTAGE PHOTOCOUPLER

## CNY64S series

### Package Drawings

(Dimensions in mm)

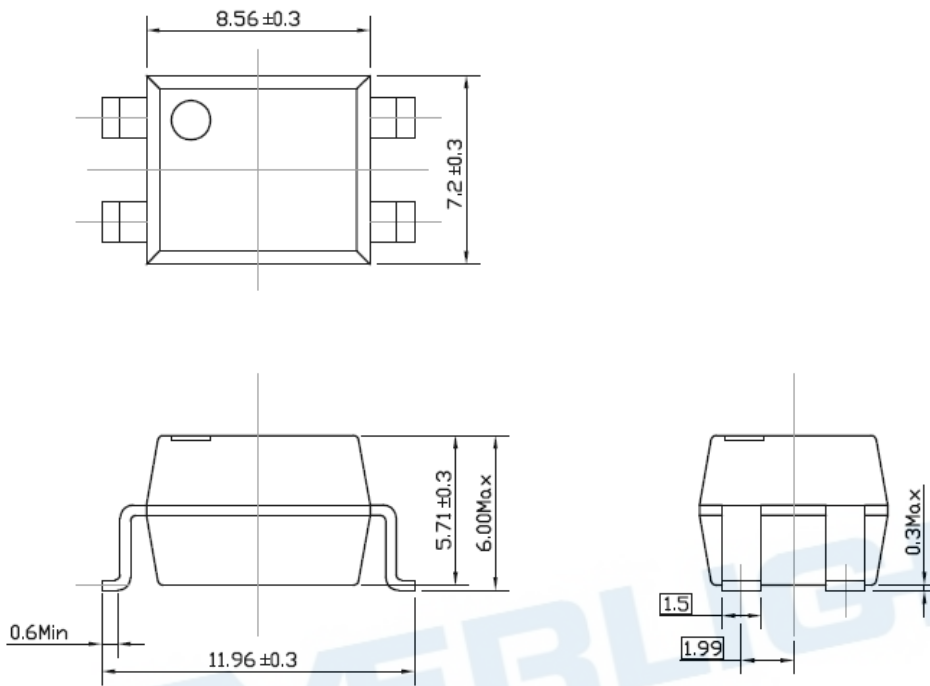

### Recommended pad layout for surface mount leadform

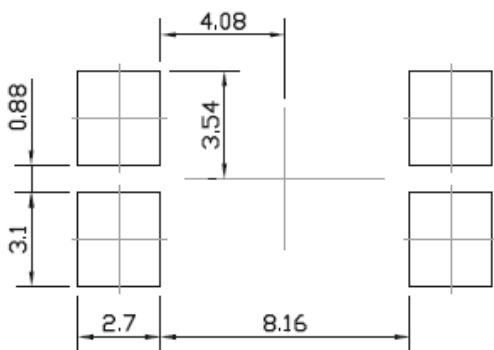



LIGHTING FOREVER

# 4 PIN DIP VERY HIGH ISOLATION VOLTAGE PHOTOCOUPLER

## CNY64S series

### Device Marking



### Notes

- EL denotes Everlight
- CNY64 denotes Part no.
- R denotes CTR rank (A or B)
- Y denotes 1 digit Year code
- WW denotes 2 digit Week code
- V denotes VDE safety (optional)

EVERLIGHT

# 4 PIN DIP VERY HIGH ISOLATION VOLTAGE PHOTOCOUPLER

CNY64S series

## Tape & Reel Packing Specifications

### Option TA

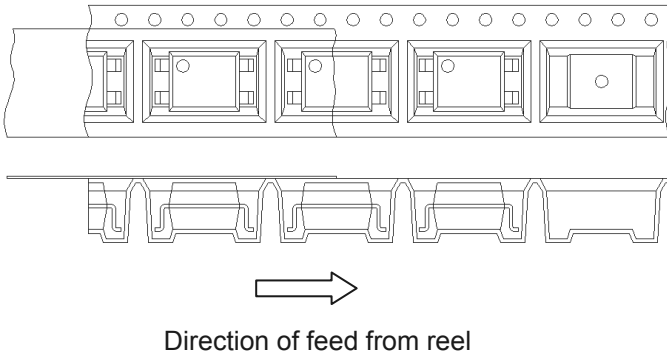

### Tape dimensions

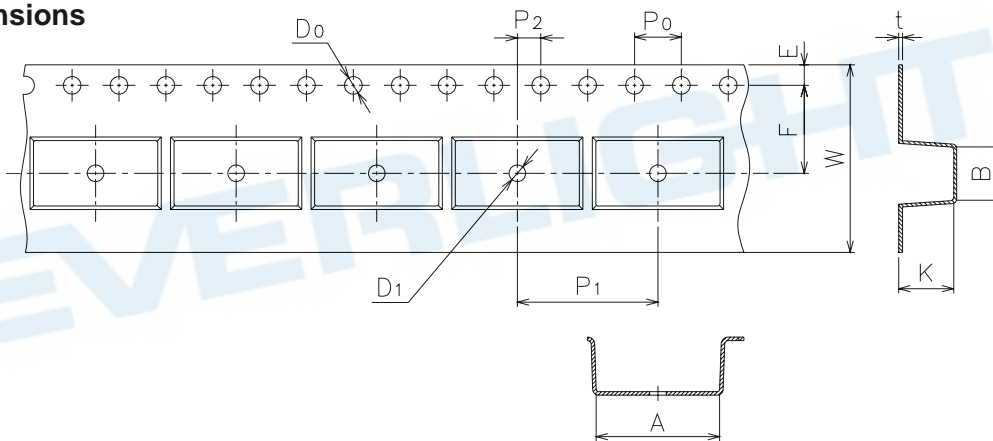

Dimension No.	<b>A</b>	<b>B</b>	<b>Do</b>	<b>D1</b>	<b>E</b>	<b>F</b>
Dimension(mm)	12.6±0.1	6.6±0.1	1.5+0.1/-0	1.5±0.1	1.75±0.1	7.5±0.1
Dimension No.	<b>Po</b>	<b>P1</b>	<b>P2</b>	<b>t</b>	<b>W</b>	<b>K</b>
Dimension(mm)	4.0±0.1	16.0±0.1	2.0±0.1	0.5±0.05	16.0±0.3	7.31±0.1



LIGHTING FOREVER

# 4 PIN DIP VERY HIGH ISOLATION VOLTAGE PHOTOCOUPLER

## CNY64S series

### Solder Reflow Temperature Profile

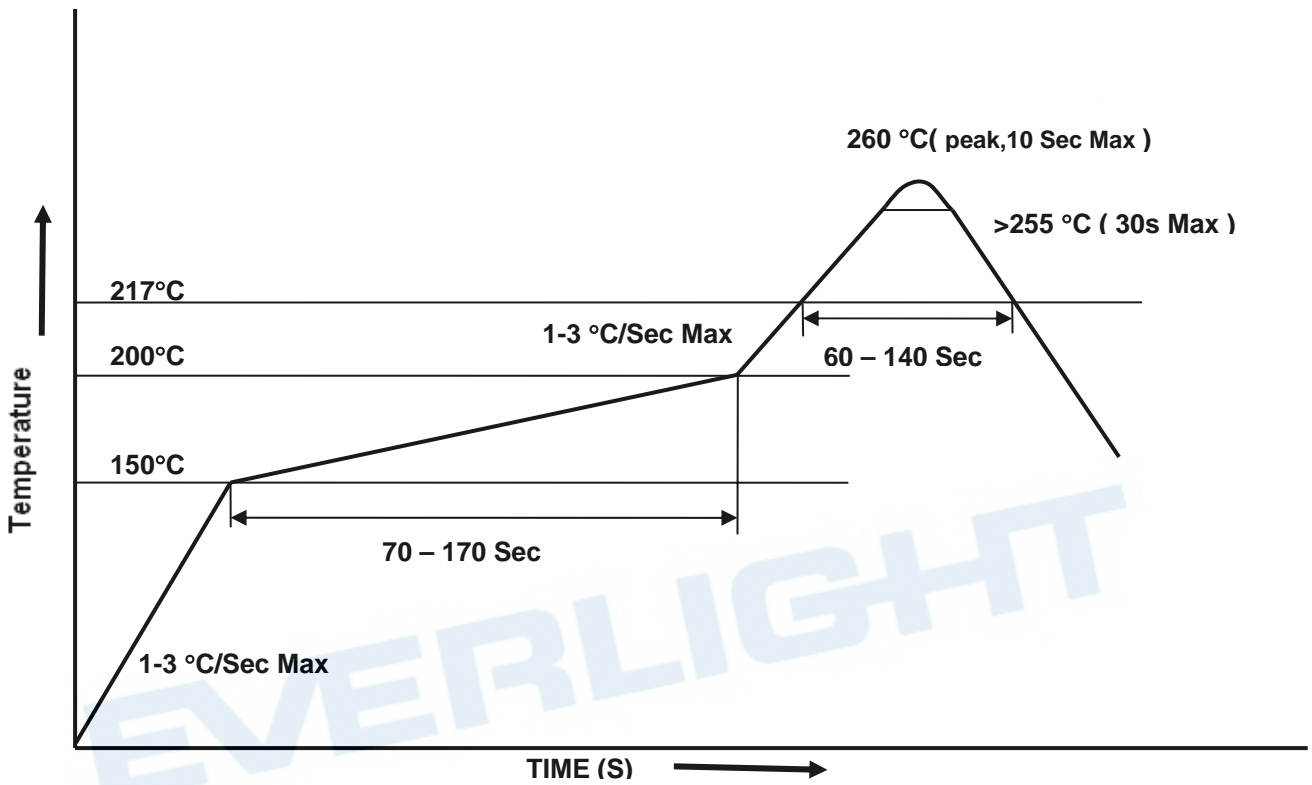



# 4 PIN DIP VERY HIGH ISOLATION VOLTAGE PHOTOCOUPLER

CNY64S series

---

## DISCLAIMER

1. The specifications in this datasheet may be changed without notice. EVERLIGHT reserves the authority on material change for above specification.
2. When using this product, please observe the absolute maximum ratings and the instructions for use as outlined in this datasheet. EVERLIGHT assumes no responsibility for any damage resulting from use of the product which does not comply with the absolute maximum ratings and the instructions included in this datasheet.
3. These specification sheets include materials protected under copyright of EVERLIGHT. Reproduction in any form is prohibited without the specific consent of EVERLIGHT.

EVERLIGHT