

SMD ▪ Side View LEDs

99-218/GHC-YS1T2B17Y/2G



Features

- Lead frame package with individual 2 pins.
- Wide viewing angle.
- Soldering methods: IR reflow soldering.
- ESD protection.
- Pb-free.
- The product itself will remain within RoHS compliant version.
- Compliance with EU REACH.
- Compliance Halogen Free .(Br<900ppm,Cl<900ppm,Br+Cl<1500ppm).
- Precondition: Bases on JEDEC J-STD 020D Level 3

Descriptions

The 99-218 series is available in soft orange, green, blue and yellow. Due to the package design, the LED has wide viewing angle and optimized light coupling by inter reflector. This feature makes the LED ideal for light guide application.

Applications

- LCD Back Light.
- Mobile phones.
- Indicators.
- Switch Lights.

Device Selection Guide

Chip Materials	Emitted Color	Resin Color
InGaN	Brilliant Green	Water Clear

Absolute Maximum Ratings (Ta=25°C)

Parameter	Symbol	Rating	Unit
Reverse Voltage	V_R	5	V
Forward Current	I_F	25	mA
Peak Forward Current (Duty 1/10 @1KHz)	I_{FP}	100	mA
Power Dissipation	P_d	95	mW
Operating Temperature	T_{opr}	-40 ~ +85	°C
Storage Temperature	T_{stg}	-40 ~ +90	°C
ESD	ESD	150	V
Soldering Temperature	T_{sol}	Reflow Soldering : 260 °C for 10 sec. Hand Soldering : 350 °C for 3 sec.	

Electro-Optical Characteristics (Ta=25°C)

Parameter	Symbol	Min.	Typ.	Max.	Unit	Condition
Luminous Intensity	I_v	180	-----	450	mcd	$I_F=5mA$
Viewing Angle	$2\theta_{1/2}$	-----	120	-----	deg	$I_F=5mA$
Peak Wavelength	λ_P	-----	518	-----	Nm	$I_F=5mA$
Dominant Wavelength	λ_d	520	-----	535	nm	$I_F=5mA$
Spectrum Radiation Bandwidth	$\Delta\lambda$	-----	35	-----	nm	$I_F=5mA$
Forward Voltage	V_F	2.50	-----	3.50	V	$I_F=5mA$
Reverse Current	I_R	----	----	50	μA	$VR=5V$

Notes:

1. Tolerance of Luminous Intensity: $\pm 11\%$
2. Tolerance of Dominant Wavelength : $\pm 1nm$
3. Tolerance of Forward Voltage: $\pm 0.1V$

Bin Range of Luminous Intensity

Bin Code	Min.	Max.	Unit	Condition
S1	180	225	mcd	$I_F = 5\text{mA}$
S2	225	285		
T1	285	360		
T2	360	450		

Note: Tolerance of Luminous Intensity: $\pm 11\%$

Bin Range of Dominant Wavelength

Groups	Bin Code	Min.	Max.	Unit	Condition
Y	X	520	525	nm	$I_F = 5\text{mA}$
	Y	525	530		
	Z	530	535		

Note: Tolerance of Dominant Wavelength : $\pm 1\text{nm}$

Bin Range of Forward Voltage

Groups	Bin Code	Min.	Max.	Unit	Condition
B17	9	2.50	2.70	V	$I_F = 5\text{mA}$
	10	2.70	2.90		
	11	2.90	3.10		
	12	3.10	3.30		
	13	3.30	3.50		

Note: Tolerance of Forward Voltage: $\pm 0.1\text{V}$.

Typical Electro-Optical Characteristics Curves

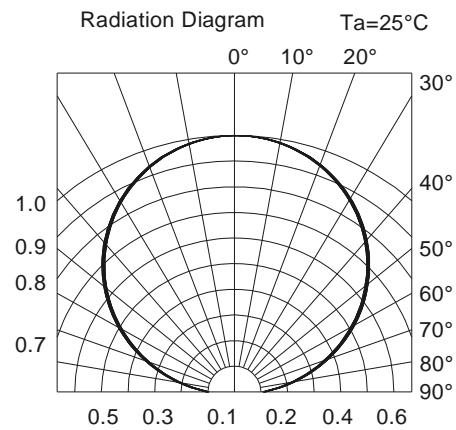
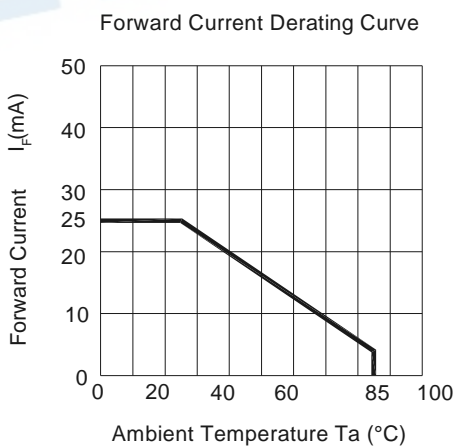
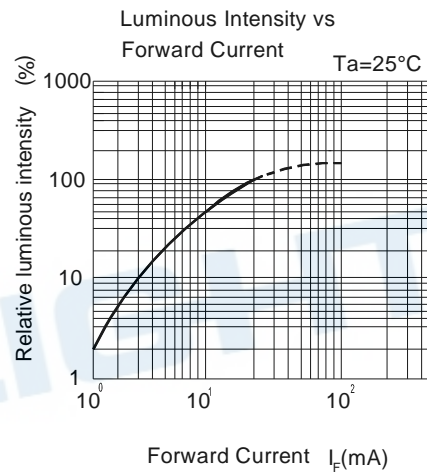
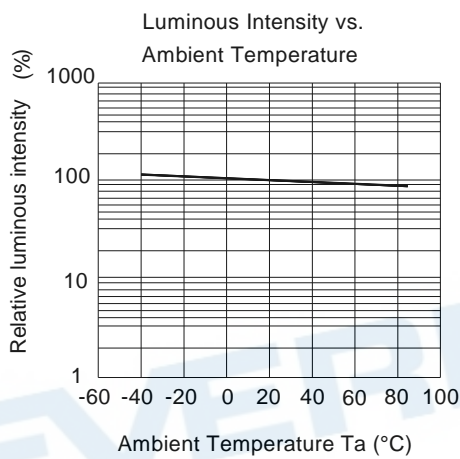
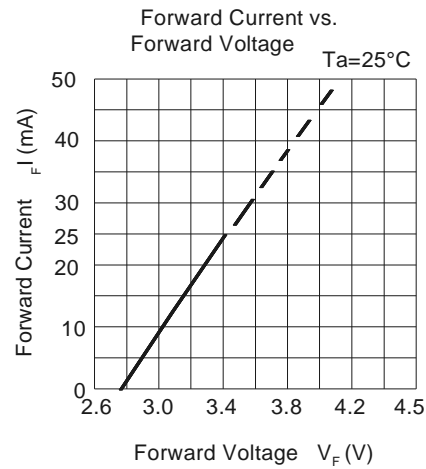
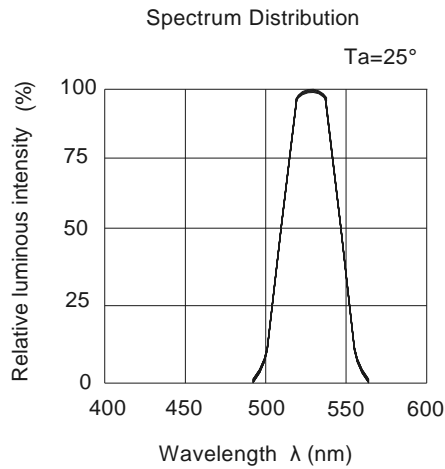

Package Dimension

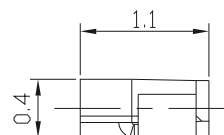
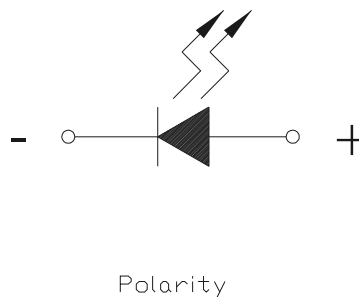
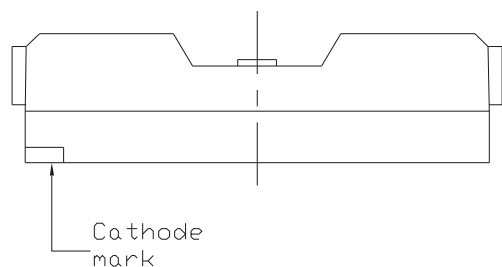

Recommended soldering pad design

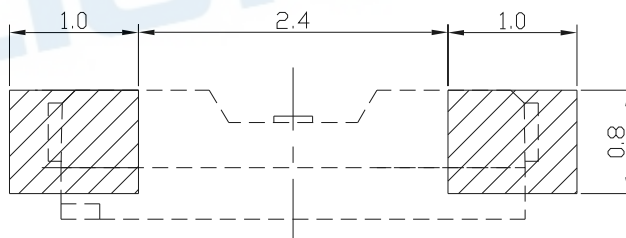
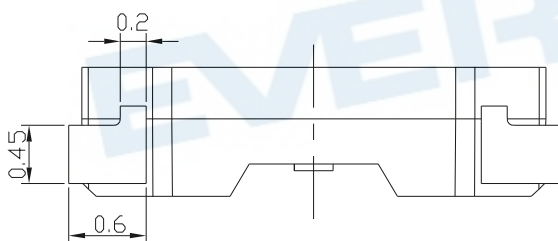

Note: Tolerances unless mentioned ± 0.1 mm. Unit = mm

Moisture Resistant Packing Materials

Label Explanation

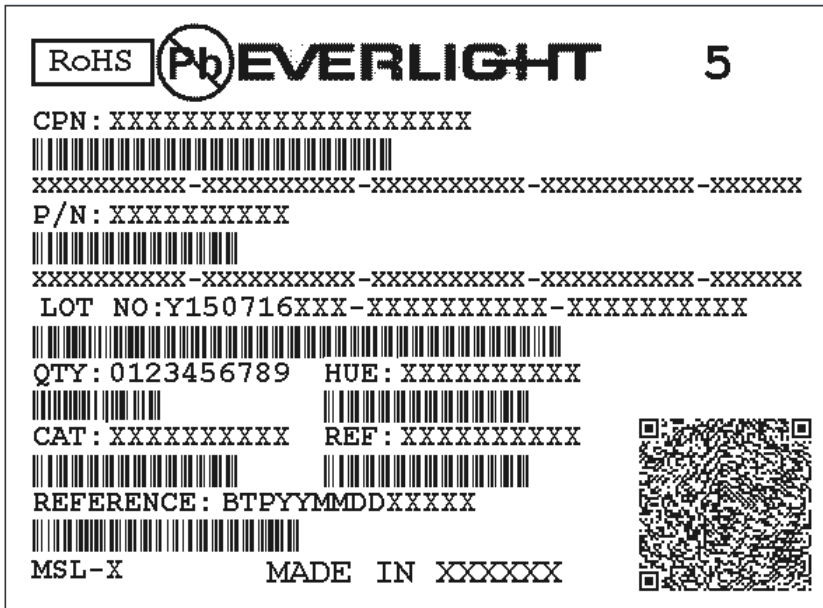

- CPN: Customer's Product Number
- P/N: Product Number
- QTY: Packing Quantity
- CAT: Luminous Intensity Rank
- HUE: Dom. Wavelength Rank
- REF: Forward Voltage Rank
- LOT No: Lot Number

Reel Dimensions

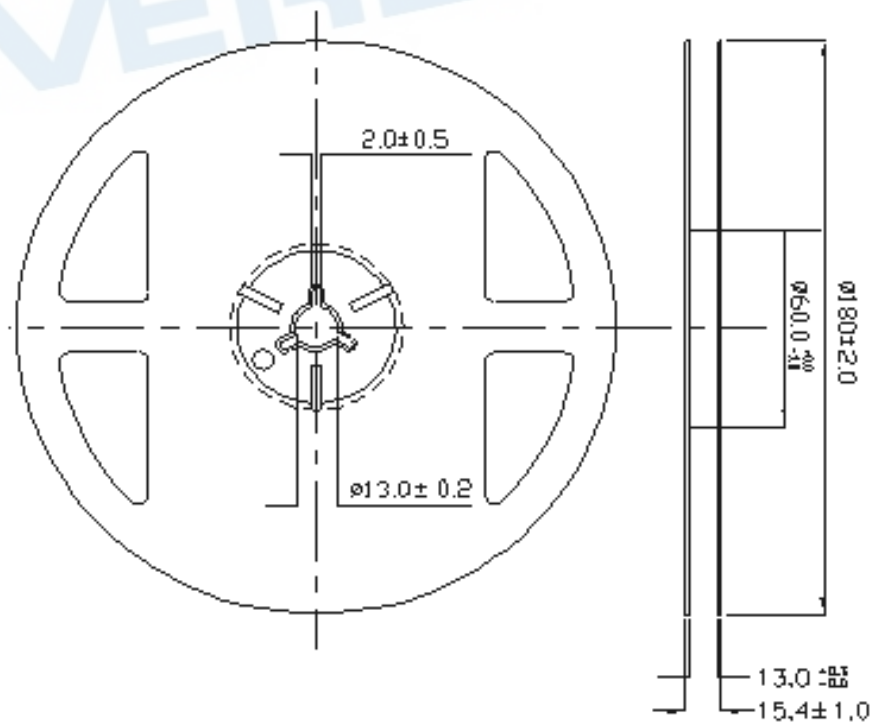

Note: Tolerances unless mentioned ± 0.1 mm. Unit = mm

Carrier Tape Dimensions; Loaded Quantity 2000 pcs Per Reel

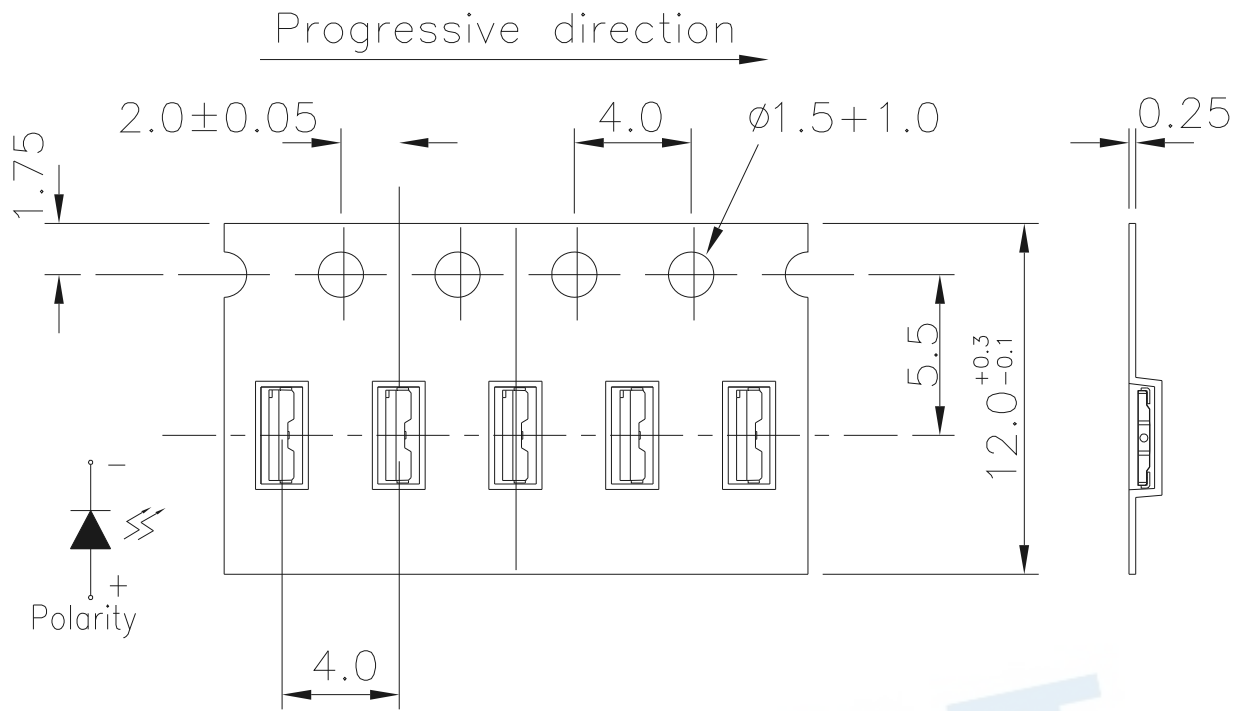

Moisture Resistant Packing Process

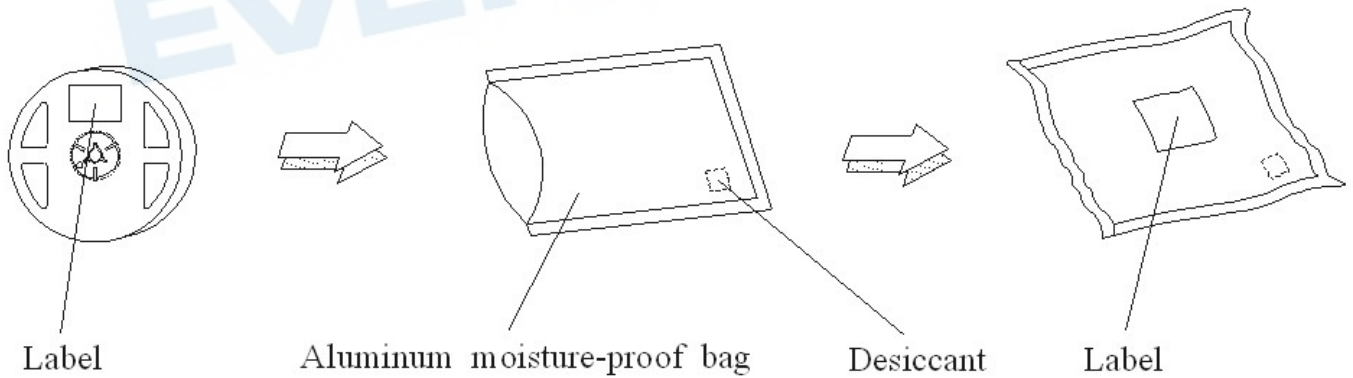

Precautions for Use

1. Over-current-proof

1.1 Customer must apply resistors for protection, otherwise slight voltage shift will cause big current change (Burn out will happen).

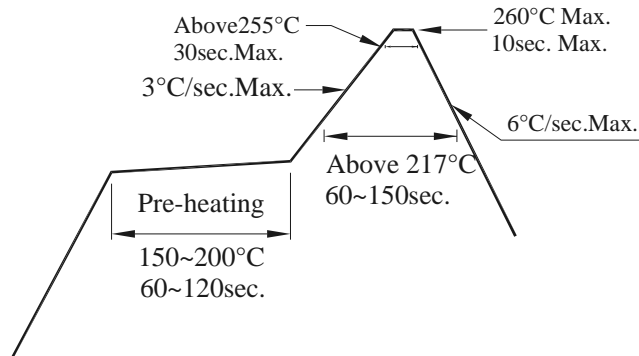

2. Storage

2.1 Moisture proof bag should only be opened immediately prior to usage.

2.2 Environment should be less than 30°C and 60% RH when moisture proof bag is opened.

2.3 After opening the package MSL Conditions stated on page 1 of this spec should not be exceeded.

2.4 If the moisture sensitivity card indicates higher than acceptable moisture, the component should be baked at min. 60deg +/-5deg for 24 hours.

3. Soldering Condition

3.1 Pb-free solder temperature profile

3.2 Reflow soldering should not be done more than two times.

3.3 When soldering, do not put stress on the LEDs during heating.

3.4 After soldering, do not warp the circuit board.

4. Soldering Iron

Each terminal is to go to the tip of soldering iron temperature less than 350°C for 3 seconds within once in less than the soldering iron capacity 25W. Leave two seconds and more intervals, and do soldering of each terminal. Be careful because the damage of the product is often started at the time of the hand solder.

5. Repairing

Repair should not be done after the LEDs have been soldered. When repairing is unavoidable, a double-head soldering iron should be used (as below figure). It should be confirmed beforehand whether the characteristics of the LEDs will or will not be damaged by repairing.

Application Restrictions

High reliability applications such as military/aerospace, automotive safety/security systems, and medical equipment may require different product. If you have any concerns, please contact Everlight before using this product in your application. This specification guarantees the quality and performance of the product as an individual component. Do not use this product beyond the specification described in this document.

DISCLAIMER

1. EVERLIGHT reserves the right(s) on the adjustment of product material mix for the specification.
2. The product meets EVERLIGHT published specification for a period of twelve (12) months from date of shipment.
3. The graphs shown in this datasheet are representing typical data only and do not show guaranteed values.
4. When using this product, please observe the absolute maximum ratings and the instructions for using outlined in these specification sheets. EVERLIGHT assumes no responsibility for any damage resulting from the use of the product which does not comply with the absolute maximum ratings and the instructions included in these specification sheets.
5. These specification sheets include materials protected under copyright of EVERLIGHT. Reproduction in any form is prohibited without obtaining EVERLIGHT's prior consent.
6. This product is not intended to be used for military, aircraft, automotive, medical, life sustaining or life saving applications or any other application which can result in human injury or death. Please contact authorized Everlight sales agent for special application request.