

Technical Data Sheet

Full Color Top View LEDs

67-23/REGBB7W-B32/2T

Features

- P-LCC-4 package.
- White package.
- Optical indicator.
- Colorless clear window.
- Ideal for backlight and light pipe application.
- Inter reflector.
- Wide viewing angle.
- Suitable for vapor-phase reflow.
- Computable with automatic placement equipment.
- Available on tape and reel (8mm Tape).
- Pb-free.
- The product itself will remain within RoHS compliant version.



Descriptions

- The 67-23 series is available in soft red, green, blue and yellow. Due to the package design, the LED has wide viewing angle and optimized light coupling by inter reflector. This feature makes the ideal for light pipe application. The low current requirement makes this device ideal for portable equipment or any other application where power is at a premium.

Applications

- Telecommunication: indicator and backlighting in telephone and fax.
- Flat backlight for LCD's, switches and symbols.
- Light pipe application.
- General use.

Device Selection Guide

| Chip | | Emitted Color | Resin Color |
|------|----------|-----------------|---------------|
| Type | Material | | |
| B7 | InGaN | Blue | White Diffuse |
| GB | InGaN | Brilliant Green | |
| RE | AlGaInP | Brilliant Red | |

Technical Data Sheet

Full Color Top View LEDs

67-23/REGBB7W-B32/2T

Package Outline Dimensions

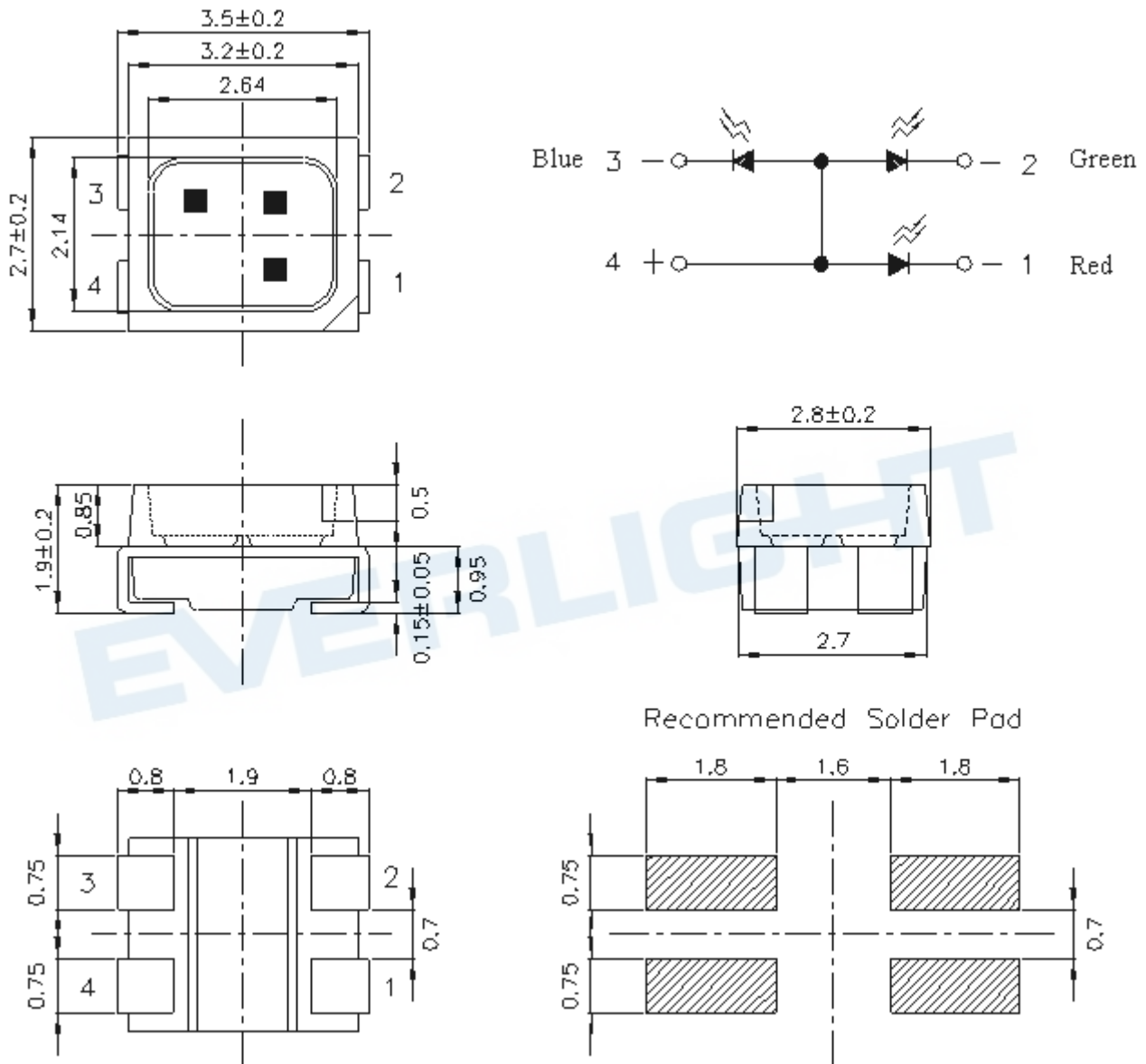

Note: The tolerances unless mentioned is: ± 0.1 mm; Unit = mm

Technical Data Sheet

Full Color Top View LEDs

67-23/REGBB7W-B32/2T

Absolute Maximum Ratings (Ta=25°C)

| Parameter | Symbol | Rating | Unit |
|--|----------|---|------|
| Reverse Voltage | V_R | 5 | V |
| Forward Current | I_F | B7 | 30 |
| | | GB | 30 |
| | | RE | 50 |
| Peak Forward Current(Duty 1/10 @ 1KHz) | I_{FP} | B7 | 100 |
| | | GB | 100 |
| | | RE | 100 |
| Power Dissipation | Pd | B7 | 110 |
| | | GB | 110 |
| | | RE | 120 |
| Electrostatic Discharge(HBM) | ESD | B7 | 1000 |
| | | GB | 1000 |
| | | RE | 2000 |
| Operating Temperature | Topr | -40 ~ +85 | °C |
| Storage Temperature | Tstg | -40~ +90 | °C |
| Soldering Temperature | Tsol | Reflow Soldering : 260 °C for 10 sec. Hand Soldering : 350 °C for 3 sec. | |

Technical Data Sheet

Full Color Top View LEDs

67-23/REGBB7W-B32/2T

Electro-Optical Characteristics (Ta=25°C)

| Parameter | Symbol | Min. | Typ. | Max. | Unit | Condition | |
|------------------------------|----------------|-------|-------|-------|-------|----------------------|----------------------|
| Luminous Intensity | I _v | B7 | 180 | ----- | 450 | mcd | I _F =20mA |
| | | GB | 715 | ----- | 1800 | | |
| | | RE | 360 | ----- | 900 | | |
| Peak Wavelength | λ _p | B7 | ----- | 468 | ----- | nm | I _F =20mA |
| | | GB | ----- | 518 | ----- | | |
| | | RE | ----- | 632 | ----- | | |
| Dominant Wavelength | λ _d | B7 | 464.5 | ----- | 476.5 | nm | I _F =20mA |
| | | GB | 520.0 | ----- | 535.0 | | |
| | | RE | 617.5 | ----- | 633.5 | | |
| Spectrum Radiation Bandwidth | Δλ | B7 | ----- | 25 | ----- | nm | I _F =20mA |
| | | GB | ----- | 35 | ----- | | |
| | | RE | ----- | 20 | ----- | | |
| Forward Voltage | V _F | B7 | 2.75 | ----- | 3.65 | V | I _F =20mA |
| | | GB | 2.75 | ----- | 3.65 | | |
| | | RE | 1.75 | ----- | 2.55 | | |
| Viewing Angle | 2θ 1/2 | ----- | 120 | ----- | deg | I _F =20mA | |
| Reverse Current | I _R | B7 | ----- | ----- | 50 | μA | V _R =5V |
| | | GB | ----- | ----- | 50 | | |
| | | RE | ----- | ----- | 10 | | |

Notes:

1. Tolerance of Luminous Intensity: ±11%
2. Tolerance of Dominant Wavelength: ±1nm
3. Tolerance of Forward Voltage: ±0.1V

Technical Data Sheet

Full Color Top View LEDs

67-23/REGBB7W-B32/2T

Bin Range of Luminous Intensity

| Symbol | | Bin Code | Min. | Max. | Unit | Condition |
|----------------|----|----------|------|------|------|----------------------|
| I _v | B7 | S1 | 180 | 225 | mcd | I _F =20mA |
| | | S2 | 225 | 285 | | |
| | | T1 | 285 | 360 | | |
| | | T2 | 360 | 450 | | |
| | GB | V1 | 715 | 900 | | |
| | | V2 | 900 | 1120 | | |
| | | W1 | 1120 | 1420 | | |
| | | W2 | 1420 | 1800 | | |
| | RE | T2 | 360 | 450 | | |
| | | U1 | 450 | 565 | | |
| | | U2 | 565 | 715 | | |
| | | V1 | 715 | 900 | | |

Bin Range of Dominant Wavelength

| Symbol | | Bin Code | Min. | Max. | Unit | Condition |
|----------------|----|----------|-------|-------|------|----------------------|
| λ _d | B7 | A9 | 464.5 | 467.5 | nm | I _F =20mA |
| | | A10 | 467.5 | 470.5 | | |
| | | A11 | 470.5 | 473.5 | | |
| | | A12 | 473.5 | 476.5 | | |
| | GB | X | 520 | 525 | | |
| | | Y | 525 | 530 | | |
| | | Z | 530 | 535 | | |
| | RE | E4 | 617.5 | 621.5 | | |
| | | E5 | 621.5 | 625.5 | | |
| | | E6 | 625.5 | 629.5 | | |
| | | E7 | 629.5 | 633.5 | | |

Notes:

1. Tolerance of Luminous Intensity: ±11%
2. Tolerance of Dominant Wavelength: ±1nm

Technical Data Sheet

Full Color Top View LEDs

67-23/REGBB7W-B32/2T

Typical Electro-Optical Characteristics Curves (B7)

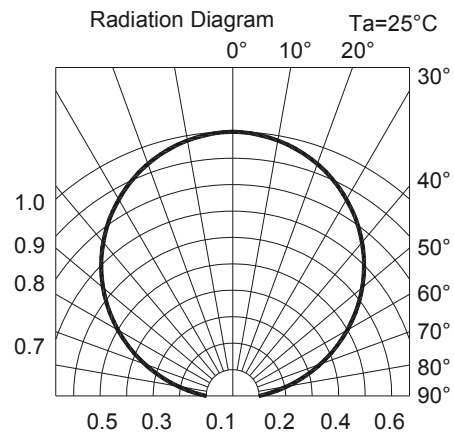
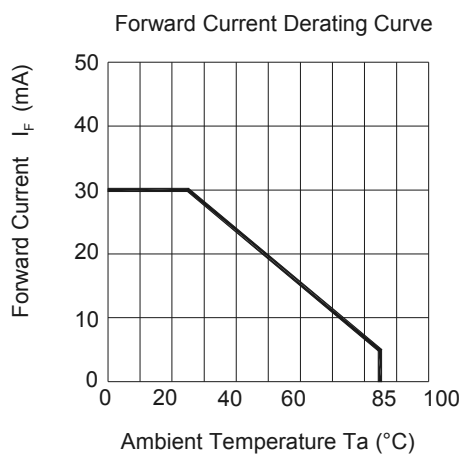
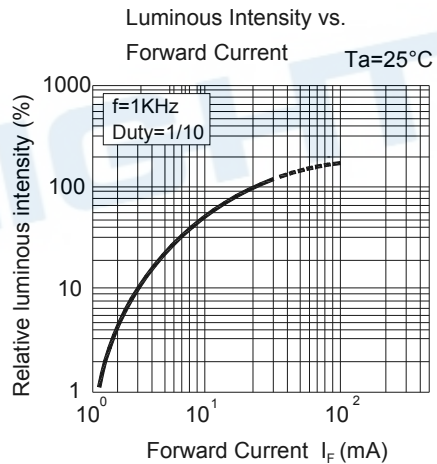
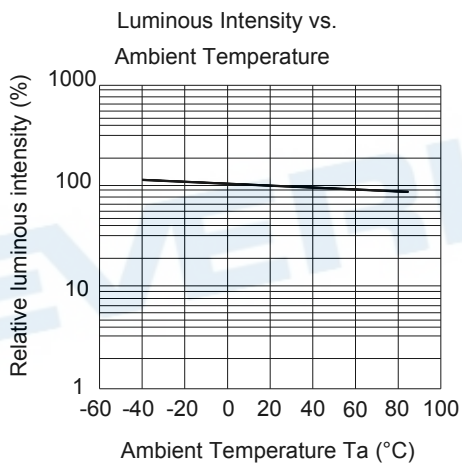
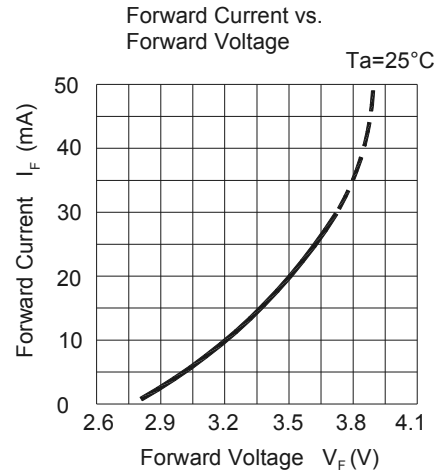
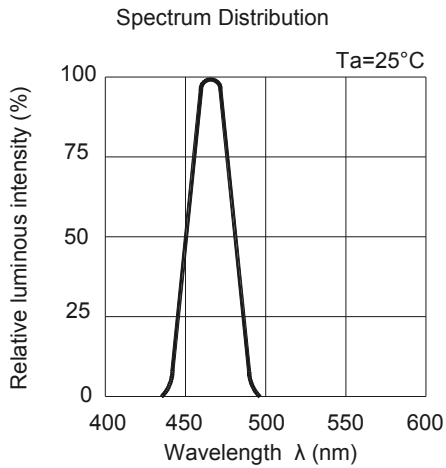

Technical Data Sheet

Full Color Top View LEDs

67-23/REGBB7W-B32/2T

Typical Electro-Optical Characteristics Curves (GB)

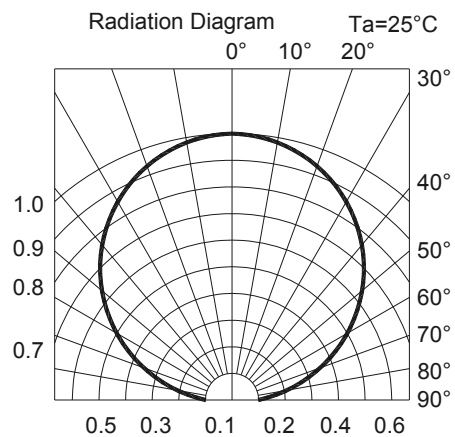
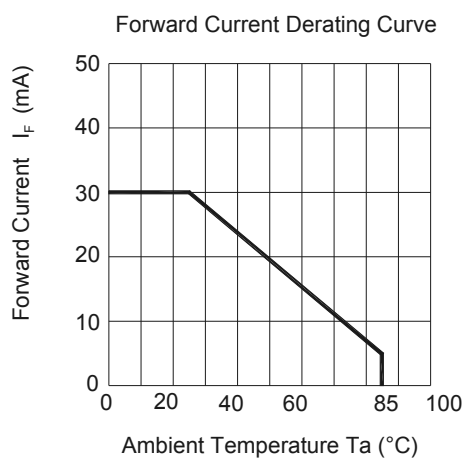
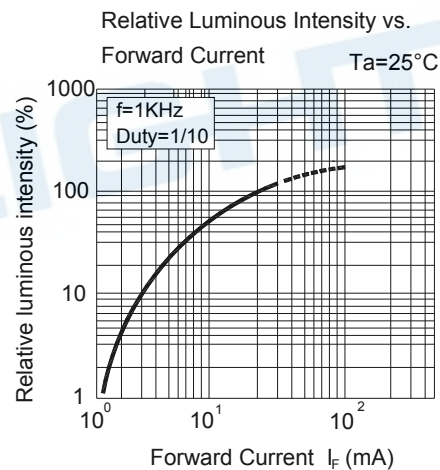
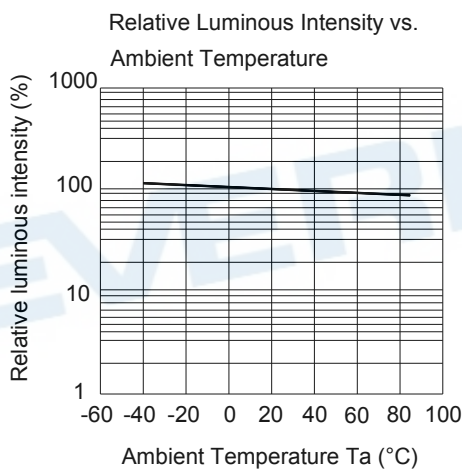
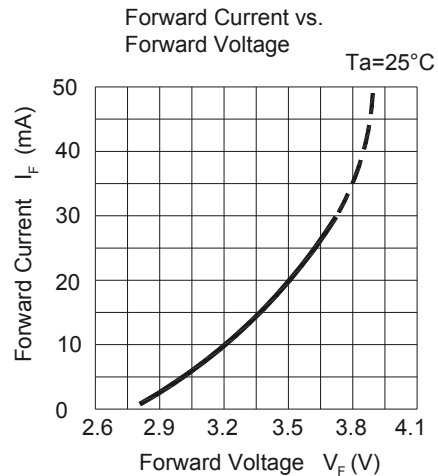
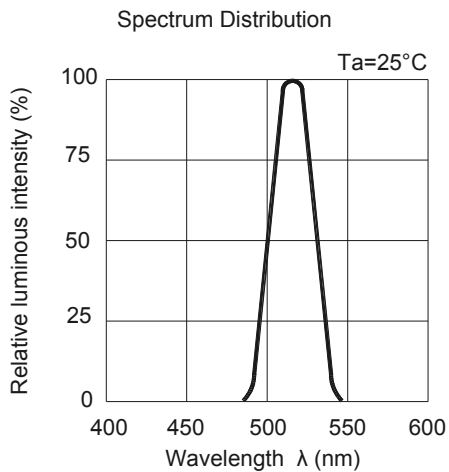

Technical Data Sheet

Full Color Top View LEDs

67-23/REGBB7W-B32/2T

Typical Electro-Optical Characteristics Curves (RE)

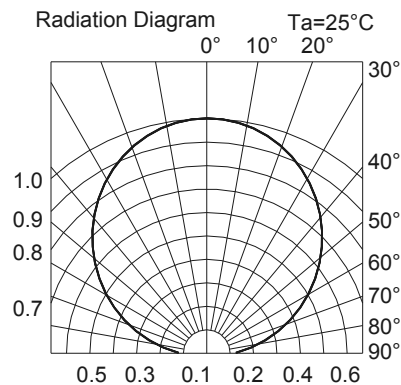
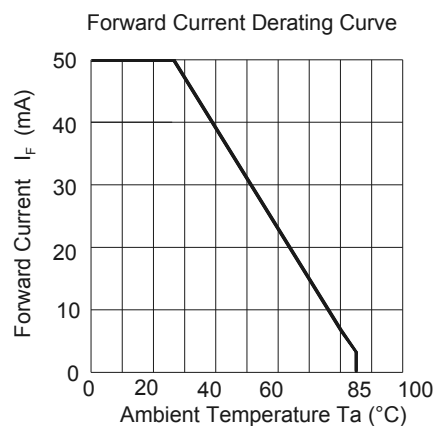
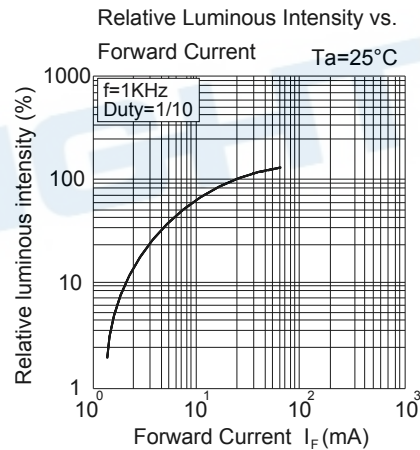
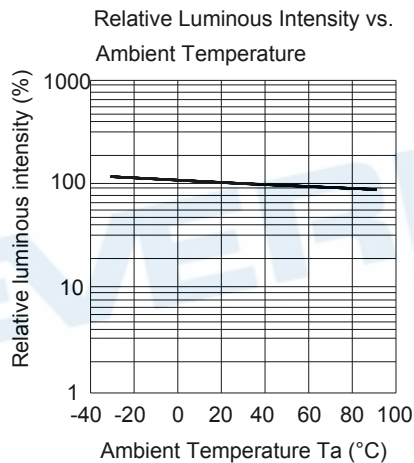
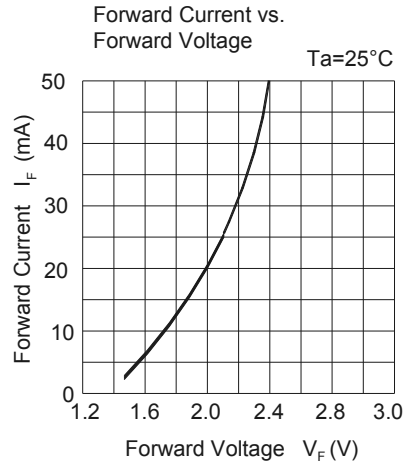
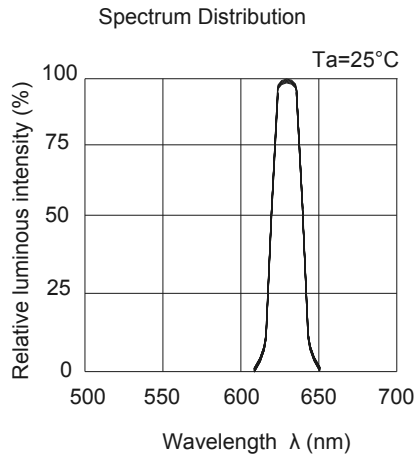

Technical Data Sheet

Full Color Top View LEDs

67-23/REGBB7W-B32/2T

Label Explanation

CAT: Luminous Intensity Rank
 HUE: Dom. Wavelength Rank
 REF: Forward Voltage Rank



Reel Dimensions

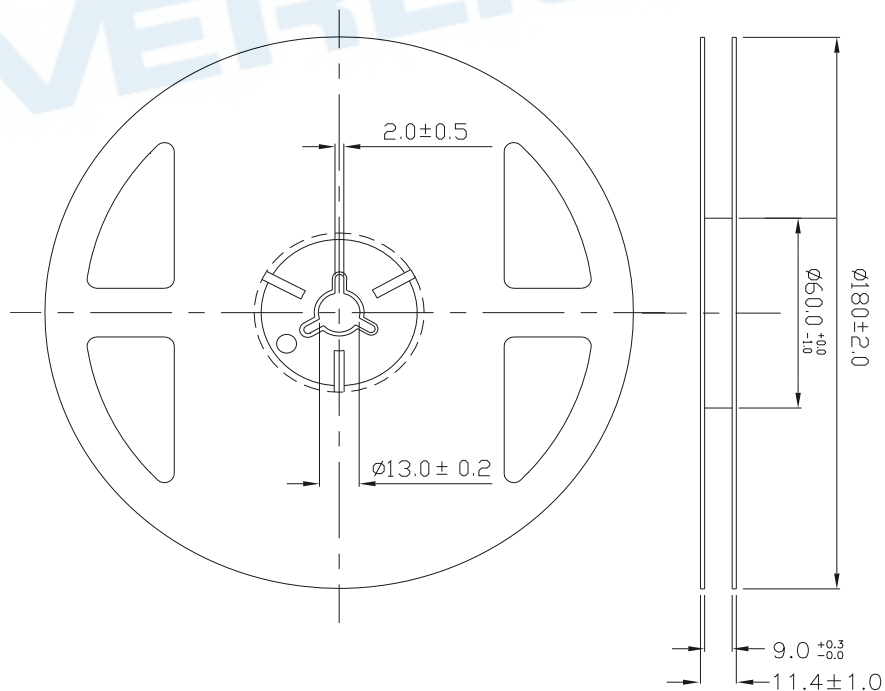

Note: The tolerances unless mentioned is: ±0.1mm; Unit = mm

Technical Data Sheet

Full Color Top View LEDs

67-23/REGBB7W-B32/2T

Carrier Tape Dimensions: Loaded Quantity 2000 PCS Per Reel.

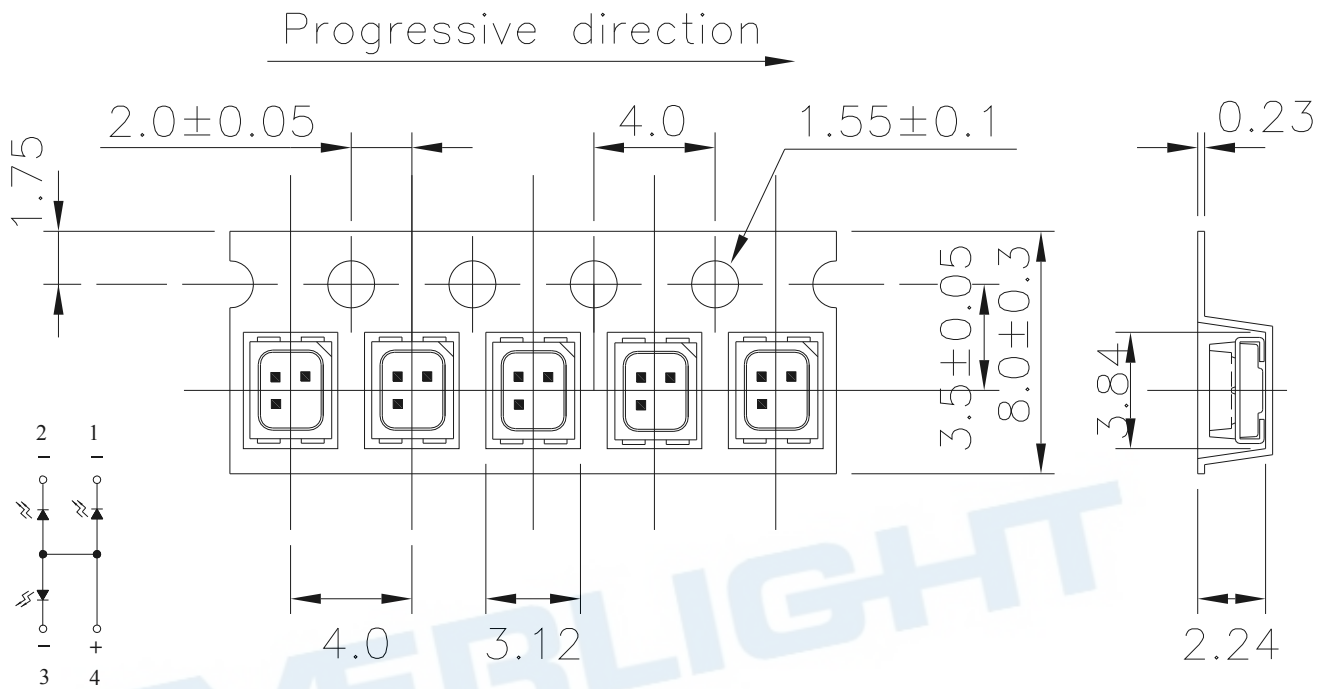

Note: The tolerances unless mentioned is: ± 0.1 mm; Unit = mm

Moisture Resistant Packaging

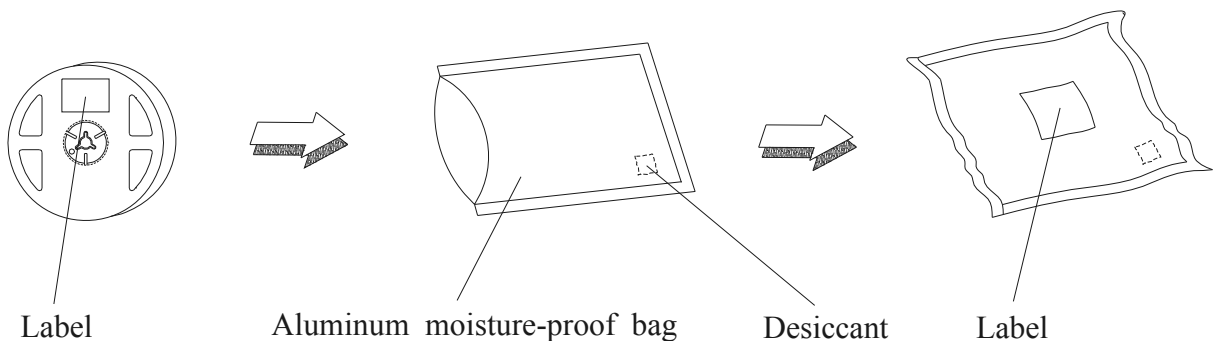

Technical Data Sheet**Full Color Top View LEDs****67-23/REGBB7W-B32/2T****Reliability Test Items and Conditions**

The reliability of products shall be satisfied with items listed below.

Confidence level : 90%

LTPD : 10%

| No. | Items | Test Condition | Test Hours/Cycles | Sample Size | Ac/Re |
|-----|----------------------------------|--|-------------------|-------------|-------|
| 1 | Reflow Soldering | Temp. : 260°C±5°C Max 10 sec. | 6 min | 22 PCS. | 0/1 |
| 2 | Temperature Cycle | H : +100°C 15min ↓ 5 min L : -40°C 15min | 300 Cycles | 22 PCS. | 0/1 |
| 3 | Thermal Shock | H : +100°C 5min ↓ 10 sec L : -10°C 5min | 300 Cycles | 22 PCS. | 0/1 |
| 4 | High Temperature Storage | Temp. : 100°C | 1000 Hrs. | 22 PCS. | 0/1 |
| 5 | Low Temperature Storage | Temp. : -40°C | 1000 Hrs. | 22 PCS. | 0/1 |
| 6 | DC Operating Life | I _F = 20 mA | 1000 Hrs. | 22 PCS. | 0/1 |
| 7 | High Temperature / High Humidity | 85°C/85%RH | 1000 Hrs. | 22 PCS. | 0/1 |

Technical Data Sheet

Full Color Top View LEDs

67-23/REGBB7W-B32/2T

Precautions for Use

1. Over-current-proof

Customer must apply resistors for protection, otherwise slight voltage shift will cause big current change (Burn out will happen).

2. Storage

2.1 Do not open moisture proof bag before the products are ready to use.

2.2 Before opening the package: The LEDs should be kept at 30°C or less and 90%RH or less.

2.3 After opening the package: The LED's floor life is 168 hours under 30°C or less and 60% RH or less.

If unused LEDs remain, it should be stored in moisture proof packages.

2.4 If the moisture absorbent material (silica gel) has faded away or the LEDs have exceeded the storage time, baking treatment should be performed using the following conditions.

Baking treatment : 60±5°C for 24 hours.

3. Soldering Condition

3.1 Pb-free solder temperature profile

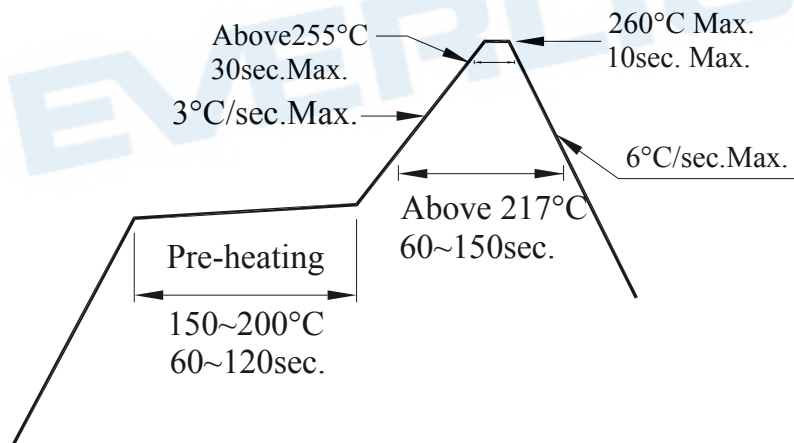

3.2 Reflow soldering should not be done more than two times.

3.3 When soldering, do not put stress on the LEDs during heating.

3.4 After soldering, do not warp the circuit board.

Technical Data Sheet

Full Color Top View LEDs

67-23/REGBB7W-B32/2T

4. Soldering Iron

Each terminal is to go to the tip of soldering iron temperature less than 350°C for 3 seconds within once in less than the soldering iron capacity 25W. Leave two seconds and more intervals, and do soldering of each terminal. Be careful because the damage of the product is often started at the time of the hand solder.

5. Repairing

Repair should not be done after the LEDs have been soldered. When repairing is unavoidable, a double-head soldering iron should be used (as below figure). It should be confirmed beforehand whether the characteristics of the LEDs will or will not be damaged by repairing.

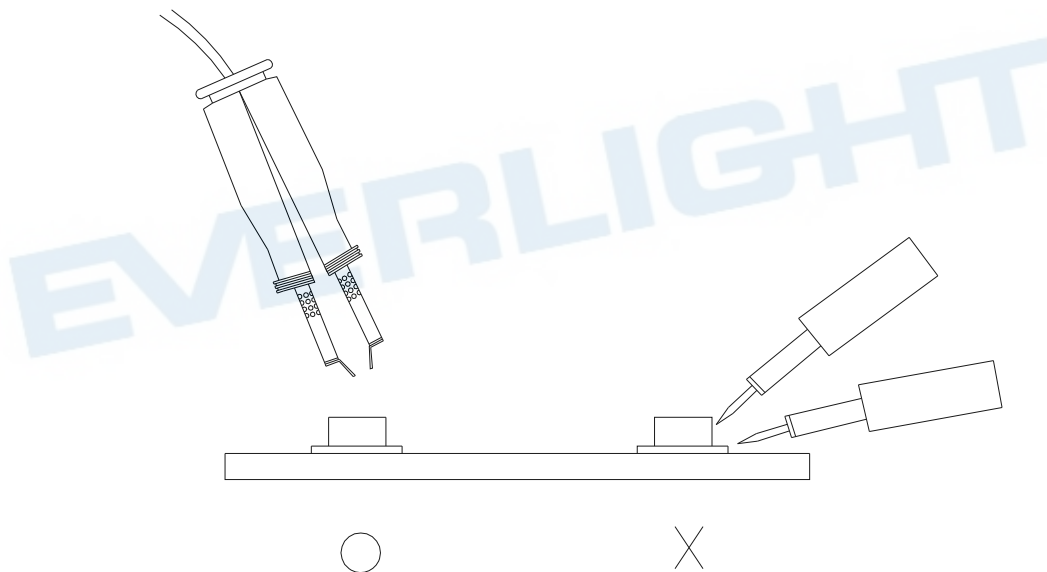

Technical Data Sheet

Full Color Top View LEDs

67-23/REGBB7W-B32/2T

DISCLAIMER

1. EVERLIGHT reserves the right(s) on the adjustment of product material mix for the specification.
2. The product meets EVERLIGHT published specification for a period of twelve (12) months from date of shipment.
3. The graphs shown in this datasheet are representing typical data only and do not show guaranteed values.
4. When using this product, please observe the absolute maximum ratings and the instructions for using outlined in these specification sheets. EVERLIGHT assumes no responsibility for any damage resulting from the use of the product which does not comply with the absolute maximum ratings and the instructions included in these specification sheets.
5. These specification sheets include materials protected under copyright of EVERLIGHT. Reproduction in any form is prohibited without obtaining EVERLIGHT's prior consent.
6. This product is not intended to be used for military, aircraft, automotive, medical, life sustaining or life saving applications or any other application which can result in human injury or death. Please contact authorized Everlight sales agent for special application request.

EVERLIGHT ELECTRONICS CO., LTD.
Office: No 25, Lane 76, Sec 3, Chung Yang Rd,
Tucheng, Taipei 236, Taiwan, R.O.C

Tel: 886-2-2267-2000, 2267-9936
Fax: 886-2267-6244, 2267-6189, 2267-6306
<http://www.everlight.com>